

# The SDA Newsletter

THE QUARTERLY NEWS MAGAZINE OF SOFTWARE DESIGN ASSOCIATES, INC.

VOLUME X

SPRING 1984

NO. 2

## SDA PARTY CREATES HAVOC ON THE EAST COAST

Meteorologists should take a look at SDA's spring party schedule before releasing any weather forecasts for that time of the year, as SDA's spring parties have a tendency to bring winter back with a vengeance.

1984 was no exception in New York. The annual spring fling brought down torrents of rain, sleet, hail and snow; high winds; and the lowest barometric pressure in 50 years.

While all these bearish things were happening outside, SDA New Yorkers were having a bullish and fullish and not at all dullish time within the comfortable confines of the Swiss Bear Restaurant.

High pressure fronts swirled in upon the bar and the buffet, which were, as in past years, reservoirs of good booze and varied and delicious foods. Low pressure fronts descended upon the dining tables--for a while, at least. Then the fronts

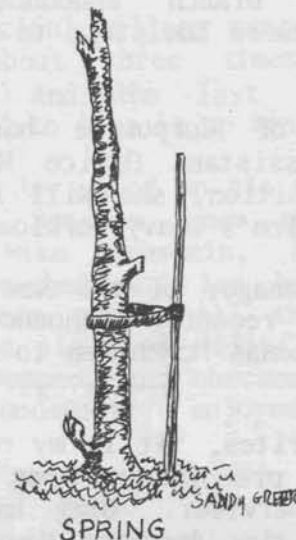
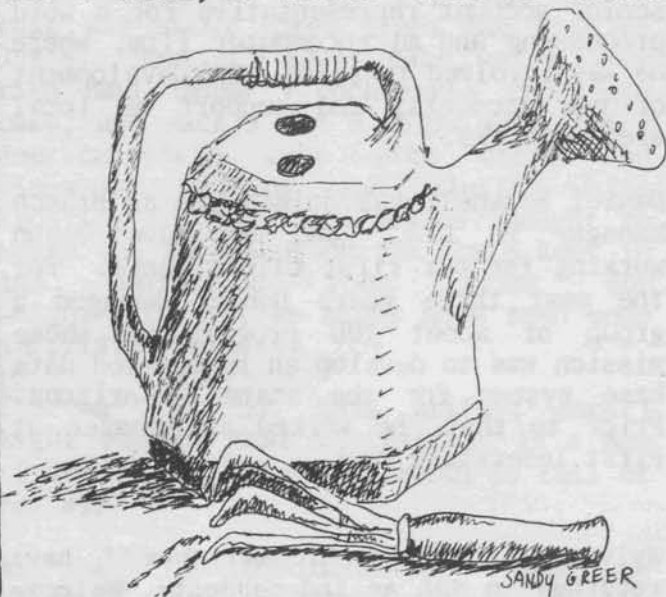

met, and a storm of mastication, tipsification and conversation filled the area.

The eye of the storm arrived in the person of Suzanne Wachler, fair, blue-eyed and radiant, and full of talk and pictures of her infant son, who looks both bonnie and bright.

After the eye had passed, the storm quieted down, leaving little pockets of



THE SDA NEWSLETTER  
71 Fifth Avenue  
New York, NY 10003

Publisher:	Jay Goldberg
Editor:	Jane Braik
Assistant Editor:	Paul Kavanagh
Staff Artists:	Patri Tiberi Sandy Greer Rose Heibendahl Rita Kelly
Production Manager:	Suzanne Wachler

turbulence scattered about the room and quickly dissipated by homeward flurries and flurries to neighborhood bars.

## Promotions

On March 1st TM June Muller of the New York Downtown branch announced the promotion of Laurie Edelstein to Account Supervisor.

Patri Tiberi of Corporate has been promoted to Assistant Office Manager. In her new position, she will help to ease Denise Whalen's heavy workload.

David Forst, manager of the New Jersey North branch, recently announced the promotion of Thomas McMenimen to Account Supervisor.

Marty Aronow writes, "It is my pleasure to announce the promotion of Greg Randall to Account Supervisor. Greg has been splitting his time between New Jersey and Florida over the past few months. Effective April 1, 1984, he will relocate to Jacksonville, Florida, to assume his increased responsibilities." Marty, as you all know, is manager of the New Jersey Central branch and Vice President of the Atlantic Region.

We offer Laurie, Patri, Thomas and Greg our sincere congratulations and wish them continued success in the future.

## Comings & Goings

Since Suzanne Wachler left on her maternity leave of absence toward the end of February, Patri Tiberi has been taking her place as Jay Goldberg's secretary. Suzanne plans to return around the end of May.

On March 19th Ira Gleser joined SDA as Marketing Assistant. According to Ron Episcopo, "Ira has earned an MBA from George Washington University in Washington, D.C., with a concentration in Marketing. For his graduate thesis he developed a proposal for the promotional

campaign of a major housing development in Washington. Ira's most recent assignment was as Marketing/Sales Administrator for a successful firm located in the Washington area. In addition, he was chosen as one of 13 interns for AT&T's 1982 sales training program out of more than 400 applicants."

On April 1st Sheryl Franklin was named Account Executive at our Philadelphia branch. According to Branch Manager Tom McGlensey, "Sheryl has been with SDA for nearly three years, during which time she served as Account Supervisor and then as Technical Manager. She is a credit to our branch, as is evidenced by her upward career growth. She has done an excellent job as TM, so please join me in congratulating Sheryl in her new position."

Rita Estevez of Corporate has been named Training Coordinator.

Paula Lubrano has taken over Rita's former position as Recruiter.

Loretta Barnes has joined the Personnel Department to take over Paula's former position. Loretta's previous experience was in security for several retail and private investigative firms.

Cory Lynn has joined the New York Downtown branch as Account Executive. Before coming to SDA, Cory worked as a senior account representative for a word processing and microcomputer firm, where he was involved in sales, the development of new accounts, and support of local area networks.

Daniel Brownell has joined SDA as Branch Manager in L.A., and we have begun working for our first client there. For the past three years Daniel managed a group of about 100 programmers whose mission was to develop an integrated data base system for the state of Arizona. Prior to that, he worked as manager at First Interstate Bank.

Sylvia Baltin and Michael Zumoff have returned to SDA as independents. Welcome back, Sylvia and Mike.

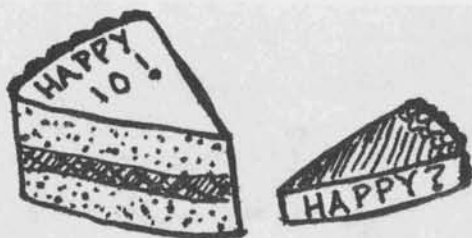

### WILL THE REAL JG STAND UP?

On Friday, March 23rd, a late afternoon Corporate sales meeting was abruptly broken up by a festive procession making its way into the conference room, led by Gloria Beamon bearing a large cake. Gloria was closely followed by Steve Huvane, carrying another cake, and Patri Tiberi with a bottle of champagne sporting a bright balloon. The occasion? Jay Goldberg's birthday and Jack Geringer's tenth anniversary with SDA. More champagne followed, and a jolly party ensued.

Rumor has it that Jay and Jack knew of the plan beforehand, but each thought that the party was to be for the other. Clever planning on somebody's part!

Cards were presented to the two guests of honor, with messages from all the staff. Mike Ornstein had the effrontery to write "I thought you retired last year" on Jack's.

It was noticed by all, and mentioned by those who dared to say it, that Jack's cake was about three times the size of Jay's. However, Jay's cake was a very rich and dense French-style chocolate cake, and Jack's was a light and fluffy American-style cake with cream and pineapple filling and fluffy white frosting on top. Had anyone thought to weigh the two cakes on the scale kept in the conference room corner for weight-watchers, we might have seen some surprising results.

Someone (but not this writer, Jack!) might comment that a president is a man of substance while a salesman is full of hot air.

All weighty considerations aside, we offer both JG's our hearty congratulations.

### A SHOWER FOR SUZANNE

On the afternoon of February 3rd, the conference room was gaily decorated, and almost everyone who works at Corporate assembled to treat mother-to-be Suzanne Wachler to a baby shower. Yes, almost everyone--except Suzanne and her boss, Jay Goldberg, who was supposed to lead her in.

The fanciful balloon centerpiece fell down about three times while we waited, and the last time nobody bothered to tape it up again.

Finally Jay wound up his meeting and, sending Suzanne down the hall to fetch Mike Ornstein, he sneakily followed her and led her into the conference room. All the assembled breathed sighs of relief. Champagne corks popped, and obscenely rich ice cream sundaes were enjoyed by all.

Toward the end of the festivities, Suzanne opened her gifts, which included a car seat, a baby swing, and a portable tote-bag/baby-bed, in addition to many smaller-sized gifts from various members of the Corporate staff.

At the end of the party Suzanne had a big glow on her face and big pile of presents to bring home.

### SDA EMPLOYEE BREAKS THE CW BARRIER

Doug Jerger, our Midwest Region Vice President, was recently quoted in Computerworld. As chairman of Adapso's CPA Relations Committee, Doug has been leading other concerned Adapso members in a campaign to persuade the SEC to "rule on the propriety of certified public accounting firms selling DP services to companies that they also audit."

In this computerized age, auditors no longer examine manually prepared books. Instead, they pore over computer printouts and check out the accuracy of computer systems. When these systems and reports were designed and marketed by the auditing

firm's own staff, there is the possibility of a conflict of interest, and the law requires that auditors be truly independent.

For a while it was open war. But recently cooperative negotiations has brought about a cease-fire, and Adapso has been negotiating with the big auditing firms.

"It was always the intention of the CPA Relations Committee to establish a dialogue with the accounting firms," Jerger is quoted as saying. "We now have that dialogue, and we hope the relationship will blossom and that we can coexist in a way that is beneficial to all of us."

Litigation to force auditing firms to withdraw from the DP services market has not been abandoned, but rather put on hold until further information has been gathered and analyzed.

"This is not a simple, clear-cut issue," Jerger was further quoted. "It is one that is difficult to handle in a way that is fair and straightforward, and as we talk, the positions of the respective parties are changing as they come to appreciate the other guy's point of view."

The hoped-for result of this research and negotiation is decisions based on "real information" which will "bring this episode to its conclusion."

Readers, what do you think? Should auditors audit their own software packages? If they do, is there some way of ensuring that the audits be fair and impartial? That the auditors be "truly independent"? Write in your opinions on this very important issue--remember, we do have a Feedback (letters to the editor) column, which is all too rarely used as a forum for discussion of meaningful issues. As an example of the triviality to which this column has descended, see "Feedback" in this very issue.

**SDA  
IS AN EQUAL OPPORTUNITY EMPLOYER  
M/F**

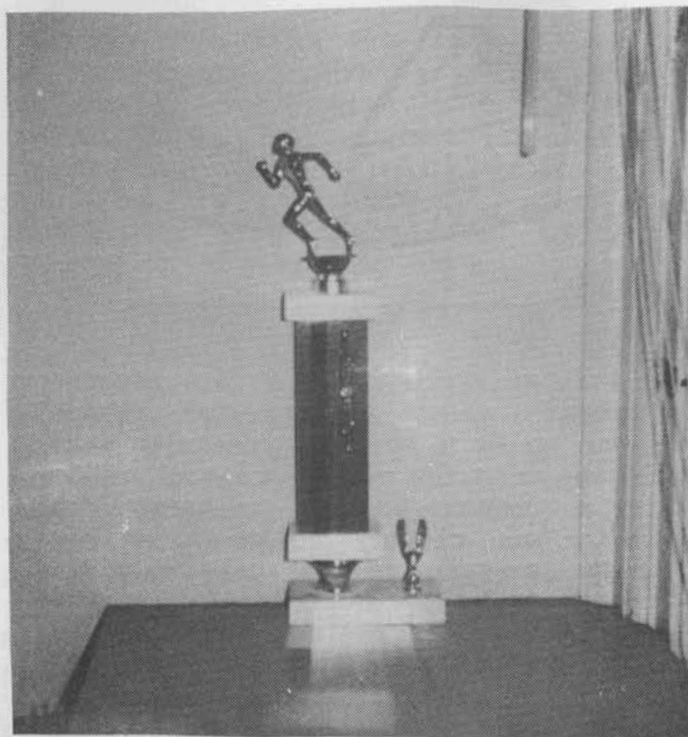

#### SANDY'S A WINNER

On April 8th Sandy Greer took third place in the Runners Love Brooklyn 10K race, running in the Vet A class (women of ages 40 to 44). Her time was 48:20.

#### RECENT REFERRALS

Beginning with this issue, we are publishing the names of all SDA employees who have referred to us job applicants who were subsequently hired by SDA. Since this is the first in the series, it may not include all referrals since the publication of the last issue, so don't feel bad if your name is left out.

Well, here goes!

Sponsor	Referral
D. Chandrasekar	Dilip Deodhar
Don Wright	Jerry Burnaugh
Doreen Lehmann	Patrick Quigley IV
Rita Kelly	Loretta Barnes

We thank all the sponsors, and we heartily welcome all the referrals to SDA, the "company with a heart."

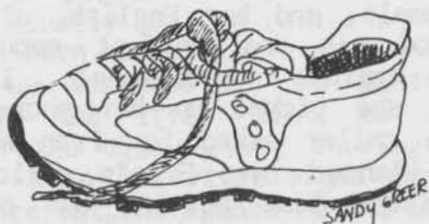

## LET'S HIT THE ROAD!

Sandy Greer

Spring is in the air, the birds are singing, and it's time to get on your running shoes. Run for fun, run to lose weight, run to meet people, run to calm your mind. The best seasons for running are spring and fall, so let's get out there!

This year will be the fourth year of SDA participation in the Manufacturers Hanover Corporate Challenge. Art Villafane and I alternate years on the paperwork, as co-captains of the SDA team. We hope that a lot of you, especially the new people, will try this fun event. We have to have enough people to form teams, which consist of five men or three women or (two men and two women).

The races consist of 3-1/2 miles in Central Park at 7 pm or thereabout on three weeknights. The dates are:

Wednesday, June 20  
 Tuesday, July 10  
 Tuesday, August 7

Generally we are allowed to enter only two races because there are so many participants.

We meet in the park at our special place with our banner and a shopping cart full of beer and other refreshments brought over by Art. The fast men (faster than a 7-minute mile) run first, then the women, then all the other men. Everyone wears a corporate T-shirt. We keep our own scores

and the captains tally them on cards. Then everyone sits around and drinks beer until it's too dark to see anything.

Anyone can run 3-1/2 miles; one year we had Suzanne and Denise competing, and they hadn't even practiced. Older folks like myself should try doing a mile every second day for a couple of weeks. That's how I got started running -- preparing for the first Corporate Challenge that SDA participated in. Then I just kept doing it. Now I do four miles almost every day.

If you would like to race with us, leave your name with your TM or call Art or me. We usually recruit our runners when they are a little high at the spring party, but not enough people showed up for the races last year from that bunch. So this year we are looking for a more committed group.

Note to sales staff: Competing in this race lets you see a lot of potential and actual clients. Also, your competitive nature makes you good team members. We would really like to have you run.

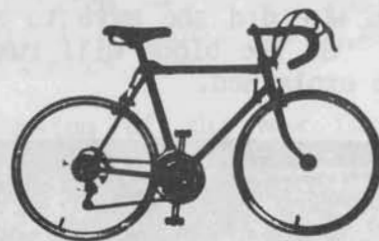
CYCLISTS, TAKE NOTE

With bicycling season and warmer weather around the corner the idea has occurred to a few staff members to form a cycling team that would enter into various cycling events. The first event is the 5 Borough Bike Tour sponsored by CitiBank on April 29 (Sunday) which is a 36 mile ride around New York City. Another event is the Pepsi challenge held on memorial day weekend. Anyone interested in joining can contact Steve Schwartz or Win Ferrell through the Corporate office.

Steve Schwartz

# SDA Gossip

Edited by Belotha Belt

Rose Heibendahl of Payroll recently inserted a dollar bill in a change machine and, instead of change, five dollar bills came out. In went another, and out came two! At this point the law of diminishing returns took over, and no more dollars were forthcoming.

About 32 people recently gave a luncheon for Benito Sim of the New York technical staff on the occasion of his leaving a client account. After all the toasts and farewells, the client decided to keep him on for a while longer. But the 32 didn't mind a bit--it was just an excuse for another luncheon in the future!

When New York Account Executives Mary Johnston and Ron Romano began sharing an office, Mary made a rather unusual request of Ron. "Would you mind standing guard outside the door for a few minutes?" she asked. "I have to stand on my head, and I'm wearing a skirt." Ron obliged, wondering why she was so confident that he wouldn't take a peek. And why did she have to stand on her head? "So the blood will rush to my head," she explained.



Maritza Strohbach of Accounting was born

in Guatemala, and her English, although very good, is not perfect enough to ensure against occasional lapses. Recently she picked up her phone and, when the caller asked for Fran Wallis, Maritza glanced into Fran's office and said, "She's just getting out of her desk."

Tom Cleary of the New York technical staff was recently on down time for a few days. When told, "I knew you were here because I heard your laugh, and your laugh is unique," Tom replied, "I'm not here. I taped it."

Saadet Can of Word Processing hails from Turkey, and she is very proud of her national origin. Norman Merkin happened to walk past her office at lunch time recently and, seeing her preparing a meal of yogurt, hot peppers and other exotic ingredients, asked, "Are you fixing yourself some Greek food?" Then he wondered why she looked daggers at him. Then, just to make us look like liars, he shaved off all his whiskers right after this picture was taken.

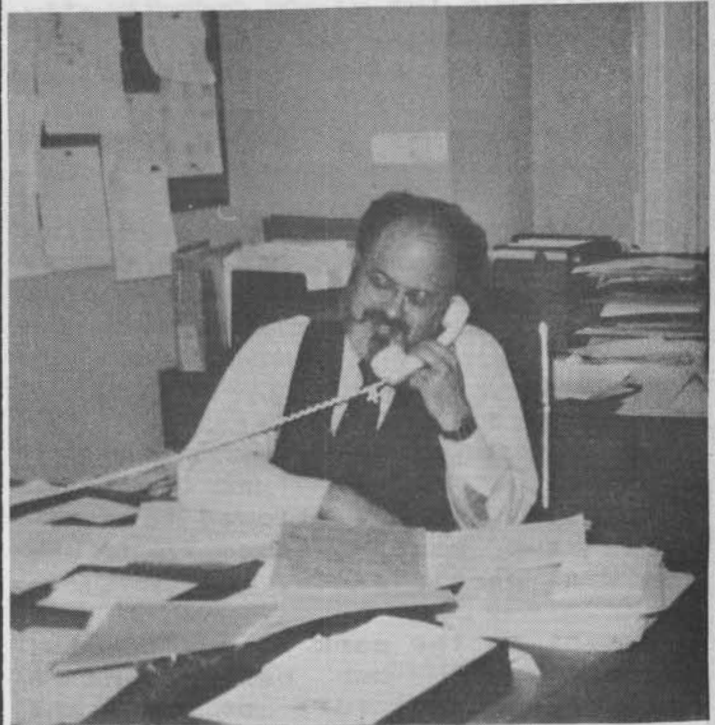

Fate played a cruel April Fool joke on our Wang VS 80. It was in robust health at the end of March; by Monday morning, April 2nd, it was totally unable to function, and its screens displayed a

greenish pallor. When the computer doctor finally arrived (after an off-duty one had been beeping for over two hours by Wang's new computerized call distribution system), the first thing he did was examine the disk drive, fearing a head crash. When all vital signs were found to be present, he opened up the CPU. And what beautiful innards were disclosed! At the bottom was a horizontally fixed "mother" board, and floating in the ethereal space above it were the lesser circuit boards, glinting in intricate patterns of blue and green and red and hanging in the wind like exotic garments on parallel clotheslines. The doctor determined that an organ transplant was needed and rushed off in search of a suitable donor. He returned shortly afterward with a healthy circuit board and replaced the diseased one in a matter of minutes. The greenish pallor was soon replaced by a healthy menu, and the VS began gobbling up data with robust appetite. So far, no symptoms of tissue rejection have been observed.

Jay Goldberg has decided to go out on billing. In preparation, he is practicing on a PC at his desk. We predict that, in less than 15 years, he'll be promoted to Account Supervisor.



Question of the quarter: Who left the following cryptic message on the conference room table at 71 Fifth Avenue--"I would like to relate an incident which happened a long time ago but influenced my relationships until this day."???

Second question of the quarter: Who sent Seth Hanover a bunch of flowers with a card reading "From a secret admirer"?

For more gossip, see "News from Norton."

## Social Notes

Darren Yuan and his wife Hiaw-Ta are the proud parents of a beautiful bouncing boy, Anthony, born on February 12th and weighing in at 7 pounds 4 ounces. Both mother and son are doing well. Darren is a member of the New Jersey North technical staff.

On March 10th Ed Skutecki of the New York technical staff was married to Yanick Francoeur.

Suzanne and Larry Wachler are the delighted parents of a son, Justin Scott, who arrived on March 11th weighing 8 pounds 2 ounces.

Mary Johnston of the New York Midtown sales force is a lyrical soprano who frequently performs in opera. Recently she played the part of the countess in Mozart's "The Marriage of Figaro" at the Theater Opera and Music Institute. She has also performed with the New York Lyric Opera and the Amato Opera.

On March 19th Jane Braik's daughter Victoria announced her engagement to Paul Bourget. Vicky and Paul are co-owners of a small recording studio in Tucson, Arizona.

On April 17th Linda Gasbarro gave birth to a baby boy, Timothy John, who weighed in at 8 pounds 7 1/2 ounces and measured 22 inches. We wish both mother and son much joy.

MEET STEVE DANSIGER,  
PART-TIME EMPLOYEE,  
BIG-TIME ENTERTAINER

When Stephen Dansiger works at Corporate three days a week, it seems to him as if everyone is his boss and he's the only flunkie. Steve, the son of Sheldon Dansiger and a student at Jersey City State College, works part time at Corporate performing miscellaneous clerical tasks.

Outside of working hours, however, Steve is an artist and an entrepreneur, specializing in rock music (he is a drummer) and acting.

The first band he organized and played in is called You Suck. It produced one single, of which 1,000 copies have been sold so far, and a second pressing is in the process. The group is a combination rock band and vaudeville/cabaret performance. People would swarm onto the stage playing everything from cellos to violins, and doing other odd things that had little to do with music but were nevertheless entertaining. One night a fisherman stood on the stage angling for a dead bass in a bucket below. The end result of this piscatorial tour de force was a wet and fishy bunch of happy people.

Steve's next group was called The Rolling Stones. In case the name sounds familiar, we must explain that the group's objects were to write some new material, become a serious band--and, incidentally, get sued by the original Rolling Stones. Unfortunately, Mick Jagger and Keith Richards either didn't notice that their group's name had been copied, or noticed and didn't care.

No lawsuit, and no attending publicity ensued. The pseudo Stones can be seen, however, in the new Huey Lewis video "The Heart of Rock and Roll", as seen on MTV. The Stones are the strange looking band from New York at the beginning of the video that leaves Huey Lewis and his bandmates dumbstruck. Their last business offer was to do a soundtrack

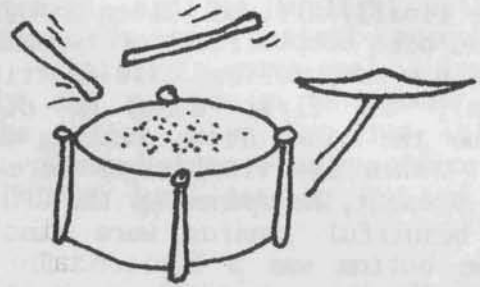

for a porno film. Unfortunately, the group disbanded.

Steve's latest band, Pianosaurus, plays toy instruments and has been playing a lot of clubs. Recent or upcoming appearances include CBGB's, Folk City, The Dive and Maxwell's. Jim Raydo, coauthor of "Hair", saw them at Folk City and liked their style. After passing an audition and making a recording, being paid all the while, they should soon appear in an Off-Broadway production.

If that doesn't work out? Or even if it does--Steve, a student at Jersey City State College, recently played the role of Romeo in a professionally videotaped performance of "Romeo and Juliet", which will be sold to cable TV--negotiations are currently in process with WHT and Manhattan Cable.

DISKETTE DISCOVERY

Do you ever get the urge to munch on a diskette? No? Well, you may before long! Authentic-looking 5 ¼ inch diskettes are now being made of chocolate, and, according to the editors of PC Week, who subjected the product to rigorous tests, they taste delicious.

To order a box of two four-ounce chocolate diskettes, just send \$12.95 to:

Sweetware, Inc.  
516 Shelburne Rd.  
So. Burlington, VT 05401

These diskettes are fit only for human consumption. If you feed them to your PC, serious internal disorders may ensue, such as chocolate on the electronic brain or softening of the I/O channels.



NORTH  
 ♠ 832  
 ♥ 32  
 ♦ A10976  
 ♣ AKJ

WEST  
 ♠ Q97  
 ♥ A864  
 ♦ KJ  
 ♣ 10732

EAST  
 ♠ 10  
 ♥ J1075  
 ♦ Q542  
 ♣ Q985

SOUTH  
 ♠ A K J 654  
 ♥ K Q 9  
 ♦ 83  
 ♣ 64

West	North	East	South
Pass	1♦	Pass	1♣
Pass	2♣	Pass	4♣
Pass	Pass	Pass	

## WHEN COMPUTERS PLAY BRIDGE

A little over twenty years ago a Columbia University math professor told his class that there aren't enough atoms in the universe to construct a computer capable of playing chess. Since that time, the atom population has not increased, but, due to rapid advances in technology, a number of pretty decent chess-playing computers have appeared on the market, some of them very cheap and many of them capable of beating all but expert human players.

The game of bridge, however, has not been so easy to program, dealing as it does with 52 cards dealt randomly into four hands bid and played by four players using a great variety of conventions and techniques and psychological crotchets.

According to Alan Truscott of The New York Times, "The work done so far has been described in 'Computer Bridge' by Thomas Throop, published by the Hayden Book Company."

When Throop pitted two rival bridge-playing machines against each other, the bidding was good, but the declarer's play and the defense were not so good. Both declarer and defense found some potentially winning plays, then lost their advantage by making some bad plays, and the eventual outcome was anyone's guess.

Are there enough atoms in the universe

to construct a computer capable of playing a really good game of bridge? There are probably more than enough--what we need is better software, especially for the home computer market. If any of you bridge-playing programmers and analysts out there can come up with a winning package, you'll probably make a pile of money!





### THE EXECUTIVE CRYSTAL BALL SPECULATIONS ON THE NEXT 15 YEARS

as told to Sandra Greer by  
JAY GOLDBERG

There will be plenty of business in 15 years, but it won't be the same business. Nearly all our present clients will be using the services of several very large companies to store, retrieve, and summarize data, and to generate reports. There are very few applications that cannot be incorporated in a package of some kind. As time goes on, businesses will find that it is to their advantage to change their procedures so as to be able to use packages for such functions as payroll, general ledger, accounts payable and receivable, etc. Even manufacturers will find that most of their system needs can be met by packages, and the availability of engineering aids and planning tools on microcomputers will expand to use live data.

On the desks of many users there will be terminals with libraries of software appropriate to the user's activity. The software available to users will be so easy to use that programmers will not be needed in most parts of the user organization. A data base manager will control security and solve any problems.

Behind the terminals will be immensely powerful machines, data-base machines tied to fast processors and advanced communication systems. Very large data bases will be stored. All the software needed for maintenance of the data, communications, and most applications will be provided by the data service. It will be something like the current trend in home banking, where the customer has access to a variety of canned software services for the price of account maintenance.

### WHAT DOES THIS MEAN TO THE FUTURE OF OUR BUSINESS?

There is, first of all, no abrupt change. Even when large data services are available, the job of converting current live systems to a standard system format will require teams of conversion programmers. There is also the possibility of creating a set of variable conversion packages and customizing them for use by clients. But this is a finite source of business activity.

The craft of programming will become more of an engineering discipline as we learn to use prefabricated parts (code generation packages) for efficiency and general correctness. Our services will be used by the new clients, the utilities, software vendors, and data services. The programs we write for these clients will be different from the ones we write for our present clients', being of the nonstop and fail-safe (fault-tolerant) variety. These clients will be very large companies, like our very largest clients now. Most intermediate-sized companies will not find custom software cost-effective.

Just as most people live in mass-produced housing, but some people will always build, there will be some custom software bought by end user companies. But the market

for this type of craft work will be relatively small.

The qualifications for a person working in our business will change gradually. The day of the "vanilla" COBOL programmer is about over. At some point only the maintenance of obsolete COBOL systems will be available. It is important for our people to become more technically proficient in expanding fields such as communications, databases, and microcomputers. Most of the work of an analyst will be in data analysis rather than in the development of procedures.

University training will become more relevant, as the industry incorporates such areas as robotics. It will still be important to have a good understanding of business, but it is likely that each individual will have an area of specialization (just as lawyers and accountants do), not just in the industry application but in a technical specialty such as local area networks. Because this kind of specialty changes rapidly, continuing education will become essential.

We may find ourselves offering services in engineering and related fields as our staff develop their special skills, the market changes, and new graduates show their skills are applicable in the current business environment.

#### IS THIS ALARMING?

Those of us who got into the field on the strength of our COBOL may find all this rather threatening. There are, of course, no guarantees about anyone's future. But we are not in the worst position. The worst case is that someone does not learn anything for the next 15 years. That would be boring but not fatal; such a person could specialize in maintaining old systems and holding

together some obsolete packages. These assignments are likely to be less frequent as time goes on, but there are always quite a few clients running old systems, as we all know. Even this person is in a better position than the client programmer whose old programs are being replaced by a set of packages provided by a time-sharing utility.

But most of us are indeed going to learn something every year. The important thing is to keep flexible and keep growing. Business is like biology: when the environment changes, living things (and businesses) move, change, or die. Humans are the most adaptable living things on earth. If we use our brains together, we will ride this wave of changing technology into the next century and have a lot of fun in the process.

#### NAME THE FUZZY CONTEST WINNER

The winner of the contest to name Gloria Beamon's warm fuzzy is Joe Thomas of the New York downtown branch, who submitted the following entry:

**S** **OFT** **D** **ELICATE** **A** **IRHEAD**

His prize will be an autographed color photo of Gloria and the fuzzy, who has started wearing tinted glasses to protect his (or her?) privacy.



IF YOU WANT TO SEE SOME OF THE FUNNY TIME SHEETS RECEIVED BY THE PHOENIX OFFICE ON BOB SEATE'S BIRTHDAY, JUST TURN THE PAGE!



# The SDA Newsletter

**WEEKLY TIME REPORT**

**SDA SERVICES**

TYPE ON USE WALL PAPER ONLY

NAME: Paula J.  
 EMPLOYEE NO: SOC07  
 BRANCH: SAGUARO CACTUS

CLIENT: BOB SEATE  
 DEPARTMENT: T.H. (TOO MUCH)

WEEK ENDING 03 | 20 | 84

MON.	TUES.	WED.	THURS.	FRI.	SAT.	SUN.	TOTAL	DEFINITION
------	-------	------	--------	------	------	------	-------	------------

IT'S TIME TO WISH YOU A HAPPY BIRTHDAY!!!!!!!!!!!!

Last week I spent my time:

1. Re-doing my time sheet
2. Drinking coffee with Ulysses
3. meditating
4. greeting Lache

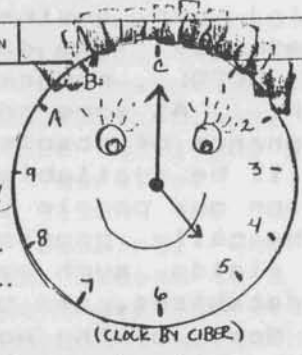

AND ALSO!!!!

- |                                       |  |   |
|---------------------------------------|--|---|
| <input type="radio"/> Parachutting    | <input checked="" type="radio"/> Gossiping     | <input checked="" type="radio"/> Shopping for a new spring wardrobe |
| <input type="radio"/> Sleeping it off | <input checked="" type="radio"/> Eavesdropping | <input type="radio"/> Shoplifting for a new spring wardrobe         |
| <input type="radio"/> Interviewing    | <input type="radio"/> Abending                 | <input type="radio"/> Doing Yoga                                    |
| <input type="radio"/> Playing bridge  | <input type="radio"/> Starting a new affair    | <input type="radio"/> Flowcharting the Rio Grande                   |

H	A	P	P	Y				TOTALLED	<u>Completely</u>
B	I	R	T	H	D	A	Y	Mental	<u>Lament</u>

EMPLOYEE SIGNATURE Paula

APPROVAL SIGNATURE 

CLIENT SIGNATURE X

**WEEKLY TIME REPORT**

**SDA SERVICES**

TYPE ON USE WALL PAPER ONLY

NAME: HEITH VOLK  
 EMPLOYEE NO: SOC07  
 BRANCH: SAGUARO CACTUS

CLIENT: BOB SEATE  
 DEPARTMENT: T.H. (TOO MUCH)

WEEK ENDING 03 | 20 | 84

MON.	TUES.	WED.	THURS.	FRI.	SAT.	SUN.	TOTAL	DEFINITION
------	-------	------	--------	------	------	------	-------	------------

IT'S TIME TO WISH YOU A HAPPY BIRTHDAY!!!!!!!!!!!!

Last week I spent my time:

1. FARTING IN THE BATHING.
2. INTERVIEWING WITH SOME...
3. PLANNING WITH MR. H.S. &...
4. WORKING WITH MY MENTAL DOCTOR...

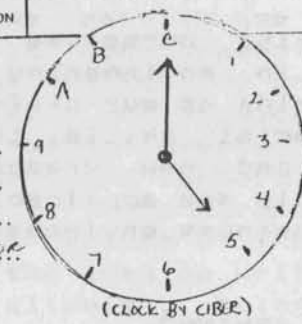

AND ALSO!!!!

- |                                       |   |   |
|---------------------------------------|---|---|
| <input type="radio"/> Parachutting    | <input type="radio"/> Gossiping             | <input type="radio"/> Shopping for a new spring wardrobe    |
| <input type="radio"/> Sleeping it off | <input type="radio"/> Eavesdropping         | <input type="radio"/> Shoplifting for a new spring wardrobe |
| <input type="radio"/> Interviewing    | <input type="radio"/> Abending              | <input type="radio"/> Doing Yoga                            |
| <input type="radio"/> Playing bridge  | <input type="radio"/> Starting a new affair | <input type="radio"/> Flowcharting the Rio Grande           |
- Wondering if my T.M. will ever visit A.P.S.

								TOTALLED	
								Mental	

EMPLOYEE SIGNATURE Heith Volk

APPROVAL SIGNATURE 

CLIENT SIGNATURE X

**WEEKLY TIME REPORT**

**SDA SERVICES**

TYPE OR USE BALL POINT PEN ONLY

NAME: STEVE FLETCHER  
 EMPLOYEE NO: S0007  
 BRANCH: SAGUARO CACTUS

CLIENT: BOB SEATE  
 DEPARTMENT: T.H. (TOO MUCH)

WEEK ENDING 03 | 20 | 84

MON.	TUES.	WED.	THURS.	FRI.	SAT.	SUN.	TOTAL	DEFINITION
------	-------	------	--------	------	------	------	-------	------------

IT'S TIME TO WISH YOU A HAPPY BIRTHDAY!!!!!!!!!!!!!!

- Last week I spent my time:
1. PLAYING GOLF
  2. QUITTING GOLF
  3. CATCHING UP ON THE SINGLES SCENE
  4. BEING GLAD I'M MARRIED

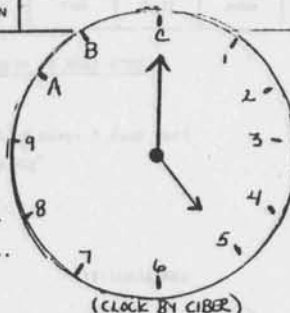

AND ALSO!!!!

- Parachutting
- Gossiping
- Shopping for a new spring wardrobe
- Sleeping it off
- Eavesdropping
- Shoplifting for a new spring wardrobe
- Interviewing
- Abending
- Doing Yoga
- Playing bridge
- Starting a new affair
- Flowcharting the Rio Grande

.001	.001	.001	.001	39.996			40	TOTAL
								Mental

EMPLOYEE SIGNATURE

*[Handwritten signature]*

APPROVAL SIGNATURE



CLIENT SIGNATURE



**WEEKLY TIME REPORT**

**SDA SERVICES**

TYPE OR USE BALL POINT PEN ONLY

NAME: Don J. Wright  
 EMPLOYEE NO: S0007  
 BRANCH: SAGUARO CACTUS

CLIENT: BOB SEATE  
 DEPARTMENT: T.H. (TOO MUCH)

WEEK ENDING 03 | 20 | 84

MON.	TUES.	WED.	THURS.	FRI.	SAT.	SUN.	TOTAL	DEFINITION
------	-------	------	--------	------	------	------	-------	------------

IT'S TIME TO WISH YOU A HAPPY BIRTHDAY!!!!!!!!!!!!!!

- Last week I spent my time:
1. Chasing Butterflies
  2. Tightening up Loose Women
  3. Dodging Snow birds
  4. Praying for Rain

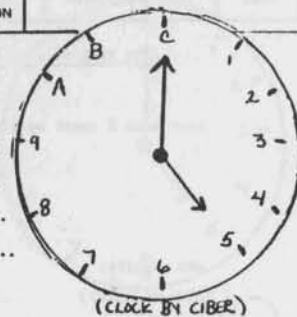

AND ALSO!!!!

- Parachutting
- Sleeping it off
- Shopping for a new spring wardrobe
- Interviewing
- Abending
- Doing Yoga
- Playing bridge
- Starting a new affair
- Flowcharting the Rio Grande

								TOTAL
9	9	9	8	8				Mental

EMPLOYEE SIGNATURE

*[Handwritten signature]*

APPROVAL SIGNATURE



CLIENT SIGNATURE



# The SDA Newsletter

## WEEKLY TIME REPORT

## SDA SERVICES

TYPE ON USE BALL POINT PEN ONLY

NAME: Vaughn McCullough  
EMPLOYEE NO: SOC07  
BRANCH: SAGUARO CACTUS

CLIENT: BOB SEATE  
DEPARTMENT: T.H. (TOO MUCH)

WEEK ENDING 03 | 328 | 84

MON.	TUES.	WED.	THURS.	FRI.	SAT.	SUN.	TOTAL	DEFINITION
------	-------	------	--------	------	------	------	-------	------------

IT'S TIME TO WISH YOU A HAPPY BIRTHDAY!!!!!!!!!!!!!!

Last week I spent X time: YOUR

1. STATUS REPORTS
2. CHERRY TIME SHOOT
3. ANALYZING THIS TIME SHOOT
4. FILLING OUT THIS TIME SHEET



AND ALSO!!!!

- |   |  |   |
|---|--|---|
| <input type="checkbox"/> Parachutting   | <input type="checkbox"/> Gossiping   | <input type="checkbox"/> Shopping for a new spring wardrobe   |
| <input checked="" type="checkbox"/> <del>Sleeping it off</del><br><u>HIDING IN THE MEN'S ROOM</u> | <input type="checkbox"/> Eavesdropping   | <input type="checkbox"/> Shoplifting for a new spring wardrobe  |
| <input checked="" type="checkbox"/> Interviewing<br><u>EXISTING SECRETARIES</u>                   | <input checked="" type="checkbox"/> <del>Abending</del><br><u>UNRESOLVING ABENDS</u> | <input checked="" type="checkbox"/> Doing Yoga<br><u>TEACHING</u>                                     |
| <input checked="" type="checkbox"/> Playing bridge<br><u>STRAY FORK</u>                           | <input checked="" type="checkbox"/> Starting / new affairs                           | <input checked="" type="checkbox"/> Flowcharting <u>the Rio Grande</u><br><u>FOR MY HOME COMPUTER</u> |

.980164	1.0001	.24513	.00001	.00001				TOTALLED
.12564	—	.855452	1.9843	2.51268				Mental

EMPLOYEE SIGNATURE YOU GOTTA BE KIDDING

APPROVAL SIGNATURE

CLIENT SIGNATURE

## WEEKLY TIME REPORT

## SDA SERVICES

TYPE ON USE BALL POINT PEN ONLY

NAME: Diana Mitchell  
EMPLOYEE NO: SOC07  
BRANCH: SAGUARO CACTUS

CLIENT: BOB SEATE  
DEPARTMENT: T.H. (TOO MUCH)

WEEK ENDING 03 | 20 | 84

MON.	TUES.	WED.	THURS.	FRI.	SAT.	SUN.	TOTAL	DEFINITION
------	-------	------	--------	------	------	------	-------	------------

IT'S TIME TO WISH YOU A HAPPY BIRTHDAY!!!!!!!!!!!!!!

Last week I spent my time:

1. TAKING 2 HOUR LUNCHES
2. COMING IN LATE / LEAVING EARLY
3. DOING MY TOENAILS DURING STAFF MEETINGS
4. READING WAR AND PEACE
5. CHARGED ALL OF LAST WEEKS TIME TO SDA (AS WELL AS OVERTIME / WAR AND PEACE IS A VERY LONG NOVEL!)

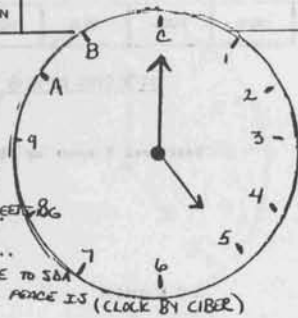

AND ALSO!!!!

- |  |  |  |
|--|--|--|
| <input type="checkbox"/> Parachutting    | <input type="checkbox"/> Gossiping     | <input type="checkbox"/> Shopping for a new spring wardrobe    |
| <input type="checkbox"/> Sleeping it off | <input type="checkbox"/> Eavesdropping | <input type="checkbox"/> Shoplifting for a new spring wardrobe |
| <input type="checkbox"/> Interviewing    | <input type="checkbox"/> Abending      | <input type="checkbox"/> Doing Yoga                            |
| <input type="checkbox"/> Playing bridge  | Starting a new affair                  | <input type="checkbox"/> Flowcharting the Rio Grande           |

								TOTALLED
								Mental

EMPLOYEE SIGNATURE

Diana Mitchell

APPROVAL SIGNATURE

CLIENT SIGNATURE

**WEEKLY TIME REPORT**

**SDA SERVICES**

TYPE OR USE BALL POINT PEN ONLY

NAME: Paul Resenthal CLIENT: BOB SEATE WEEK ENDING 03 | 20 | 84  
 EMPLOYEE NO: SOC07 DEPARTMENT: T.H. (TOO MUCH)  
 BRANCH: SAGUARO CACTUS

MON.	TUES.	WED.	THURS.	FRI.	SAT.	SUN.	TOTAL	DEFINITION
------	-------	------	--------	------	------	------	-------	------------

IT'S TIME TO WISH YOU A HAPPY BIRTHDAY!!!!!!!!!!!!!!

Last week I spent my time:

1. TEACHING BOB HOW TO RECRUIT STAFF
2. TEACHING BOB HOW TO SPELL FMS
3. SAYING "NO STAFF AVAILABLE TO CLIENTS"
4. SAYING "see Bob Seate" To STAFF

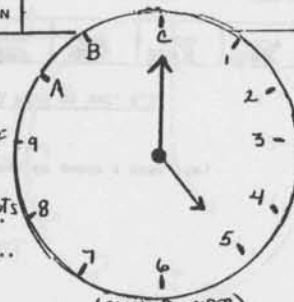

AND ALSO!!!!

- |   |   |   |
|---|---|---|
| <input checked="" type="checkbox"/> Parachutting    | <input checked="" type="checkbox"/> Gossiping     | <input checked="" type="checkbox"/> Shopping for a new spring wardrobe    |
| <input checked="" type="checkbox"/> Sleeping it off | <input checked="" type="checkbox"/> Eavesdropping | <input checked="" type="checkbox"/> Shoplifting for a new spring wardrobe |
| <input checked="" type="checkbox"/> Interviewing    | <input checked="" type="checkbox"/> Abending      | <input checked="" type="checkbox"/> Doing Yoga                            |
| <input checked="" type="checkbox"/> Playing bridge  | Starting a new affair                             | <input checked="" type="checkbox"/> Flowcharting the Rio Grande           |

							TOTALLED	
							Meat	

EMPLOYEE SIGNATURE: Paul Resenthal APPROVAL SIGNATURE: CLIENT SIGNATURE: X

**WEEKLY TIME REPORT**

**SDA SERVICES**

TYPE OR USE BALL POINT PEN ONLY

NAME: N. GENIBERRY CLIENT: BOB SEATE WEEK ENDING 03 | 20 | 84  
 EMPLOYEE NO: SOC07 DEPARTMENT: T.H. (TOO MUCH)  
 BRANCH: SAGUARO CACTUS

MON.	TUES.	WED.	THURS.	FRI.	SAT.	SUN.	TOTAL	DEFINITION
------	-------	------	--------	------	------	------	-------	------------

IT'S TIME TO WISH YOU A HAPPY BIRTHDAY!!!!!!!!!!!!!!

Last week I spent my time:

1. Having a nervous breakdown...
2. Hosting Crowell's birthday party.
3. Destroying SDA's tank files.....
4. Asking for bail money.....

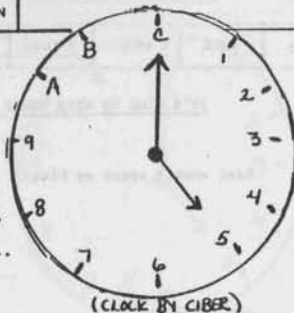

AND ALSO!!!!

- |   |  |  |
|---|--|--|
| <input type="checkbox"/> Parachutting               | <input type="checkbox"/> Gossiping     | <input checked="" type="checkbox"/> Shopping for a new spring wardrobe |
| <input checked="" type="checkbox"/> Sleeping it off | <input type="checkbox"/> Eavesdropping | <input type="checkbox"/> Shoplifting for a new spring wardrobe         |
| <input type="checkbox"/> Interviewing               | <input type="checkbox"/> Abending      | <input type="checkbox"/> Doing Yoga                                    |
| <input type="checkbox"/> Playing bridge             | Starting a new affair                  | <input type="checkbox"/> Flowcharting the Rio Grande                   |

							TOTALLED	
							0	
							-5	Meat

EMPLOYEE SIGNATURE: From Bob - With love, N. Geniberry APPROVAL SIGNATURE: CLIENT SIGNATURE: X

# The SDA Newsletter

**WEEKLY TIME REPORT**

**SDA SERVICES**

TYPE ON USE WALL POINT FOR ONLY

NAME: MISS ANN  
 EMPLOYEE NO: SOCO7  
 BRANCH: SAGUARO CACTUS

CLIENT: BOB SKATE  
 DEPARTMENT: T.H. (TOO MUCH)

WEEK ENDING 03 | 20 | 84

MON	TUES	WED	THURS	FRI	SAT	SUN	TOTAL	DEFINITION
-----	------	-----	-------	-----	-----	-----	-------	------------

IT'S TIME TO WISH YOU A HAPPY BIRTHDAY!!!!!!!!!!!!

Last week I spent my time:

1. MONDAY - 2 HOURS LATE (2)
2. MON - THURS - 3 HOURS LUNCA (10)
3. WEDNESDAY - 1 HOUR (11)
4. FRIDAY - TOOK DAY OFF (12)

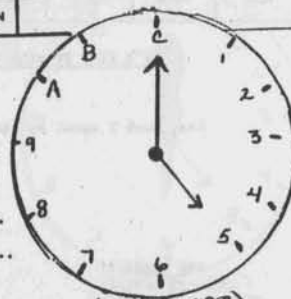

AND ALSO!!!!

- |                   |  |   |
|-------------------|--|---|
| 1 Parachutting    | 5 Gossiping                            | 9 Shopping for a new spring wardrobe      |
| 2 Sleeping it off | 6 Eavesdropping                        | 10 Shoplifting for a new spring wardrobe  |
| 3 Interviewing    | 7 Abending                             | 11 Doing Yoga                             |
| 4 Playing bridge  | 8 Starting a new affair                | 12 Flowcharting the Rio Grande            |
| 4A MANICURE NAILS | 8A OVERWOKED NEEDED A REAL DAY TO REST | 12A LOOKING FOR DECENT PLACE TO EAT LUNCA |

								TOTALLED	<u>0003 0030</u>
								Metric	

EMPLOYEE SIGNATURE Louie

APPROVAL SIGNATURE

CLIENT SIGNATURE X

**WEEKLY TIME REPORT**

**SDA SERVICES**

TYPE ON USE WALL POINT FOR ONLY

NAME: J.C.  
 EMPLOYEE NO: SOCO7  
 BRANCH: SAGUARO CACTUS

CLIENT: BOB SKATE  
 DEPARTMENT: T.H. (TOO MUCH)

WEEK ENDING 03 | 20 | 84

MON	TUES	WED	THURS	FRI	SAT	SUN	TOTAL	DEFINITION
-----	------	-----	-------	-----	-----	-----	-------	------------

IT'S TIME TO WISH YOU A HAPPY BIRTHDAY!!!!!!!!!!!!

Last week I spent my time:

1. RUNNING AROUND FOR WINDBLE
2. KEEPING THIS A SECRET
3. DRINKING
4. ....

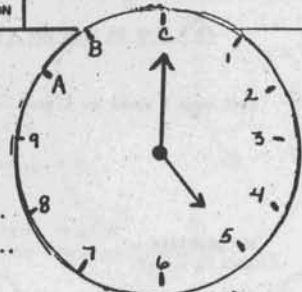

(THEY DENY NICE CLOCKS, BUT CAN THEY CODE)

AND ALSO!!!!

- |                 |                       |                                       |
|-----------------|-----------------------|---------------------------------------|
| Parachutting    | Gossiping             | Shopping for a new spring wardrobe    |
| Sleeping it off | Eavesdropping         | Shoplifting for a new spring wardrobe |
| Interviewing    | Abending              | Doing Yoga                            |
| Playing bridge  | Starting a new affair | Flowcharting the Rio Grande           |

<u>1.333</u>	<u>3333</u>	<u>3333</u>	<u>3333</u>	<u>5555</u>	<u>3333</u>	<u>5333</u>	<u>3333</u>	TOTALLED	<u>WIPED OUT / OVERFLOWED / GIVE ME</u>
								Metric	<u>A</u>

EMPLOYEE SIGNATURE gc

APPROVAL SIGNATURE

CLIENT SIGNATURE X



**WEEKLY TIME REPORT**

**SDA SERVICES**

NAME: JERRY BURNETT  
 EMPLOYEE NO: SDCO7  
 BRANCH: SAGUARO CACTUS

CLIENT: BOB SKATE  
 DEPARTMENT: T.H. (TOO MUCH)

WEEK ENDING 03 | 20 | 84

MON	TUES	WED	THURS	FRI	SAT	SUN	TOTAL	DEFINITION
-----	------	-----	-------	-----	-----	-----	-------	------------

IT'S TIME TO WISH YOU A HAPPY BIRTHDAY!!!!!!!!!!!!

Last week I spent my time:

1. DESIGNING INITIAL MAPS FOR TAFE.....
2. CONVERTING ONLINE TO BIRTH CARDS.....
3. DIVIDING BY ZERO.....
4. LYING TO SREH. SYSTEMS ANALYST.

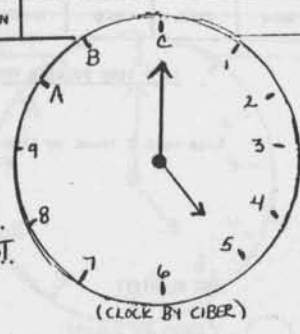

AND ALSO!!!!

- Parachutting
- Sleeping it off
- Interviewing
- Playing bridge
- Gossiping
- Eavesdropping
- Abending
- Starting a new affair
- Shopping for a new spring wardrobe
- Shoplifting for a new spring wardrobe
- Doing Yoga
- Flowcharting the Rio Grande

4	0	4	0	4	0	4	169	TOTAL LFD
	8		8		8		8	Mental

EMPLOYEE SIGNATURE: [Signature]

APPROVAL SIGNATURE: [Signature]

CLIENT SIGNATURE: [Signature]

**WEEKLY TIME REPORT**

**SDA SERVICES**

TYPE OR USE BALL POINT PEN ONLY

NAME: LARRY ERIN  
 EMPLOYEE NO: SDCO7  
 BRANCH: SAGUARO CACTUS

CLIENT: BOB SKATE  
 DEPARTMENT: T.H. (TOO MUCH)

WEEK ENDING 03 | 20 | 84

MON	TUES	WED	THURS	FRI	SAT	SUN	TOTAL	DEFINITION
-----	------	-----	-------	-----	-----	-----	-------	------------

IT'S TIME TO WISH YOU A HAPPY BIRTHDAY!!!!!!!!!!!!

Last week I spent my time:

1. Hiding out.....
2. FAULTING.....
- 3.....
- 4.....



AND ALSO!!!!

- Parachutting
- Sleeping it off
- Interviewing
- Playing bridge
- Gossiping
- Eavesdropping
- Abending
- Starting a new affair
- Shopping for a new spring wardrobe
- Shoplifting for a new spring wardrobe
- Doing Yoga
- Flowcharting the Rio Grande

								TOTAL LFD
								Mental

EMPLOYEE SIGNATURE: \_\_\_\_\_

APPROVAL SIGNATURE: [Signature]

CLIENT SIGNATURE: [Signature]

# The SDA Newsletter

## WEEKLY TIME REPORT

## SDA SERVICES

TYPE OR USE BALL POINT PEN ONLY

NAME: Wynelle Plattner  
 EMPLOYEE NO: S0C07  
 BRANCH: SAGUARO CACTUS

CLIENT: BOB SEATR  
 DEPARTMENT: T.H. (TOO MUCH)

WEEK ENDING 03 | 20 | 84

MON.	TUES.	WED.	THURS.	FRI.	SAT.	SUN.	TOTAL	DEFINITION
------	-------	------	--------	------	------	------	-------	------------

IT'S TIME TO WISH YOU A HAPPY BIRTHDAY!!!!!!!!!!!!!!

Last week I spent my time:

1. Planning your party
2. Buying errands for your party
3. Spending \$ for your party
4. Fighting fatigue

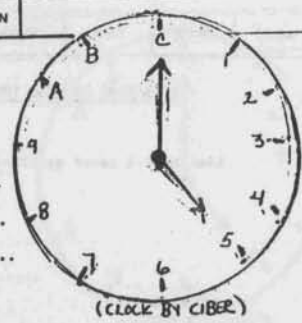

AND ALSO!!!!

- |  |   |  |
|--|---|--|
| <input type="checkbox"/> Parachutting    | <input checked="" type="checkbox"/> Gossiping     | <input checked="" type="checkbox"/> <u>Wishing</u><br>Shopping for a new spring wardrobe |
| <input type="checkbox"/> Sleeping it off | <input checked="" type="checkbox"/> Eavesdropping | <input type="checkbox"/> Shoplifting for a new spring wardrobe                           |
| <input type="checkbox"/> Interviewing    | <input type="checkbox"/> Abending                 | <input type="checkbox"/> Doing Yoga mentally   |
| <input type="checkbox"/> Playing bridge  | <input type="checkbox"/> Starting a new affair    | <input type="checkbox"/> Flowcharting the Rio Grande                                     |

H	A	P	P	Y	!	!	!	TOTALLED	
B	I	R	T	H	D	A	Y	Mental	

EMPLOYEE SIGNATURE WUP

APPROVAL SIGNATURE 

CLIENT SIGNATURE X

## WEEKLY TIME REPORT

## SDA SERVICES

TYPE OR USE BALL POINT PEN ONLY

NAME: Ray Keilman  
 EMPLOYEE NO: S0C07  
 BRANCH: SAGUARO CACTUS

CLIENT: BOB SEATR  
 DEPARTMENT: T.H. (TOO MUCH)

WEEK ENDING 03 | 20 | 84

MON.	TUES.	WED.	THURS.	FRI.	SAT.	SUN.	TOTAL	DEFINITION
------	-------	------	--------	------	------	------	-------	------------

IT'S TIME TO WISH YOU A HAPPY BIRTHDAY!!!!!!!!!!!!!!

Last week I spent my time:

- Trying to get a job at Ramada  
Trying to get a job at Anchorage  
Trying to get a job with the state  
Deciding I couldn't leave SDA  
(nobody else wanted me)

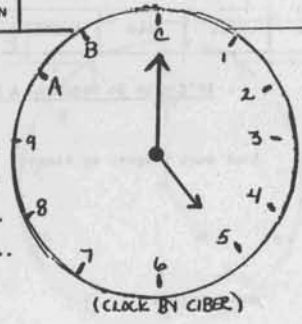

AND ALSO!!!!

- |  |  |  |
|--|--|--|
| <input type="checkbox"/> Parachutting                          | <input type="checkbox"/> Gossiping             | <input type="checkbox"/> Shopping for a new spring wardrobe    |
| <input checked="" type="checkbox"/> <del>Sleeping it off</del> | <input type="checkbox"/> Eavesdropping         | <input type="checkbox"/> Shoplifting for a new spring wardrobe |
| <input type="checkbox"/> Interviewing                          | <input type="checkbox"/> Abending              | <input type="checkbox"/> Doing Yoga                            |
| <input type="checkbox"/> Playing bridge                        | <input type="checkbox"/> Starting a new affair | <input type="checkbox"/> Flowcharting the Rio Grande           |

								TOTALLED	<u>CONSTANTLY</u>
								Mental	<u>NONE</u>

EMPLOYEE SIGNATURE Raymond M Keilman

APPROVAL SIGNATURE 

CLIENT SIGNATURE X

**WEEKLY TIME REPORT**

**SDA SERVICES**

TYPE ON USE WALL POSITION ONLY

NAME: Buddy Harrison  
 EMPLOYEE NO: SOC07  
 BRANCH: SAGUARO CACTUS

CLIENT: BOB SEATE  
 DEPARTMENT: T.H. (TOO MUCH)

WEEK ENDING 03 | 20 | 84

MON.	TUES.	WED.	THURS.	FRI.	SAT.	SUN.	TOTAL	DEFINITION
------	-------	------	--------	------	------	------	-------	------------

IT'S TIME TO WISH YOU A HAPPY BIRTHDAY!!!!!!!!!!!!

Last week I spent my time:

- 1... FRUSTRATION .....
- 2... FUTILITY .....
- 3... DEVELOPING PATIENCE .....
- 4... CONTEMPLATING SUICIDE .....

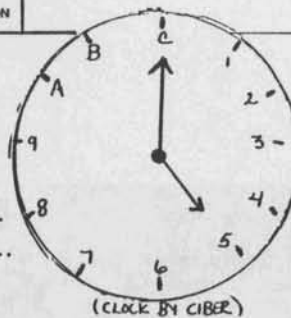

AND ALSO!!!!

- |   |  |   |
|---|--|---|
| <input type="checkbox"/> Parachutting               | <input type="checkbox"/> Gossiping             | <input type="checkbox"/> Shopping for a new spring wardrobe     |
| <input checked="" type="checkbox"/> Sleeping it off | <input type="checkbox"/> Eavesdropping         | <input type="checkbox"/> Shoplifting for a new spring wardrobe  |
| <input type="checkbox"/> Interviewing               | <input checked="" type="checkbox"/> Abending   | <input type="checkbox"/> Doing Yoga                             |
| <input type="checkbox"/> Playing bridge             | <input type="checkbox"/> Starting a new affair | <input checked="" type="checkbox"/> Flowcharting the Rio Grande |

8 hr	9 hr	10 hr	8 hr	9 hr	8 1/2 hr			TOTALLED
8 hrs	9 hr	10 hrs	8 hrs	9 hr	8 1/2 hr			Mental

EMPLOYEE SIGNATURE

*Buddy Harrison*

APPROVAL SIGNATURE



CLIENT SIGNATURE

X

**WEEKLY TIME REPORT**

**SDA SERVICES**

TYPE ON USE WALL POSITION ONLY

NAME: LARRAL PARAL  
 EMPLOYEE NO: SOC07  
 BRANCH: SAGUARO CACTUS

CLIENT: BOB SEATE  
 DEPARTMENT: T.H. (TOO MUCH)

WEEK ENDING 03 | 20 | 84

MON.	TUES.	WED.	THURS.	FRI.	SAT.	SUN.	TOTAL	DEFINITION
------	-------	------	--------	------	------	------	-------	------------

IT'S TIME TO WISH YOU A HAPPY BIRTHDAY!!!!!!!!!!!!

Last week I spent my time:

- 1... LOOKING FOR SECRETARIES IN THE U.S. BUILDINGS .....
- 2... TAKING LUNCH LUNCHE .....
- 3... DRIVING MY CAR IN THE AFTERNOON .....
- 4... LEAVING WORK EARLY BECAUSE I CAME IN LATE .....

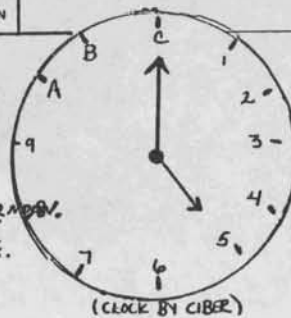

AND ALSO!!!!

- |   |   |   |
|---|---|---|
| <input type="checkbox"/> Parachutting               | <input checked="" type="checkbox"/> Gossiping             | <input checked="" type="checkbox"/> Shopping for a new spring wardrobe    |
| <input checked="" type="checkbox"/> Sleeping it off | <input type="checkbox"/> Eavesdropping                    | <input checked="" type="checkbox"/> Shoplifting for a new spring wardrobe |
| <input checked="" type="checkbox"/> Interviewing    | <input type="checkbox"/> Abending                         | <input type="checkbox"/> Doing Yoga                                       |
| <input type="checkbox"/> Playing bridge             | <input checked="" type="checkbox"/> Starting a new affair | <input type="checkbox"/> Flowcharting the Rio Grande                      |

.2	.3761	2.483	.18654	1/2	.606			TOTALLED
								Mental
								5

EMPLOYEE SIGNATURE

*Larral Parale*

APPROVAL SIGNATURE



CLIENT SIGNATURE

X

TOBI &  
SETH  
HANOVER



PAUL &  
LIBBE  
ROSENTHAL



LARRY  
JUDY  
NOREEN  
LAURA  
OTIS  
PAULINE



TOM  
ELAINE  
RANDY &  
JOY  
CHRIS  
&  
JOHN  
RAY  
EVELYN



BILL  
ANNE

JOEL  
DAN & KIM

KEITH  
DIANE



JOHN  
WYNELLE

STEVE  
IRENE

GREG  
DIANNE



BOB & PAULINE SEATE

JOY & GEORGE LEACH

BUDDY & DEBBIE HARRISON

CYNDI CONNOLLY



# NEWS FROM NORTON



## MAG-PIES

After much BS&T (No gang, that's not a sandwich), the results of the MAG elections are in. Many people ran for or were chased into the different representative positions. Each and all well deserving of the honor. May I have the envelope, please? (Drum roll) And the winners are:

TECH STAFF: John Klein  
Susan Schnur  
Mike Carlo  
Mike Barr  
Mike Innes  
Wanda Probst (alternate)

ACCT SUPV: Tom Baer

ACCT EXEC: Amanda Cannon

TECH MGR: Lori Yee \*

BRANCH MGR: Stan Detwiler \*

\* unanimous

Congratulations to all, and good luck during the coming year.

## CAR 54, WHERE ARE YOU

It was definitely a case for Toody and Muldoon. The date: January 13th. The time: 5:00 p.m. The occasion: check night, er Un-check night. It was a night when everyone, even Richard Kosheff, showed up. Unfortunately they all left the way they came, broke. Several phone calls between Stan Detwiler and the New York office tracked down the checks to an Emery van somewhere in North America.

The checks were finally located the following day at the Every warehouse on the other side of Norwalk. The Bear

retrieved them, and stayed at the office so people could pick them up.

## "...SMELLING LIKE A ROSE"

Cheryl Leveen has been using a bus and train combination to commute to her latest assignment. One evening, while waiting at the bus stop to begin her journey home, she realized she had left her purse in her desk. She returned to her office building, knowing she would miss her bus, and explained her plight to the guard so she could retrieve her purse. A hired limousine service chauffeur who had just dropped off his passengers overheard her, and, when she returned to the lobby with her purse, offered Cheryl a ride. Cheryl's train traveling companions still haven't gotten over the shock of seeing her arrive in front of the station in a chauffeured limousine. See what good, clean living will do for you?

Ruben Rodriguez, at another client site, was getting a bit nervous preparing for his first "walk-thru" of his contributions to a system. Veteran SDAer's at the client, as well as client staffers, were hard pressed to calm him down; they reassured him that the whole thing was merely a formality, presided over by a carefully chosen "friendly" user. The day of the meeting finally arrives and so does Ruben, calm and collected. Unfortunately, also arriving were all kinds of senior managers, executives, and senior executives. Seems Ruben's work touched upon a wide variety of areas, and everyone was interested. To his own surprise and credit Ruben handled the meeting well, and gained the respect of all attending.

## ON THE ROAD AGAIN

Kathy Hushion went skiing with friends one very cold weekend in January. On the way up to Vermont, their car accidentally met up with a snowbank. They finally arrived at their destination, but they only put in one day of skiing. Wonder what they did the rest of the weekend.

Ken Davis enjoyed 10 days in St. Croix, not St. Thomas as we originally reported. At least he kept it religious.

Donn Morrill is away (again!), this time to Guadeloupe. If he opens up an account there, yours truly has first dibs.

The East Coast and the West Coast Dianes, (Theurer and Mitchell) met in Miami where they embarked on a cruise through the Caribbean aboard the MS Starward. Our Diane returned, not TOO sunburned and not TOO hungover, but she said she had a great time anyway.

### BITS, BYTES, AND PIECES

Angela Salt and Lucy Price both got new cars recently: a Skylark and a Jeep, respectively. They both just happen to be working at a bank. HMMMM!!

Of the five prizes in Tom Baer's Superbowl Pool, one went to his Account Executive, one to a friend of his, one to his sister, and one to him. HMMMM!!

Marianne Seggerman recently met a blind date at The Lighthouse in Norwalk, a favored waterhole. Standing around the corner from the two of them was a group of SDAer's; Stan, Amanda, Lori, Diane, and the Bear. Marianne didn't seem to mind their presence until they started holding up cards with scores on them.

Bill McLachlan recently closed on his new house.

If anyone has noticed Ruben Rodriguez looking a bit more muscular lately, it's because he is debuting in a new sideline: modeling. He and his wife were chosen to model a collection of wedding outfits for a bridal fashion show in Newtown.

### OOPS

Can't forget to mention our new staff member, Linda Shelinsky. She will be assisting Robyn in the office as well as taking on the job of recruiting new technical staff members. Best of luck to you.

### Safety Tip of The Month

The simplest way to cure stubborn hiccups is to massage the roof of the mouth near the throat with a cotton-

tipped swab, the Journal of the American Medical Association reports. The technique has been almost 100 percent successful in test patients. It takes only a minute to massage the center of the soft palate just beyond the point where it joins the hard palate, claims Dr. Steven Goldsmith of Baystate Medical Center in Springfield, Mass. (If that doesn't work, hold your breath for twenty minutes.)

### SCHOOL DAZE

Once again, the SDA offices have become towers of knowledge and lore. On Tuesday nights each week, several enthusiastic students listen attentively as Pauline Yuen takes them on a wondrous journey through the land of PL/1. Up in the northern reaches of Hartford, Lucy Price (with a little help from CNB) is tutoring her charges on the wise and wicked ways of IDMS. As soon as a wizard powerful enough to exorcise the spirit "Stan" from the PC can be found, there will be a class on its use. Finally, the four winds bring tales of an IMS course to come riding on a bear being led by a fair maiden.

### "IT" MAKES THE WORLD GO ROUND

Donn Morrill has been working on improving client relationships. "A happy client means bigger cars, bigger boats!" Proof of his success came recently when he was delivering Marianne Seggerman to a new assignment, and one of the female project managers raced down the hall to greet him with a hug and a big kiss. Keep up the good work, Donn!

Which popular, recently retired playboy among our staff left a tell-tale article of clothing at the house of an attractive single female staff member? And how does he plan to get it back before his wife notices?

Pirjio Westman's husband Peter flew in from Sweden last week to finally spend some time with his bride. The newlyweds will be living in Springdale.

Rumors have been spreading lately about Mike Barr's taste in women. Some even have him romancing Betsy Baker's

daughter, Katie. More on this next month!

### SLOPE DOPE

Now that Spring is only a week away, the skiing conditions in Vermont have been excellent. Marianne Seggerman spent a recent weekend at Sugarbush. John Sibley spent some time at Butternut teaching young James how to get around on skis. Diane Theurer enjoyed a weekend at Mt. Snow and drove back in a blizzard; the car only left the road once on the way home. Amanda Cannon skied at Magic Mountain and other mountains in southern Vermont. Stan Detwiler has also skied quite a bit in southern Vermont, making the trip almost every weekend. On his most recent trip, he suffered an injury to his hand. When he returned to work, Donn and Amanda kidnapped him and took him to the hospital. We don't know if it was for X-rays or to have him committed. In any case, his thumb was only sprained and he is still able to use the PC in the office.

### MAG-PIES

On February 27th, Tom Baer attended the first Company-wide MAG meeting, held at the New York office. The meeting was considered productive, with no big surprises. Tom's motion to have the next meeting in Honolulu was shot down on the technicality that we don't have a branch there (yet!). The report on the meeting is being distributed with the checks tonight.

The MAG, courtesy of Mike Carlo, finally has a rough draft of an Attendance Incentive Plan. This draft will be a major issue on the next agenda, so if you're curious, plan on attending the next meeting - Wednesday, March 28th at 5:30 p.m. The MAG meetings are always open to all staff members.

### OFFICE FACELIFT

If you haven't noticed, the office has a new coat of paint. Stan, however, wanted his corner to have a special look, so he came in to the office in his wallpapering uniform (jeans and a sweatshirt). Check out his plaid walls. Stan is available for wallpapering jobs from 9-5 Monday

through Friday.

### PC PATTERN

Since the IBM/PC was set up in the Norwalk office, Mike Grabel has been down to lend his expertise in setting up menus and programs to handle all sorts of things. Mike's time and talent were definitely appreciated in this effort. We have been looking desperately for someone to perform a Stanectomy on the machine, though. If you've called Stan lately and he sounded a bit ornery, you've probably disturbed him from his place at the terminal. Hopefully he will tear himself away for a few hours each week to allow for a training course on the use of the machine. Look for an article on "COBOL Compile and LINK BATCH on the IBM PC" by Mike Grabel in the corporate (quarterly) SDA newsletter.

### BITS, BYTES, AND PIECES

- o Word has it that Patty Lamb has discovered a new cure for hangovers: basket weaving!
- o We also have it on good authority that when Patty works, her concentration is total. Once while she was working, she didn't even notice she was being boxed into her cubicle by a printer. When she finally did notice, it took an emergency request to Floor Planning management to get her out.
- o Carl and Pam VanWinter celebrated their second wedding anniversary recently. Pam got the flu; I wonder what Carl got.
- o Wanda and Gus Probst, Mark Fichman, Cheryl Leveen, Diane Theurer, John Palitz, and Tom Baer all met for a Happy Hour one Friday night in White Plains. Later, the crew went to the Marriot in Tarrytown, losing John to his family and Mark to a friendly blonde along the way.

### SAFETY TIPS OF THE MONTH

Beware the "ice" of March!

REMEMBER THE SDA REFERRAL PROGRAM



TITLE: COBOL COMPILE AND LINK BATCH ON THE IBM PC.

AUTHOR: MIKE GRABEL, SDA, X2244

DATE: FEBRUARY 27, 1984

AS WAS MENTIONED IN A PREVIOUS ISSUE OF BIT PIC'N, CML HAS THE mbp COBOL COMPILER FOR THE IBM PC. THIS IS ANS COBOL 74 LEVEL 2, WHICH MEANS THAT WHILE IT MAY NOT RUN UNDER "XA" IT'S STILL THAT SAME OLD COBOL WE ALL KNOW AND LOVE.

THE COMPILER IS INVOKED BY TYPING COBOL FOLLOWED BY THE PROGRAM NAME:

COBOL SIEVE.COB

THE PROGRAM WILL THEN BE COMPILED WITH THE DEFAULT PARAMETERS.

HOWEVER, IF YOU NEED TO SPECIFY OTHER PARAMETERS SUCH AS A WORK FILE SIZE OF 250K TO COMPILE WITHOUT A HARD DISK, OR FOR INTERACTIVE DEBUG YOU ARE REQUIRED TO ENTER INTO A DIALOG WITH THE COMPILER AFTER ENTERING ONLY THE WORD COBOL.

THOSE OF US USED TO SUBMITTING COMPILE AND LINK JOBS FROM TSO CLISTS MAY PREFER SOMETHING A LITTLE SHORTER. THERE IS A WAY USING DOS 2.0 REDIRECTED INPUT.

EXAMPLE 1. SHOWS A BATCH FILE, COMPINK.

BAT WHICH COMPILES AND LINKS THE SPECIFIED PROGRAM WITH DEFAULT PARAMETERS.

EXAMPLE 1. COMPINK.BAT

```
ECHO OFF
BREAK ON
COBOL %1.COB
LINK %1,,MBPCOBOL
```

THE %1 IS REPLACED BY THE FILE NAME ENTERED AFTER THE BATCH NAME i.e. complnk sieve WOULD COMPILE AND LINK SIEVE.COB.

EXAMPLE 2. SHOWS A BATCH FILE, COBINK.BAT WHICH COMPILES AND LINKS THE SPECIFIED PROGRAM WITH PARAMETERS FROM A TEMPORARY FILE.

EXAMPLE 3. SHOWS THE BATCH FILE, PARMLNK.BAT WHICH CREATES THE PARAMETER FILE AND INVOKES COBINK.BAT.



YOU MUST HAVE BEEN A BEAUTIFUL BABY  
YOU MUST HAVE BEEN A WONDERFUL CHILD

Can you identify the SDA employees whose pictures appear above and below? Their names are revealed in the puzzle section.



SEEN ON A TAKE-OUT MENU

ROAST PORT OR ROAST BEEF WITH GRAVY 3.75

Ah, those liquid lunches!

DIAPER DATA

Jim Fastiggi and his wife Linda are the proud parents of a new baby girl.

UNION NEWS

Jim Ferrara was married this past Saturday in a small local parish church on 5th Avenue between 50th and 51st Streets in Manhattan called St. Patrick's. He and his bride Christina are honeymooning in the Bahamas.

JOCK SCRAPS

This season's first softball practice was held on Thursday, April 26th, at Veteran's Park in Norwalk. A hearty crew of Paul Reitz, John Klein, Janet Haviland, Marianne Seggerman, Diane Theurer, Mats Borgelid, John Sibley, and Tom Baer were lead through a rigorous session by Captain Mike Barr. Our hitting looks good: the Bear seems to have shaken off his two-year slump, and Mats (who never held a bat before) and Diane) who never knew what to do with one) were getting a lot of good solid shots. John K. and Mike both handled pitching chores, indicating a strong bullpen to help take the pressure off our star pitcher, Lori Yee. The whole team, however, needs a lot more practice "playing the field".

## Upcoming dates:

Thursday, May 3rd vs. Pepsico  
Wednesday, May 16th - practice  
Friday, June 1st vs. County of Westchester

BE THERE!

Bill McLachlan attended opening day at Yankee Stadium, just to make sure he got a Yankee cap for his son, Bill, Jr.

Stan Detwiler is taking scuba diving lessons, so he, Amanda, and Donn can all sink together.

MAG-PIES

Congratulations to Mike Barr, newly-elected chairman of the 1984 MAG, and thanks to all the outgoing members for a great job.

KUDOS

Amanda Cannon has been hard at work lately, writing proposals for project work at client sites. These proposals would require staffing entire projects, from the project leader to the least programmer with SDA people, giving our staff opportunities to expand our technical experiences and hone our administrative skills. Putting such a proposal together involves a great deal of thought, cunning, and plain old hard work. There is also a lot of typing involved, so much so that Linda and Robyn are considering foregoing their salaries if they can get paid by the word.

The competition in this form of job-bidding is very tough, and having a client accept one's proposal is a great tribute. Amanda's batting average is .500 so far, succeeding in one proposal whose scope she still hasn't been able to fathom (It may be world-wide!). Congratulations, Amanda; keep up the good work. We're all proud of you.

Attached to this month's newsletter are copies of a flier describing a new software product produced by one of our clients. This product, of which the client is very proud, has been designed and implemented by our own resident genius, Jim Reid. Jim's work and abilities are well-known and well-respected throughout SDA, and once again, he's done us proud.

We editors of News From Norton would like to thank all of you who have been contributing articles. The newsletter would be only this big:

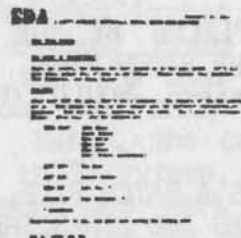

if it weren't for you! We would especially like to thank Betsy Baker for hosting a few news-gathering dinners, for which she has cooked a wide assortment of delicious dishes, including a roast turkey. Thanks again to all of you, and

keep those articles coming!

### REFLECTIONS OF A SPRING PARTY

"Where's the beef?!?".....Early arrivals waiting in the lobby for someone to take charge....."Where's the bar?!?".....Janet Haviland's super outfit.....John Stopper and Seth Hanover talking shop....."Waddaya mean, I can have beer or wine, but no soda?!?".....Ed Yee setting up his studio while Lori shanghai's models..... Nancy Wilson telling horror stories to Cheryl Leveen....."Where IS John Klein ticklish?!?".....Mats Borgelid and Pirjio Westman brushing up on their Swedish....."Kinda short variety on the food, huh!".....Mike Barr and the Bear break out the guitars while Marianne Seggerman breaks out her needlepoint.....Mike breaks his first string.....Bob Steinberg singing harmony on the do-wops.....Mike breaks his second string....."We're going out for some real booze!".....Robyn Boccardi and Linda Shelinsky leaving to watch educational films on Linda's VCR.....The Bear's 'Maleguena'.....Party breaking up.....Wild race to Bunyan's.....Carl VanWinter, Paul Reitz, and Steve Manzier judging the Miss Teenage America Pageant.....Stan Detwiler and Betsy Baker's 'serious discussion', which ended when Cheryl tackled Stan.....Diane Theurer and Mark Fichman making enough popcorn to strip Nebraska.....Breakfast at the Silver Star....."When's the picnic?!?"

### YOUNG MEN'S FANCIES

On National Secretary's Day, Stan Detwiler brought in flowers for both Robyn Boccardi and Linda Shelinsky. He also offered to take them to lunch at the restaurant of their choice, hoping they would pick the hot-dog stand on the corner. They opted for Garbo's in Greenwich instead, and upon arriving, found the restaurant was having a showing of intimate apparel. The luncheon conversation covered such topics as the various applications one can make with make-up, basic human anatomy, and "snaps" (as used in trap doors). During dessert, Amanda Cannon was very interested in Linda's warm cherries. We're sure Stan wasn't sorry he missed the hot-dogs.

### BITS, BYTES, AND PIECES

Ken Davis' picture appeared in the Stamford Advocate showing him enjoying lunch al fresco. And he told us he was too busy to eat that day!

John Stopper got a new house and a new Audi. His wife is allowed in the house.

Donn Morrill's wife Chris sent him a dozen yellow roses for his 40th birthday.

While staying at her mother's house, Kathy Hushion was awakened one morning by a policeman inquiring about a motorcycle parked in the driveway. It seems the owner had been tearing up the neighbors' lawns riding it. Everyone at Kathy's mother's denied ever having been on a bike. Afterwards, Kathy put on her official Hell's Angels jacket and rode home.

Carl and Pam VanWinter's 5-month-old son, Scott, will be going into the hospital for a hernia operation this week. Our prayers are with you, Scott.

Patty Lamb and her husband, John, made it to the Inn at Longshore the night of the Spring party, but claim they couldn't find us, so they drove on down to the beach to watch the submarine races instead.

Driving home during one of the late Spring snowstorms, John Klein's windshield wipers quit on him. So inventive passenger Mike Barr leaned out his window, reached across, and played "human windshield wiper". At least Mike is one person who doesn't say "I don't do windows"!

Which "Bachelor-About-Town" recently invited both Cheryl Leveen and Betsy Baker out on the same Saturday night? Commented this Playbear of the Western World, "Well, there's plenty of me to go around."

Richard and Connie Kosheff are rumored to be planning an indoor pool party soon. The torrential April showers we were hit with left their apartment three feet under water.

On June 3rd, there will be a Trivial Pursuit match between SDA and one of our clients. Tryouts for the team will be held this month. We'll keep you posted.

We're looking for someone to design a bannerhead for the newsletter. If interested, contact Diane Theurer or Tom Baer.

Have a good month, and remember: we had the April showers, so be on the lookout for mayflowers, and those damned Pilgrims they carry!

By Diane Theurer and Tom Baer May 1, 1984

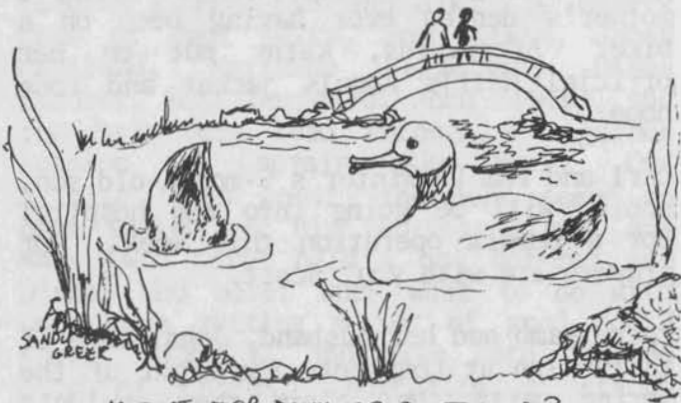

IS THAT TOP-DOWN OR BOTTOM-UP?

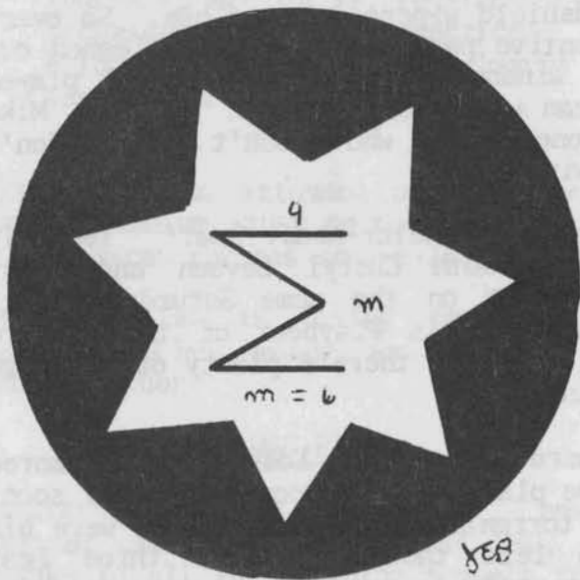

## BUG BULLETIN

It seems that some butterflies can count up to 100. The small white butterflies who lay their eggs on cabbage plants stop laying after 100 eggs have been deposited on a plant, because that is the cabbage plant's maximum capacity. Although this story was reported in The New York Times, April 10, 1974, we remain skeptical as to the existence of hepidopteran mathematical geniuses who have mastered arithmetic base 10. Why not give some credit to the cabbage plant, which begins to droop after the weight of 100 eggs has been deposited on its leaves?

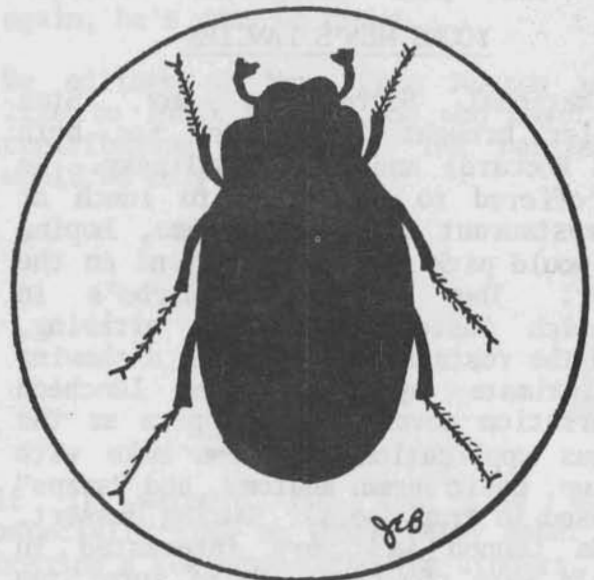

## JUNEBUG

# Tbar<sup>®</sup>

## HOST CONTROL FOR VSM

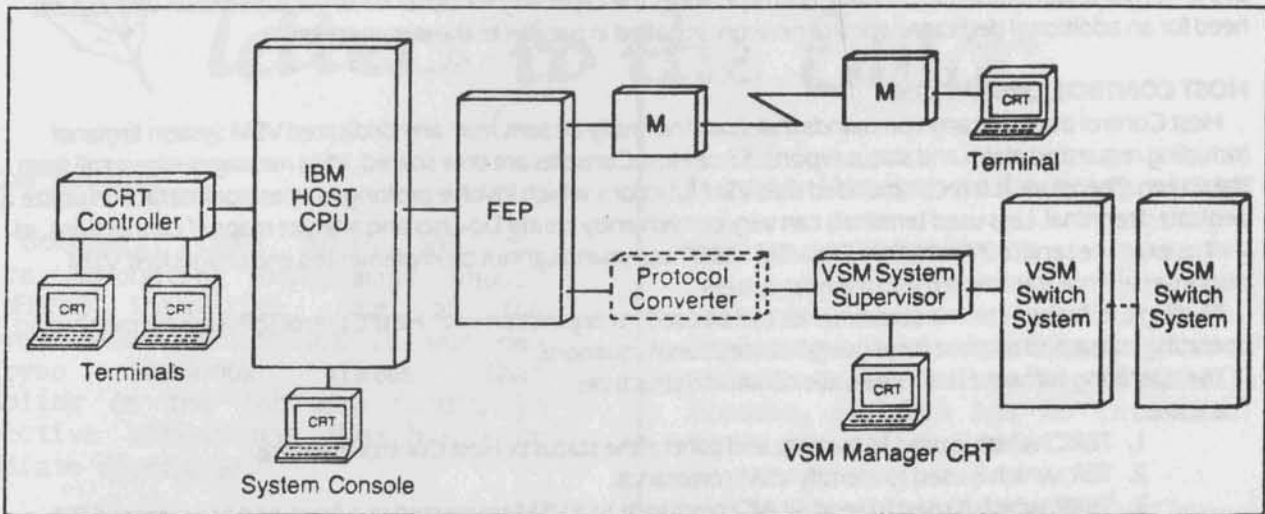

**T-Bar offers an exciting new software product - Host Control. Host Control resides in your IBM\* host system and allows operation of the VSM system from any console CRT connected to a channel controller. It also allows any terminal connected to a front-end processor in the TP network to gain VSM control access, under secure password restrictions. This greatly expands the control and configuration capability of your T-Bar VSM<sup>®</sup> Virtual Switch Matrix<sup>®</sup> switching system.**

### BENEFITS OF HOST CONTROL

- Provides access to and control of your VSM by the central computer operator.
- Provides convenient access for your network coordinator or administrator.
- Provides access to remote VSM systems through your host's network.
- Reduces your investment in dedicated control terminals and reduces the need for a dedicated control network.
- Provides a communications mechanism to serve as the basis of any desired host/VSM interaction; such as event-actuated switching or VSM history file processing.

Host Control operates under CICS/VS (version 1.4 or later), and it operates with almost any MVS. The communications implementation involves either an asynchronous or synchronous front end port at 1200 or 9600 BPS. Transmission between the host and VSM is ASCII full duplex from an IBM 3705/3725 (or equivalent) front end processor under either VTAM or TCAM.

It also operates in a dual 3705 front end processor environment.

A future software release will be able to use the established network communications between host node sites as a means to communicate between VSM system supervisors.

In addition a Host Control version will also be available that provides spooling of the VSM alarm and activity information into the host system's data base. This historical operating information can be requested by any terminal in the system.

\* IBM is a registered trademark of International Business Machines Corporation.

## HOST CONTROL

Host Control software provides even greater security for your VSM system. Additional security may be set by the managing administrator of the system to authorize only specific terminals and/or persons to issue commands. This means that the superior overall security features already provided with VSM SILAC\* software are also incorporated into Host Control. The IBM system operator who has access to CICS, either through the host console or a separate terminal, can now check or modify the connection status of the VSM system. The network coordinator or administrator may not work near a dedicated VSM control terminal yet occasionally participates in closer monitoring of the network, can also benefit. Host Control provides the capability for closer network supervision without the need for an additional dedicated control network installed in parallel to the data network.

## HOST CONTROL OPERATION

Host Control transmits any commands that could normally be sent from any dedicated VSM System terminal including requested alarm and status reports. Since Host Consoles are time shared, VSM messages may scroll from the screen. Therefore, it is recommended that VSM functions which involve prolonged operator interaction utilize a dedicated terminal. Less used terminals can very conveniently create Do-Lists and analyze maps of connections, as well as examine service information. The VSM "LED" command cannot be implemented and unsolicited VSM responses are not transmitted into the host system.

Existing CICS master terminal commands can be used in conjunction with Host Control Software for monitoring operating status and to assist in recovery in exceptional situations.

The operating software has three basic command structures.

These are:

1. TBRC, which is used to monitor and control the status of Host Control interface.
2. TBR, which is used to identify VSM commands.
3. TBRR, which is used to send SILAC commands to a VSM connected to a front-end at a remote CPU, which also contains the Host control software.

## HOST CONTROL SOFTWARE INSTALLATION

Host Control is provided as object code on a tape, 9-track 1600 bpi. There is a sample JCL, in written form, describes how to link edit the software into your load library.

\* Switching Intelligent Language for Automated Control.

# Tbar

INCORPORATED

## Data Communication Systems Division

**Corporate Office**  
T-Bar, Incorporated  
141 Danbury Road  
Post Office Box T  
Wilton, CT 06897  
(203) 834-8368  
TWX: 710-479-3216  
TLX: 681-9129

**T-Bar International  
(Europe) Ltd.**  
Thames Court  
1 Victoria Street  
Windsor, Berkshire  
SL4 1HB England  
44-7535-50156/7/8/9  
TLX: 847085

**T-Bar, GmbH**  
8013 Haar/Munchen  
Hans Pinsel Strasse 9/10 III  
West Germany  
49-89-463030  
TLX: 5213906

T-Bar Switches are manufactured under one or more of the following U.S. patents 4393381, 4394541, and various foreign patents. Specifications subject to change by engineering developments.

©T-Bar Incorporated 1984  
Printed in USA

DS6-5-384

# Feedback

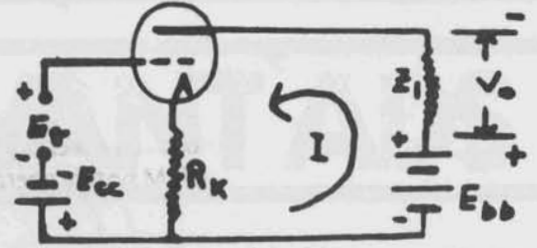

## Letters to the Editor

To the Editor:

Jay Goldberg, Jane Braik and the entire Accounting Department should be fired instantly! One of the general rules of conduct in our new Employee Handbook states that "gambling on the job may result in corrective action and possibly your immediate discharge."

Yet, according to an article in the last issue of the Newsletter, SDA harbors a blackjack program which Jay directed his coconspirators to practice.

How can such iniquity on the job be tolerated? I suggest that a Special Prosecutor be appointed.

Maira L. M'Jorrity

To the Editor:

I guess I'm about to be put out to pasture. For some years now I've been taking PPP, an over-the-counter drug, to ease my rheumatism, and I keep a big bottle of it in my desk, along with a spoon that has become quite sticky with incriminating evidence.

Now I read, in the new Employee Handbook, that "possession, use, or being under the influence of, intoxicants or drugs, unless prescribed by a licensed physician", is punishable by "corrective action and possibly your immediate discharge".

We'll, "So long, it's been good to know you. . ."

I guess I've got to be going along.

Mort de Maintenance

Editor's note: Our Research Department has determined that PPP stands for Papa's Painkilling Placebo, and SDA has no intention to shove you off the roost.

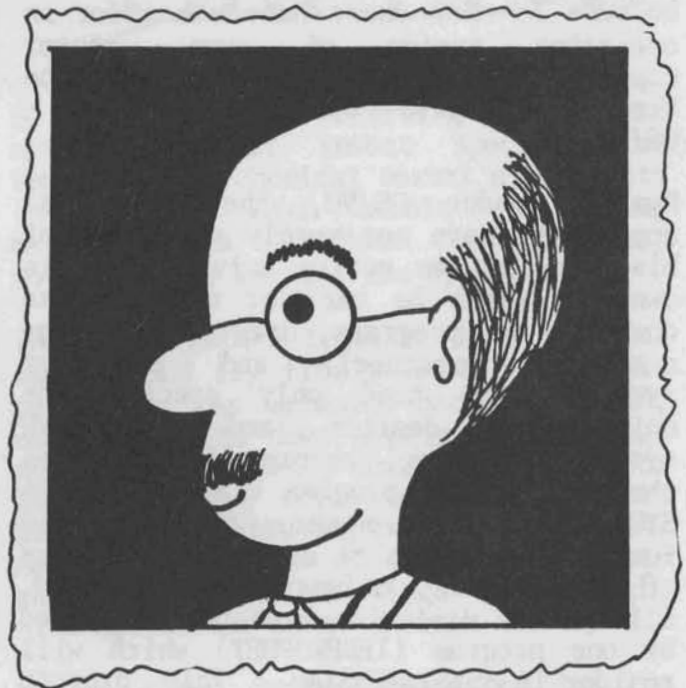

MORT DE MAINTENANCE

### BUG BULLETIN

Monarch butterflies protect themselves against avian predators by extracting from plants a toxic substance similar to digitalis. The poison, which does not harm the butterflies, saturates their tissues, and nonsuicidal birds avoid them like the plague.



### NEW OPERATING SYSTEM

Because so many users have asked for an operating system of even greater capability than VM, IBM announces the Virtual Universe Operating System - OS/VU.

Running under OS/VU, the individual appears to have not merely a machine of his own, but an entire universe of his own, in which he can set up and take down his own programs, data sets, system networks, personnel, and planetary systems. He need only specify the universe he desires, and the OS/VU system generation program (IEBGOD) does the rest. This program will reside in SYS1.GODLIB. The minimum time for this function is 6 days of activity and 1 day of review. In conjunction with OS/VU, all systems utilities have been replaced by one program (IEBPROPHET) which will reside in SYS1.MESSIAH. This program has no parms or control cards as it knows what you want to do when it is executed.

Naturally, the user must have attained a certain degree of sophistication in the data processing field if an efficient utilization of OS/VU is to be achieved. Frequent calls to nonresident galaxies, for instance, can lead to unexpected delays in the execution of a job. Although IBM, through its wholly-owned subsidiary, the United States, is working on a program to upgrade the

speed of light and thus reduce the overhead of extraterrestrial and metadimensional paging, users must be careful for the present to stay within the laws of physics. IBM must charge an additional fee for violations.

OS/VU will run on any IBM x0xx equipped system equipped with the Extended WARP Feature. Rental is twenty million dollars per CPU/nanosecond.

Contributed by Joe Mulqueen

### SAMPLE GREETING CARD: READ DIRECTIONS FIRST

If you should ever think to leave me  
Or in any way deceive me  
I pray your jewels, both left and right,  
Do calcify during the night  
And match in texture, shape and hue  
These lovely baubles colored blue,  
And when this ghastly deed was done  
And purpose for them there was none  
Except to clank when you would walk  
Or provide for ribald talk,  
Then would you remember me.  
Happy Anniversary!

(Attach two large, square metal or  
glass blue objects)

From the collection of unusual greeting  
cards

Eileen Sandalwood



WHAT MAKES US ANGRY?????  
HOW TO HANDLE IT

Anger is almost always a reaction to an inability and/or unwillingness to deal with an initial feeling or stimulus.

Some feelings that stimulate anger are:

- Helplessness
- Fear
- Embarrassment
- Frustration
- Unresolved discontent
- Envy
- Jealousy
- Resentment
- Guilt
- Loss of power
- Unrealistic expectations
- Despair

\_\_\_\_\_ Others  
\_\_\_\_\_  
\_\_\_\_\_

Four steps in resolving anger are:

1. Recognize that you are angry
2. Identify the source (external)
3. Understand why you are angry (internal)
4. Deal with the anger realistically.

Remember:

If you get angry and lose control, that is a choice you make.

No one can make you get angry. You make yourself angry.

If you let other people get you angry, you are giving away an awful lot of power, for you are allowing them to control what you do or say, instead of being responsible for your own actions.

Jack Geringer

ON PANVALET

"Libraries are not made; they grow."

Augustine Birrell

**WANT ADS**

Wanted: People who would like to share apartments with members of the technical staff recently recruited from foreign countries. If you are interested, call Suzanne Wachler or the personnel department (212-741-5200).

Bug  Bulletin

A sex role reversal has been discovered by entomologists observing the ghost moth. In most insect species, the females exude chemical sexual attractants (pheromones) which enable the roving males to track them down. But the ghost moth operates in just the opposite way.

The males gather together shortly after sundown and fly from side to side, like pendulums. As he moves back and forth, each male lets down a pair of hind legs which differ greatly from those used for locomotion and which are covered with fine hairs containing potent pheromones. As the legs dangle in the air, the male ghost moth fans his wings to help the wind spread the scent through the air.

Female ghost moths, attracted by the scent, home in to its source and mate with the males, producing litters of crop-damaging caterpillars.

Pest-control experts have for many years used synthesized pheromones to trap unwary male insects. But trapping males is pretty useless when there are gravid females swarming through the air. In the case of the ghost moth, the females will soon be the victims of man-against-bug chemical warfare, along with their future progeny of plant-destroyers.

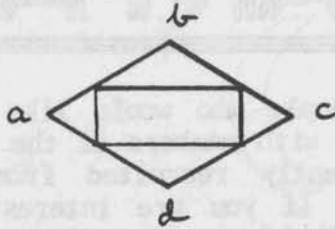
MATHEMATICAL PUZZLESRectangle in Decision Symbol

Two programmers who were waiting for their output whiled away their time by drawing figures with templates. When one of them drew the above figure, the other said, "I wonder what the maximum size is for a rectangle inscribed inside the decision symbol." Assuming, for simplicity's sake, that the distance from b to d is 8 units and the distance from a to c is 12 units, what dimensions of the inscribed rectangle will yield the greatest area?

The Branch Celebration

At a recent SDA check night, a luscious cake was served. Before the cake was cut, the branch manager announced, "We're celebrating some birthdays and anniversaries this month, and it just happens that if you multiply the number of anniversaries by 90 and the number of birthdays by 541, the sum of these products is the current year, 1983."

How many birthdays and how many anniversaries were being celebrated?

A Language Problem

SDA staffed a large project with sixteen programmers, seven of whom knew two languages, none of whom knew neither COBOL nor BAL, and none of whom knew both Fortran and Cobol or both PL/I and BAL. Twelve of the programmers knew COBOL but not PL/I, and five knew BAL but not FORTRAN. There were twice as many BAL and COBOL people as there were PL/I and COBOL people, and twice as many people who knew PL/I as people who

knew BAL only. There were five more COBOL people than people who knew only one language, and half as many FORTRAN people as PL/I people. Can you tell how many in the group knew each language or combination of languages?

The Hungry Mouse

A mouse found a ball of cheese and promptly ate his way right through its center. The tip of his tail was just disappearing when his nose emerged on the other side. The mouse was six inches long. How much cheese was left?

Billing Problem

Two consultants, Junie Junior and Ollie Oldtimer, were sent on a short-term assignment in the ancient principality of Googolmania, where the unit of currency is the googol. They worked a total of twenty man-days. Ollie's daily billing rate was a hundred googols more than Junie's. The customer was billed eighteen hundred googols for Ollie's services and twenty-eight hundred for Junie's.

How long did each consultant work?

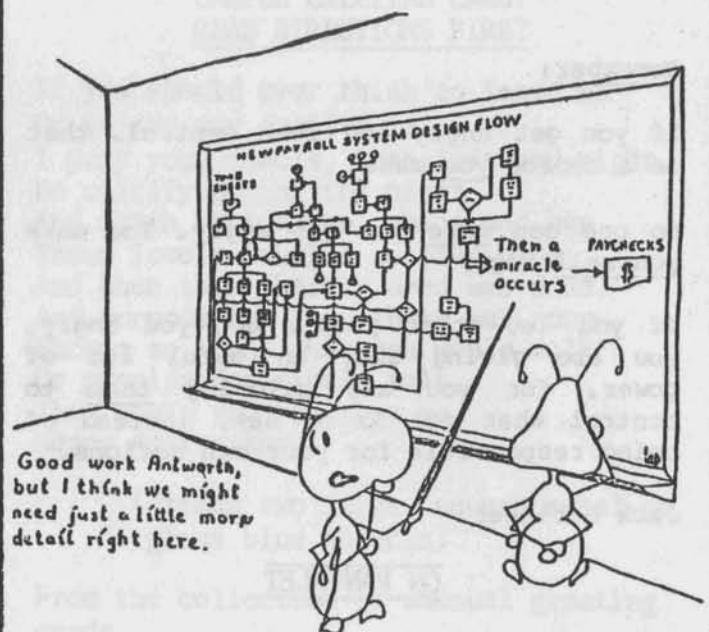

Good work Antwarrh, but I think we might need just a little more detail right here.

# *The Six Project Stages*



Wild Enthusiasm

Disillusionment

Total Confusion

Search for the Guilty

Punishment of the  
Innocent

Promotion of the  
Non-Participants

# PUZZLES

## CROSSWORD

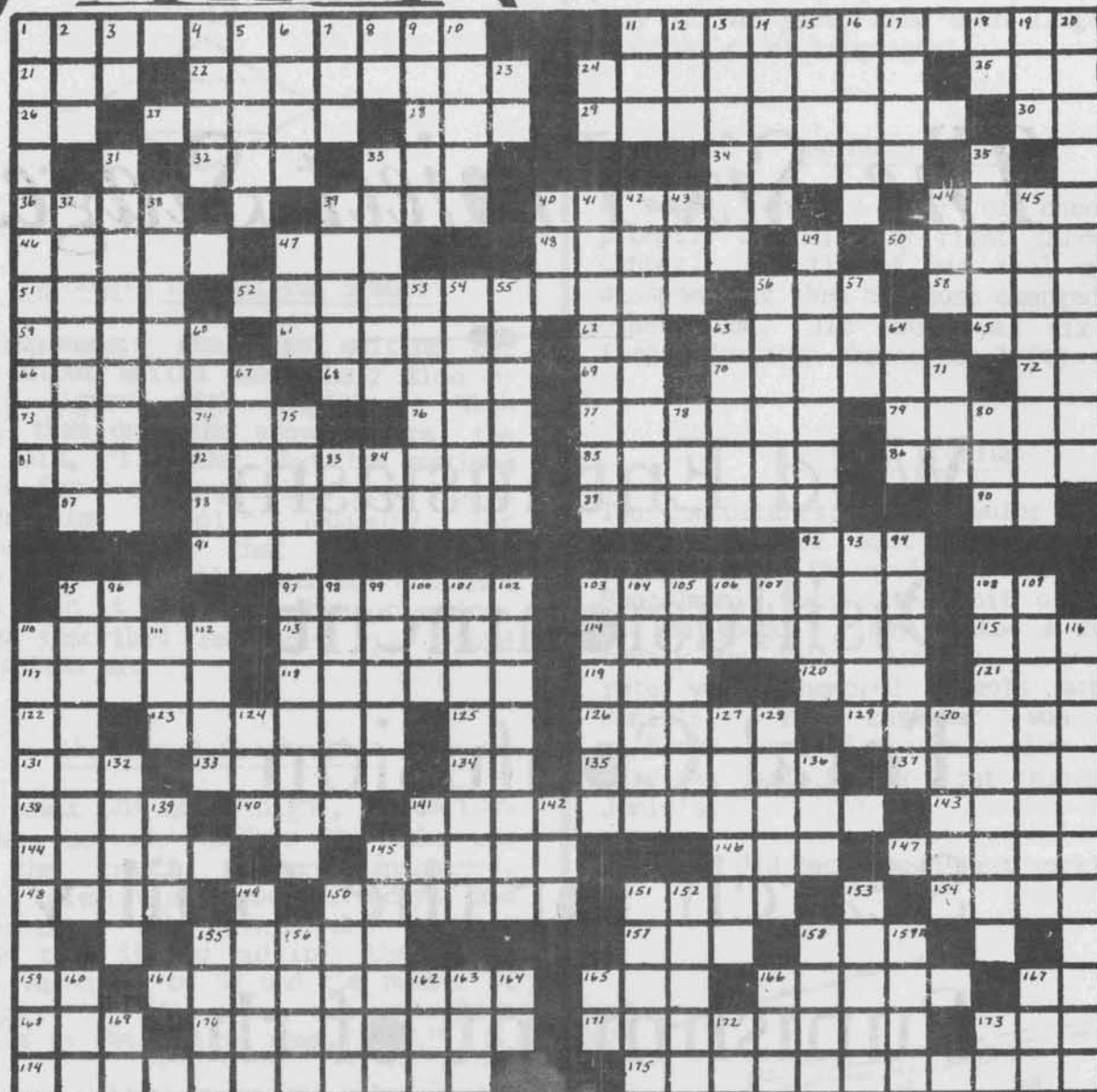

### ACROSS

1. Devices
11. COBOL section
21. Programming language
22. Assign to the same storage locations
24. Excesses of debits over credits or vice versa
25. Chemical suffix
26. Apiece, for short
27. What a GET does
28. COBOL logical operator
29. Writes off by prorating
30. -- Nino
32. Consulting co.
33. Floating-point instruction
34. Member of football team

39. Kind of register
40. Horrify
44. Spooling system from TX
46. Soda fountain treats
47. Qantel V unconditional branch
48. COBOL debugging aid
50. Part of IBM 3800 printer
51. Freshwater game fish
52. Early computer components
56. Floating-point instruction
58. Design or documentation technique
59. Small bay
61. Modern
62. N.Y.C. transit agency
63. Of a Verdi opera
65. Harsh: prefix

- 66. Grassy plains in South America
- 68. More withered
- 69. SS instruction
- 70. Stuffs
- 72. Concerning
- 73. German article
- 74. Part of certain business letter salutations
- 76. New Year's ---
- 77. Ms. De Beauvoir
- 79. Parasitic worms, for short
- 81. C4D5C4
- 82. Small ocean fishes
- 85. Distress or misery, from the Yiddish
- 86. Mild oaths
- 87. Noun suffixes
- 88. Labels of a kind
- 89. Flower parts
- 90. Measure of statistical accuracy, for short
- 91. RX instruction
- 92. Indian dye-yielding plant
- 95. SI instruction
- 97. Processes bread dough with the hands
- 103. Kind of data item not allowed in reentrant program's working storage
- 108. Transcendental number
- 110. Force
- 113. Small loose garment flap or fold
- 114. Space spider Anita's fellow traveller
- 115. COBOL logical operator
- 117. Small computer
- 118. Imagine or conceive
- 119. E9D5D9
- 120. Follower of profit or mountain
- 121. E3E3C5
- 122. Letter addendum
- 123. Red
- 125. Line of code
- 126. Mona ---- smile
- 129. Permanently mounted pack
- 131. Transmission control character
- 133. Couples
- 134. Baseball organization
- 135. Of a Broadway hit
- 137. Kind of instruction on the IBM 1130
- 138. Public disturbance
- 140. --- time for a change
- 141. Important programming task
- 143. Years, to Ceasar
- 144. Word in GDS DD statement
- 145. Leave alone
- 146. College degree
- 147. Unsoiled
- 148. Asses, in Paris
- 150. Abhor
- 151. Juicy fruit
- 154. River in Spain

- 155. Unwanted caresser
- 157. Ms. Rand
- 158. Unit of radiation exposure
- 159. Radioactive element: chem.
- 161. Records for the boob tubes
- 165. Binary digit
- 166. Henry or Jane
- 167. Instruction format
- 168. Address in the PSW
- 170. Kind of character in a string
- 171. Located
- 173. S instruction
- 174. Repository for magnetic tapes
- 175. Translation of high-level language to machine language

## DOWN

- 1. Prepared a program or pseudoprogram for processing by the compiler
- 2. Federal agcy
- 3. Football pos.
- 4. Ron, e.g.
- 5. Piles
- 6. Early Icelandic literary work
- 7. Remaining in real storage, for short
- 8. Of audible sound frequency, for short
- 9. Word in COBOL WRITE statement
- 10. Night noise
- 11. File organization method
- 12. D5D3D6
- 13. Conditional freedom
- 14. COBOL PERFORM option
- 15. E3C3C9D3
- 16. Estonian island
- 17. Important client employee
- 18. Dad
- 19. DECLARATIVES verb
- 20. Use data communications
- 23. Engaging movie character
- 24. College degree
- 31. Scene of recent war
- 33. Sand eel
- 35. Programming language
- 37. Section of COBOL program
- 38. 17th century Dutch painter
- 39. Hillsides, to Burns
- 40. Communications company
- 41. Objects or demonstrates
- 42. Heaven
- 43. Mfr. of 1 across
- 44. Triumphant exclamation
- 45. COBOL SIGN option
- 47. Winter sound
- 49. Possessing a defined storage location
- 53. Tranquil

54. Well, - ----!
55. Mental strain
56. Mr. Hampton
57. Scrap of cloth
60. Glass-raisings
63. Ancient Greek marketplace
64. COBOL DC verb
67. COBOL verb to establish logical position in indexed file
71. Floating-point instruction
- 75.
78. Office cleaner's implement
80. Message format specification
83. Popular princess
84. Not: prefix
- 93.
94. Of the woman who said, "There'll be a hot time in the old town tonight!"
95. A leaving out (of necessary code)
96. C9D7C3
98. Opposite of zeniths
99. Fencing swords
100. River flowing through Brazil and Paraguay
101. Explode
102. Libraries specified in JCL
103. Knave
104. Come
105. Dried fruit
106. Footnote abbrev.
107. One, to Burns
108. Sponsor
109. Kind of reader
110. Obsolescent
111. C5D9C3
112. Logic bug
116. Message target
124. Spring month, in Marseilles
127. Cossack chief
128. Less crazy
130. Easily split rock
132. Programmer
136. College degree
139. Of a rare nonmetallic element: chem.
141. Encountered
142. TP system
145. Spanish province
149. Game dish
150. Reformist Chicago mayor of the 20's
151. Kind of button
152. With an ---
153. Control ----
155. Rind
156. Beatrice or Sidney
158. Roasted on a spit
- 158a. Early 20th century artistic cult
160. IMS call parameter
162. IMF reserve asset
163. C5C5E8

164. M.W. state
165. IBM software product
166. IBM 7094 assembler language
167. Privileged instruction
169. Input, for short
172. Hesitant sound
173. Note of the scale

### SOLUTIONS TO MATHEMATICAL PUZZLES

#### Rectangle In Decision Symbol

Horizontal sides      6 units  
Vertical sides        4 units

Method: Plane geometry, algebra and either calculus or plotting a graph

#### The Branch Celebration

There were 3 birthdays and 4 anniversaries.

Method: Diophantine equations (equations which can have only integral solutions). Equations of this type have either no solution or an infinite number of solutions. The context of the problem will pinpoint the unique solution.

#### A Language Problem

BAL	1
COBOL	8
BAL & COBOL	4
PL/I & COBOL	2
BAL & FORTRAN	1

Method: logic

Bonus question: Can you present the problem with fewer clues, retaining its solvability?

#### The Mouse and the Cheese

36 cubic inches

Method: Solid geometry

## Billing Problem

Junie Junior 14 days  
Ollie Oldtimer 6 days

Method: Quadratic formula

YOU MUST HAVE BEEN A BEAUTIFUL BABY  
YOU MUST HAVE BEEN A WONDERFUL CHILD

The pictures are of Wynelle Plattner and Tom Kernan, both of the Phoenix branch.

## ANSWERS TO LAST ISSUE'S PUZZLES

### CROSSWORD

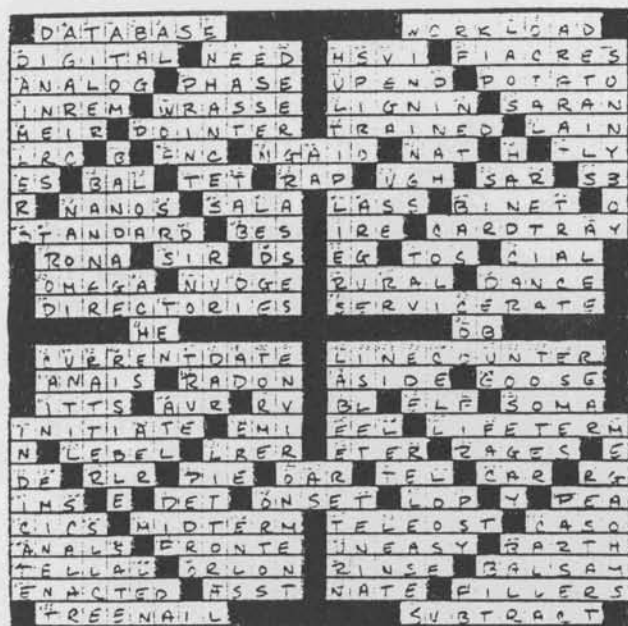

## THE NEW WAVE



I DON'T GET ALL THESE  
PUNCHED CARD JOKES!

## BUG BULLETIN

### Another Falkland Islands War

The British Defense Ministry has launched another Falkland Islands war, not against Argentina this time, but against huge swarms of locusts which threaten to disrupt Britain's air links with the Falklands by filling the airways around Ascension Island, a stopping off point for flights between Britain and the Falklands. The ammunition, of course, is insecticides sprayed by extermination specialists on the locust eggs before the pests become airborne. This problem occurs about every twenty-five years.

## QUIRKY QWERTY

Did you ever wonder why the standard typewriter or terminal keyboard starts with QWERTY?

According to Karl Albrecht of Karl Albrecht & Associates in San Diego, this familiar keyboard layout is a quirk of history.

It seems that Christopher Sholes, 19th century typewriter pioneer, found that Gertie the typist dirtied her hands unscrambling keys which jammed each other when she typed so fast that one key could not return from the paper quickly enough to avoid collision with the next descending key. To alleviate this problem, Sholes designed a new keyboard layout the sole purpose of which was to slow typing speed.

In these days of fast electric typewriters and terminals without mechanical keys, the QWERTY keyboard is an anachronism which should be replaced either by the old layout which it replaced or by a new layout to replace both. Albrecht favors the "Dvorak keyboard for personal computers." Do any of you readers out there know what the Dvorak keyboard looks like? If so, please send the editor a letter describing it. Remember, we do have a "Feedback" column.

