

Now Canada's Largest Computer Monthly!

What's New  
in Consumer  
Electronics

CANADA'S COMPUTER INFORMATION SOURCE

# The **COMPUTER PAPER**

NEWS REVIEWS FEATURES

Free!

ONTARIO EDITION FEBRUARY 1994  
VOLUME 7 NO. 2

## Making **Powerful** Presentations

## Exploring the Internet

## Macworld Show Report

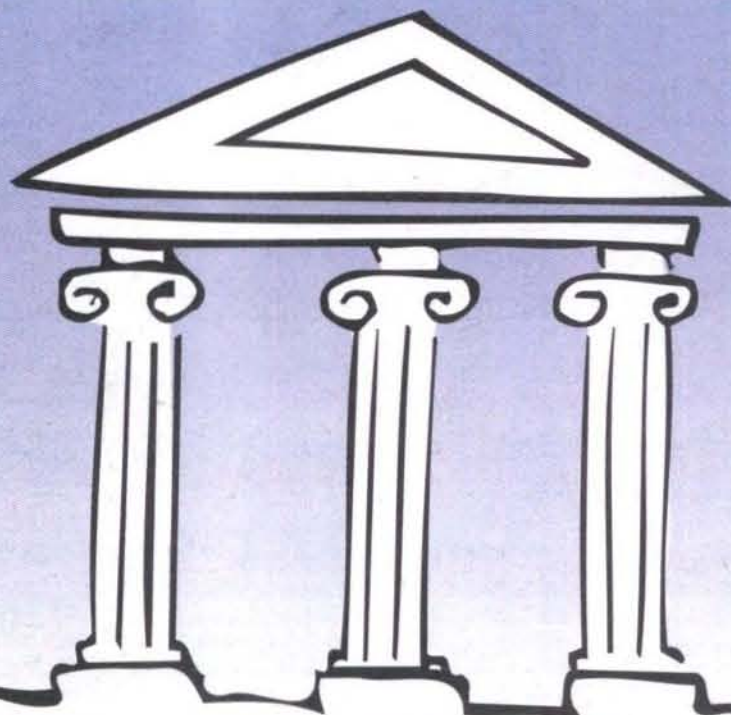
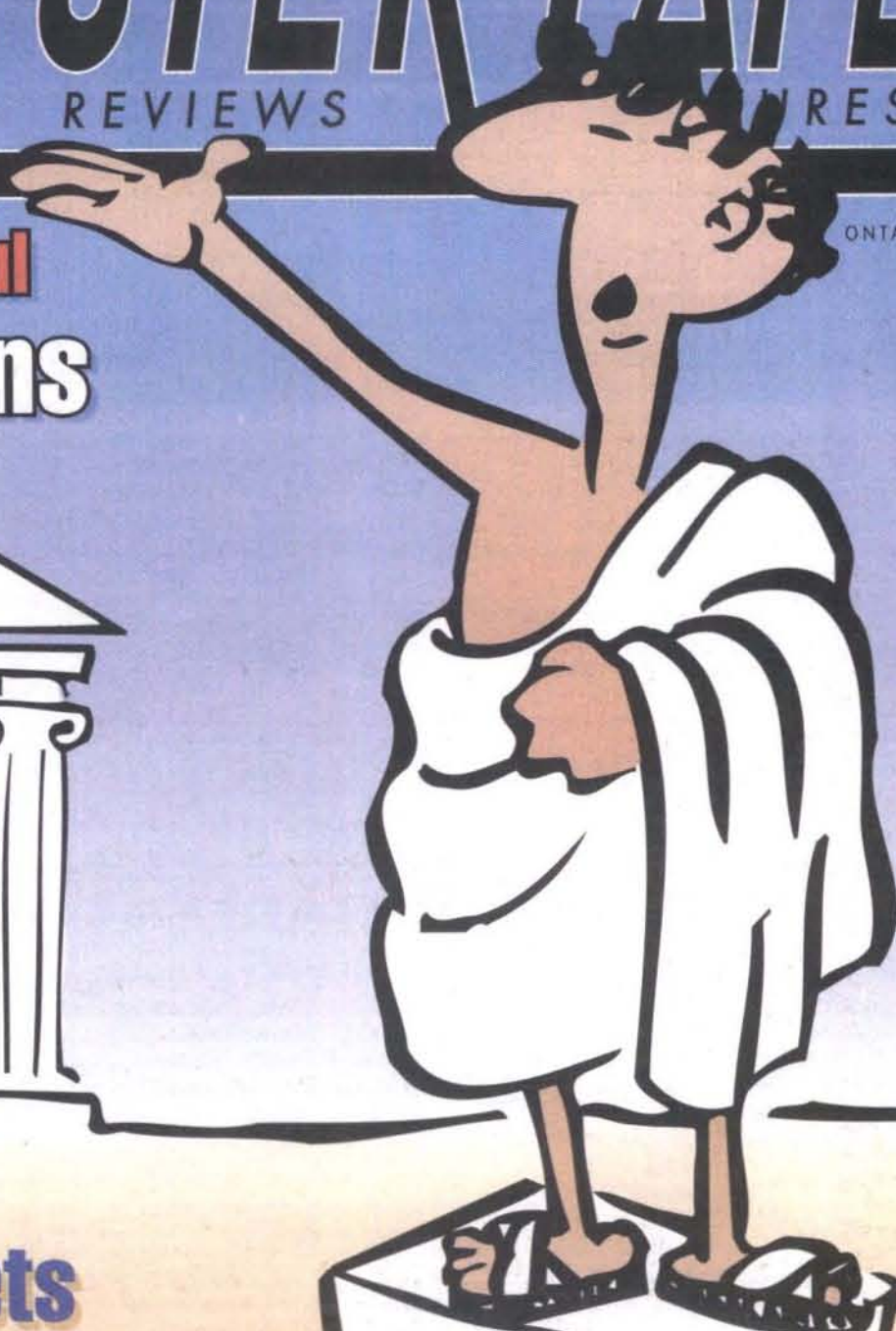

## PC Spreadsheets

Hot new releases from  
Borland, Microsoft, Lotus,  
and Computer Associates

## Personal **Tax** Software

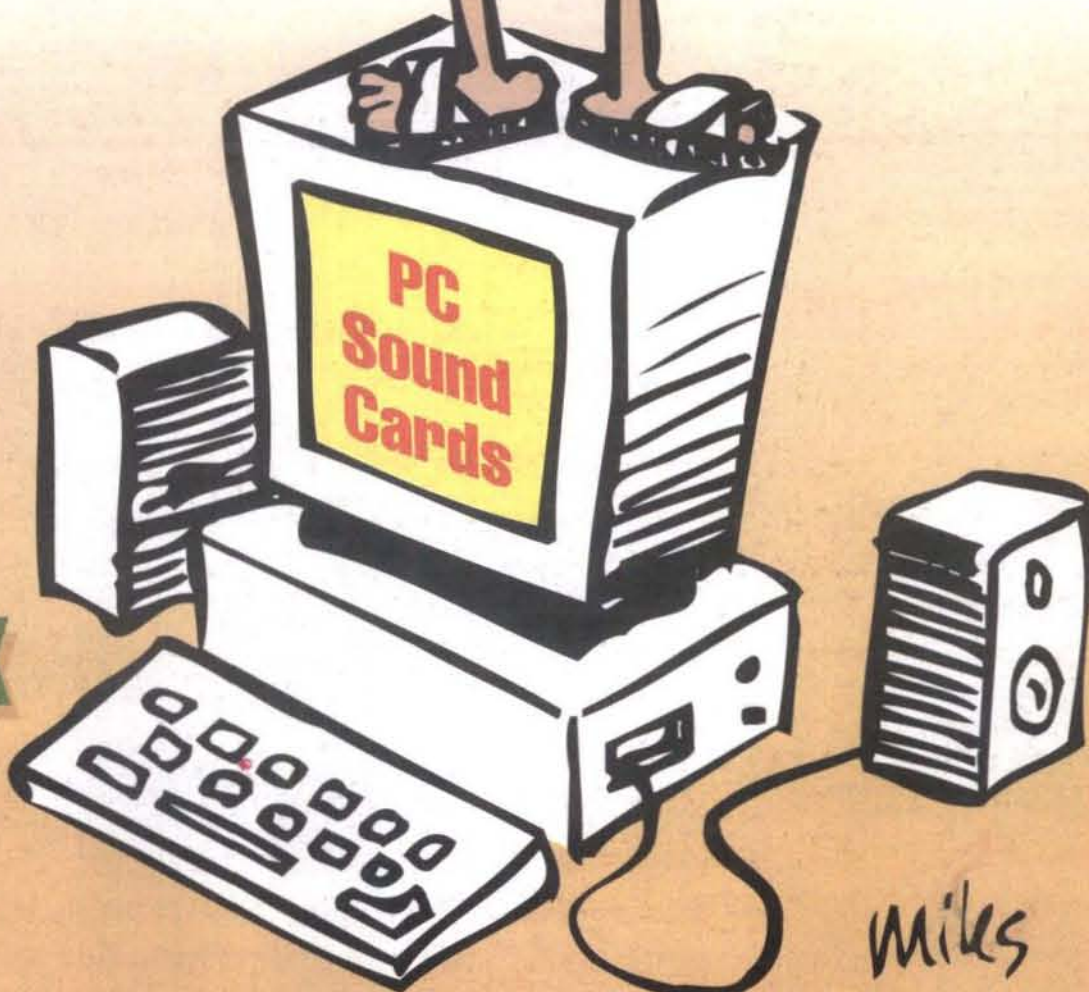

**Hurdla 486DX-33**  
 4 MB RAM  
 170 MB Hard Drive  
 SVGA Monitor .28 dp  
 1 MB Video Card  
 Local Bus  
 Mouse  
 DOS 6.0 & Windows 3.1  
 MS WORKS for Windows  
 Lotus Organizer



**\$2399**



**3 year limited warranty**  
**Easy to learn and fun. For the whole family!**

**Multimedia System**

**E92 486SX-25 / 4 MB RAM**  
 170 MB Hard Drive  
 CD-ROM Drive / Sound Blaster 16  
 SVGA Monitor .28 dp  
 1 MB Video Card  
 Modem, Mouse, Speakers  
 DOS 6.0 & Windows 3.1  
 MS WORKS for Windows  
 Comptons 1993 Encyclopedia  
 Mayo Clinic, King's Quest 6



**\$2449**

**3 year limited warranty**  
**Reliability and quality you can depend on**



Novell Network  
 Light 1.1 \$69  
 Novell Network  
 3.12 5 user \$849  
 Novell Network  
 3.12 10 user \$1999  
 Novell Network  
 3.12 25 user \$2899  
 Novell Network  
 4.01 10 user \$2599  
 MS Workgroups 3.11  
 Add-on \$79.95  
 MS Workgroups  
 + Windows 3.11 \$199  
 Lantastic 5.0-2  
 user AE2 kit \$629  
 1 add-on AE2 user  
 w/hard \$289

BNC Connector  
 or RG58 \$1.95  
 BNC Connector  
 or RG62 \$1.95  
 Terminators  
 50 ohms \$3.95  
 T-Connectors \$4.95  
 Couplers \$4.95  
 Coax cable  
 RG58/RG62 \$.40/ft  
 8 bit Ethernet card \$119  
 16 bit Ethernet card \$119  
 32 bit Ethernet card \$479  
 8 bit Arcnet card \$85  
 16 bit Arcnet card \$139  
 Arcnet 4p passive  
 hub \$29  
 Arcnet 8p active hub \$249

**CD-ROM SOFTWARE**

Hellcab \$79.95  
 Day of the Tentacle \$51.95  
 Dracula Unleashed \$69.95  
 Return to Zork \$59.95  
 King's Quest 6 \$29.95  
 Tony Larussa Baseball 2 \$51.95  
 Rebel Assault \$59.95  
 Authur's Teacher Troubles \$34.95  
 Just Grandma & Me \$44.95  
 Iron Helix \$77.95  
 Might & Magic-Xeen \$52.95  
 Comptons Interactive Upgrade \$109.95  
 Eye of the Beholder Trilogy \$72.95  
 7th Guest \$44.95  
 Where in the World is Carmen? \$34.95

**IBM SOFTWARE**

Jeopardy Alex \$29.95  
 X-Wing Mission 2 \$24.95  
 Links: Pebble Beach Course \$32.95  
 NHL Hockey \$58.95  
 Indy Car Racing \$54.95  
 Links: Firestone Course \$24.95  
 Leisure Suit Larry 6 \$48.95  
 Aces Over Europe \$48.95  
 Terminator Rampage \$55.95  
 Reader Rabbit 3 \$44.95  
 Print Shop Deluxe \$62.95  
 Mavis Beacon 3.0 \$35.95  
 Treasure Mathstorm \$35.95

**On-site installations available**

**An Entirely Windows Driven BBS**  
**Call For Free Demo**

**BBS (416) 969-8269 or BBS (905) 709-0109**



**MULTIMEDIA MAYHEM!!!**



Toshiba 3401 SCSI external \$699  
 Panasonic 562 ROM drive \$299  
 Omni CD by SoundBlaster \$399  
 Digital Edge by SoundBlaster \$839  
 Sony CDU561 internal w/kit \$539  
 SoundBlaster Pro Deluxe \$139  
 SoundBlaster Pro 16 \$169  
 Wave Blaster \$339  
 Rebel Assault \$59.95  
 Multimedia Mozart \$39.95  
 Microsoft Beethoven \$79  
 Microsoft Bookshelf 1993 \$69.95  
 Microsoft Encarta 94 \$129.95  
 Microsoft Musical Instruments \$79.95  
 Microsoft Cinemania 94 \$69.95  
 Dinosaur Adventure \$29.95

Day of the Tentacle \$51.95  
 Links Collectors CD \$44.95  
 Mayo Clinic \$34.95  
 Family Doctor \$29.95  
 Doctor's Book Home Remedies \$29.95  
 Carmen San Diego Deluxe \$34.95  
 OS/2 Shareware 1994 \$29.95  
 Night Owl 10 \$59.95  
 Phoenix 4.0 \$29.95  
 Sherlock Holmes Consulting \$29.95  
 Comptons Encyclopedia 1993 \$299  
 Comptons Interactive Upgrade \$109  
 King's Quest 6 CD \$29.95  
 Dracula Unleashed \$69.95  
 Kodak Photo CD Access \$19.95

Oxford Dictionary  
 2nd edition \$1,149  
 Travel Planner \$44.95  
 7th Guest \$44.95  
 Corel Artshow 4 \$59.95  
 Mitsumi 280ms \$229

**SOUND CARDS**

SB Pro 16 ASP \$299  
 SCSI 2 \$299  
 Gravis Ultrasound \$159  
 Logitech Soundman 16 \$159  
 Pro Audio Spect.16 \$239  
 Pro Audio Studio \$319

**NEW**

**We can back up your hard disk onto a CD-ROM for you!!!**



**Call for info. And pricing**

**CONTROLLERS**  
 Super I/O Card \$24  
 VESA IDE w/2s,1p \$69  
 Adaptec 1522 kit \$189  
 Adaptec 1542CF kit \$349  
 Adaptec 2742AT kit \$399  
**FAX/MODEMS**  
 96/24 fax/modem \$64  
 14.4 internal s/r \$179  
 14.4 external s/r \$209  
 Supra 14.4 internal \$199  
 Supra 14.4 external \$239  
**HARD DRIVES**  
 270 MB IDE \$329  
 340 MB IDE \$399  
 452 MB IDE \$569  
 Quantum 525 MB IDE \$749  
 Quantum 1.05 GB \$1,199  
**SCANNERS**  
 Logitech 32 w/OCR \$159  
 Logitech 256 \$219

Logitech 256 w/ocr \$279  
 Logitech color \$549  
 Logitech color/ocr \$599  
**VIDEO CARDS**  
 Mono \$19  
 512 K VGA \$59  
 1 MB SVGA Card \$99  
 ATI 2 MB Ultra Plus \$289  
 ATI 2 MB VLB Ultra Pro \$449  
**TAPE/DIGITIZERS**  
 120 MB internal \$149  
 250 MB internal \$199  
 120 MB external \$299  
 250 MB external \$379  
 Trakker 250 external \$458  
**MONITORS**  
 14" VGA \$259  
 14" SVGA inter. \$299  
 14" SVGA non-int. \$369  
 17" SVGA non-int. \$1,129  
 20" SVGA non-int. \$1,799

**MOTHERBOARDS**  
 386SX-33 \$99  
 386DX-40 128 K cache \$189  
 486DX-33 256 K cache \$539  
 486DX-50 256 K cache \$699  
 486DX2-66 256 K cache \$799  
**NEC MONITORS**  
 NEC 3V \$699  
 NEC 3FGE \$779  
 NEC 4FGE \$929  
 NEC 5FGP \$1,999  
 NEC 5FGE \$1,429  
**HEWLETT PACKARD**  
 HP 500C \$549  
 HP 550C \$799  
 HP 4P \$1,379  
 HP 4 \$1,999  
 HP 4M \$2,799  
**NOTEBOOKS**  
 AST Bravo 486SX25 4/120 \$2,249  
 Toshiba T1950 CT 4/320 \$4,499

NEC Versa 486SL33 4/180 \$4,349  
 Terranote 486SX25 4/120 \$2,289  
 486SX25 4/120 active color \$4,399  
 TITM4000 486DX25 4/120 \$2,749  
 Zenith Z-STAR 486SLC-33 4/80 \$1,899  
 Compaq Contura 486/25 4/120 \$2,498  
 IBM Thinkpad 350c 4/250 colour \$3,699  
**INKJETS & LASER PRINTERS**  
 Lexmark IBM 4029-20 \$1,299  
 Lexmark IBM 4029-30 \$1,499  
 Lexmark IBM 4039-1or \$1,899  
 Lexmark IBM 4039-12L \$3,199  
 Lexmark IBM 4039-16L \$3,799  
 Lexmark 4072 Execjet \$849  
 Lexmark Color Jet PS \$3,299  
 Epson Stylus 300 \$329  
 Epson Stylus 800 \$379  
 Epson Action 1500 \$859

**PANASONIC**  
 1150 \$189  
 2023 \$239  
 2123 \$279  
 2124 \$379  
 2180 \$199  
 2624 \$489  
 4410 Laser \$739  
 4430 Laser \$898  
 4440 Laser \$1,479



**CMSI**

404 Steeles Avenue West, Unit 5  
 Thornhill, Ontario L4J 6X3  
 Phone: (905) 889-1616  
 Fax: (905) 889-1199

Monday: 9 am - 9 pm  
 Tuesday: 9 am - 9 pm  
 Wednesday: 9 am - 9 pm  
 Thursday: 9 am - 9 pm  
 Friday: 9 am - 9 pm  
 Saturday: 9 am - 6 pm  
 Sunday: 12 pm - 6 pm

All Pricing is already cash discounted • Some quantities may be limited.

Introducing  
The World's First  
Easy Laser Printers.

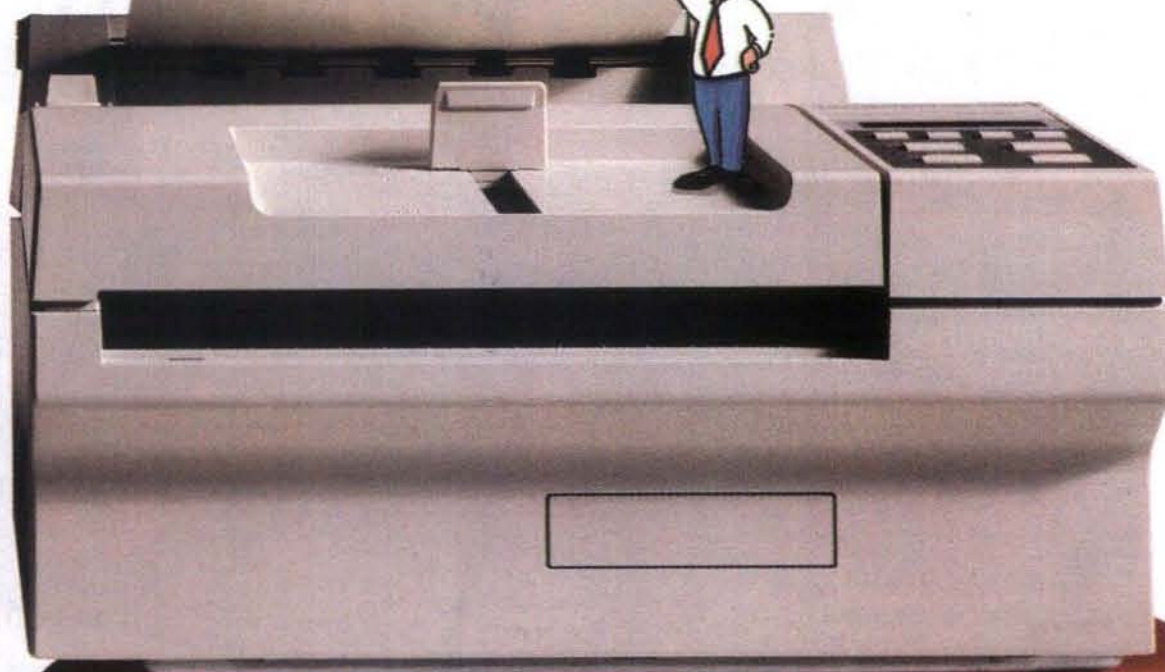

# EASY

Here's some really big news for the little guy. Introducing the world's first EASY laser printer. The Citizen ProLaser 6000.<sup>™</sup>

The Citizen ProLaser 6000 is the only laser printer you can get with the features you want, and the "easy" you need. Just like the big-guys, we have a list of impressive features (you techies can check it out below). But what's really important is that it's easy to buy because everything's included. It's easy to use because you just plug it in and it works. And it's easy to look your best with lots of internal fonts and print quality that'll make you OOH and AAH.

So why do we put so much in a laser printer that costs so little? Hey, we're Citizen. We've been making dot-matrix printers that way for years. And besides, someone's got to look out for the little guy.

#### TECHIE SPEC BOX

The Citizen ProLaser 6000's features include a single component imaging cartridge, HP LaserJet III (PCL-5) compatibility, a reliable internal paper tray, 34 internal fonts, 6 PPM output, a 32-bit RISC processor and much more. Pretty good, huh?

**ProLaser** CITIZEN **6000**  
Easy To Buy, Easy To Use, Easy To Look Your Best.



## PEACE OF MIND

There's never been a better time to buy an Ambra. Now, not only will you get a host of features at an affordable price, but on these special Ambra packages we've contracted with IBM HelpWare to give you a full three-year warranty. That's a full one year on-site, and two more years of depot service, plus lifetime support through HelpPC, a toll-free technical support line, 24-hours a day, 7-days a week.

## FEATURES

Ambra is new directions, and new thinking. It's the blazing fast Blue Lightning chip, giving you 66Mhz performance at a 33Mhz price by doubling internal clock speed while maintaining full 486 compatibility. It's the latest technology—full-fledged 64-bit Pentium™—for less. And it's innovation, like an encrypted CD-ROM disc, that lets you try-before-you-buy over 80 popular software packages.



## BEST BUY

PC WORLD selects Ambra Blue Lightning "The most 486 for your money." No wonder, when every Blue Lightning comes Pentium Overdrive™ ready (P24T) and equipped with 8MB RAM, 256KB cache, on-board SCSI and Ethernet adapter, Local Bus Video, 2 VESA local bus slots as standard.



## GUARANTEE

If you're not happy with your new Ambra, we'll give you your money-back. If for any reason you're not absolutely satisfied, simply return it within 30 days for a full refund.



# Don't Worry.



# Be Happy.



80 popular software packages to try.

66 Mhz for the price of 33Mhz.

Full-fledged Pentium technology for less.

24-hours, 7-days a week lifetime support.

PC WORLD's "BEST BUY".

Call Today.  
**1-800-363-0066 Ext.835**  
Available Only By Phone.

## CHOICES

Here are a few special offerings:



### \$2999

Including 14" SVGA LR Monitor

486 Blue Lightning processor • 66 Mhz • Pentium OverDrive™ ready (P24T) • 8 MB RAM • 240 MB hard drive • 256KB processor cache • Local Bus Video • Video Accelerator • 1 MB Video RAM • 2 VESA local bus slots • on-board SCSI interface and Ethernet adapter • CD-ROM with sound card • 5 slots x 5 bays • mouse • MS-DOS 6.0 and Windows 3.1

### \$3499

Including 15" FST Monitor

486 Blue Lightning processor • 66 Mhz • Pentium OverDrive ready (P24T) • 8 MB RAM • 440 MB hard drive • 256KB processor cache • Local Bus Video • Video Accelerator • 1 MB Video RAM • 2 VESA local bus slots • on-board SCSI interface and Ethernet adapter • CD-ROM with sound card • 5 slots x 5 bays • mouse • MS-DOS 6.0 and Windows 3.1



### \$4249

Including 14" SVGA LR Monitor

Intel 486DX2 • 66 Mhz • Upgradable to true 64-bit Pentium technology • 8 MB RAM • 340 MB hard drive • on-board dual-channel fast SCSI • 256KB processor cache • 2 VESA local bus slots • 8 32-bit EISA slots & 12 bays • Local Bus Video • Video Accelerator • 1 MB Video RAM • mouse • MS-DOS 6.0 and Windows 3.1 or OS/2 2.1 for Windows



### \$5999

Including 15" FST Monitor

Intel 60 Mhz Pentium processor • 64-bit processor complex • 8 MB RAM • 540 MB SCSI hard drive • 256KB processor cache • ATI Ultra Pro Mach 32 2 MB VRAM • CD-ROM with sound card • 8 32-bit EISA slots and 6 bays with 2 VESA local bus slots • mouse • MS-DOS 6.0 and Windows 3.1



## AMBRA

HIGH PERFORMANCE

A product of ExperComp Services Ltd.,  
a subsidiary of IBM Canada Ltd.

On-site warranty may not be available in certain remote locations. \*Warranty and 30 day money-back guarantee information available through Ambra. Please call 1-800-363-0066 for details regarding Ambra's money-back guarantee and 3-yr. warranty. Copies of the terms of Ambra's guarantee are available upon request. One-year on-site service at no additional charge during warranty. Shipping, handling and applicable taxes not included in the price. The Intel Inside Logo, Pentium and OverDrive are trademarks of Intel Corporation. Windows is a trade-mark of Microsoft Corporation. OS/2 is a registered trade-mark of IBM Corporation. IBM is a registered trade-mark and is a trade-mark of International Business Machines.

# C O N T E N T S

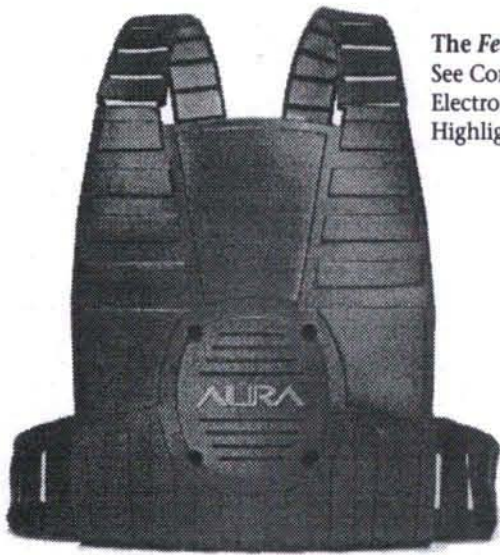

The *Feelies* Arrive  
See Consumer  
Electronics Show  
Highlights, p.61

**COVER STORY**

## 16 Basic Sound Cards for the PC

By Philip Moore

## FEATURES

**PRESENTATIONS**

**23 Making Great Presentations on Your PC**

By Michael O'Donnell and Gary Leonard

**26 Creating Multimedia on Your PC**

By Graeme Bennett

**PERSONAL TAX**

**32 Personal Tax Software**

By Frank Hilliard

**SPREADSHEETS**

**37 The New World Of PC Spreadsheets**

By Alan Salmon

**39 Lotus Adds Multimedia Feature to 1-2-3**

By Grant Buckler

**40 Footprint Works for OS/2**

By John F. Boyce

**42 Quattro Pro 5.0 for Windows**

By Keith Schengili Roberts

**44 Borland looks at Natural Work Groups**

By David Tanaka

## REVIEWS

**SHOW REPORTS**

**12 World Of Commodore**

By Graeme Bennett

**50 Macworld Report**

By Douglas Alder

**58 Consumer Electronics Show**

by Hari Singh Khalsa

**BOOK REVIEWS**

**65 This Old PC**

**65 Updated Dictionary**

**66 Protecting Your Computer Against Attacks**

**67 Photoshop Help**

**COMMTALK**

**68 The Musical Underground, Internet Style**

By James MacFarlane

**TELECOMMUNICATIONS**

**70 Project Gutenberg**

By Keith Schengili-Roberts

**71 BBS Scanning**

By James MacFarlane

**MULTIMEDIA**

**64 3-D Dinosaur Adventure**

By Graeme Bennett

**73 Underwater Multimedia**

By Keith Schengili-Roberts

## NEWS

- 11 Canadian Product Launch
- 25 MPC Standard Explained
- 36 More Personal Tax Packages
- 48 IBM Pioneer Dies at 79
- 49 Video For Windows 1.1
- 53 MacWorld Briefs
- 55 Common Ground For Win
- 56 General Magic Demos Cap
- 57 Compton's Patent, Take 2
- 60 CES News Briefs
- 61 Picks of the CES
- 72 Forte, Advanced Gravis Work On Virtual Reality Project
- 72 Wintertree's Spell Checker
- 74 Pen PC's To Help Out At '94 Commonwealth Games
- 84 Immersion School Offers PC Careers
- 84 Info Highway Leads To Toronto
- 85 TSE Delays Automated Trading

- What's New Highlights
- 76 Canon Funds Wildlife
- 76 3D Does Commodore
- 76 Logitech Sets Up Cdn. Office
- 78 Cars By Fax
- Newsbytes Highlights
- 80 Software Suites Popular
- 80 Oh Waiter . . .
- 81 Worldwide PC sales Up
- 81 Computer Dummies

## DEPARTMENTS

- 6 Mailbox
- 8 Letter from the Editor
- 76 What's New
- 79 Newsbytes
- 82 Q&A
- 82 Training
- 85 User Groups
- 86 Calendar of Events
- 86 Classifieds
- 88 Computer Directory
- 89 Index of Advertisers

### COMING UP IN ONTARIO EDITION

**MARCH**

Telecommunications

Classifieds Mon., Jan. 31  
Ad deadline Wed., Feb. 2  
Distribution Fri., Feb. 18

**APRIL**

Desktop Publishing

Classifieds Mon. Feb. 28  
Ad deadline Wed., Mar 2  
Distribution Fri., Mar. 18

**MAY**

Home Office Computing

Classifieds Mon., Mar. 28  
Ad deadline Tue., Mar. 29  
Distribution Fri., Apr. 15

Call Now  
**(416) 588-1580**  
for advertising  
information.

Advertise in the new  
Eastern Edition of  
*The Computer Paper*  
Toronto (416) 588-1580  
Ottawa (613) 729-7306  
Quebec & Atlantic  
1-800-465-3517

# Affordable UNIX For Enthusiasts

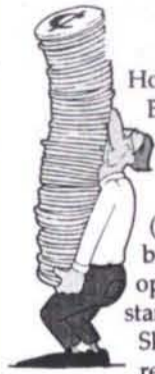

How to master Unix inside out quickly? You may buy and read Unix books. But, this is like learning driving only by reading instructions. Here we offer a way: Turn your 386 or 486 into a Unix workstation and practice. Still, you can keep your DOS or OS/2 on the same PC.

Introducing a full-featured Unix system from Texas A & M University (TAMU) which, conforming to IEEE's POSIX.1 standard, combines the best of both System V and BSD Unices and incorporates a complete development environment, including C and C++ compilers and several hundred standard Unix utilities widely found in SUN, HP and DEC workstations. Skills learned from it are transferable to any other Unix system and get you ready to master all these workstations. With TAMU you can also practice Unix-style networking and system administration as well as X Window programming. Skills in these areas are highly in demand now. Earning a degree doesn't necessarily make you a Unix wizard, hacking TAMU does!

The cost of such a career investment is only \$99. (15 HD 3.5" s). With the system you get:

- A fully tested step-by-step installation guide.
- A well-written tour of the system (Also an introduction to Unix).
- A list of best Unix books recommended by Internet Unix gurus.
- Two boot disks (3.5" & 5.25") for your convenience.
- A program that partitions your HDs without destroying any data.
- Friendly knowledgeable technical assistance. Got a question? Just ask!
- 30 day money back guarantee if you can't bring up the system.

To order, visit our lab or send a cheque or M.O. (add \$5 for shipping plus 15% PST & GST) with address to us. After installing TAMU you can join our two month correspondence course designed to lead you into Unix wizard-hood fast and effectively. Please call or write for a complete listing of our services.

## Sunni Microlab

421 King Street North, Waterloo, Ontario N2J 4E4

Tel: 519-746-2582 Fax: 519-746-3580

A Unique Unix Enthusiasts' Hobby Shop



**EDITORIAL**  
**PUBLISHER / EDITOR** Douglas Alder  
**MANAGING EDITOR** Graeme Bennett  
**NEWS EDITOR** David Tanaka  
**CONTRIBUTING EDITOR** Geof Wheelwright  
**CONTRIBUTING WRITERS** Graeme Bennett  
 Gord Goble  
 Joan Hornal  
 James MacFarlane  
 John Mulvihill  
 Keith Schengill-Roberts  
 Geof Wheelwright

**NEWSBYTES**  
**CANADIAN EDITOR** Grant Buckler

**PRODUCTION**  
**PRODUCTION MANAGER** Kit Griffin  
**PRODUCTION STAFF** Ron Braunagel  
 Kim Fedor  
 Carolyn Howse  
 Jana Kolar  
 Ernest Stelzer  
 Kent Barrett  
 Comstock  
 Graeme Bennett  
 Diana Primavesi

**ACCOUNTING & ADMINISTRATION**  
**SALES MANAGER** Hari Singh Khalsa  
**CONTROLLER** Christine McPhie  
**ASSISTANT CONTROLLER** Laura Waddington  
**ACCOUNTING ASSISTANT** Kari Eichler  
**ADMINISTRATION** Amrit Kaur Khalsa  
**SECRETARY-TREASURER** Kathryn Alexander

**SUBSCRIPTIONS**  
 To have 12 issues of *The Computer Paper* mailed directly to your home (in Canada), send a cheque for \$24.95 to Suite #8, 3661 West 4th Ave., Vancouver, B.C. V6R 1P2. American subscriptions please send \$45 in US Funds. Overseas please send \$90 Canadian (first class).

THIS IS VOLUME 7, NO. 2,  
 FEBRUARY 1994

*The Computer Paper* is published monthly by Canada Computer Paper Inc. All rights reserved. Reproduction in whole or in part without the permission of the publisher is strictly prohibited. The opinions expressed in articles are not necessarily those of the publisher.

**ADVERTISING**  
**NATIONAL AD SALES** John Oliver  
 (416) 588-1580 Toronto

**VANCOUVER OFFICE**  
**B.C. AD SALES** Dyal Singh Khalsa  
 (604) 733-5596  
**DISTRIBUTION** Ken Kemp & Co.  
**PRINTER** Transcontinental West

**TORONTO OFFICE**  
**ONTARIO AD SALES** (416) 588-1580  
 Yvette Doucette  
 Tino Wong  
 John Oliver  
 (613) 729-7306

**OTTAWA AD SALES** 1-800-465-3517  
**QUEBEC, ONTARIO & EAST**  
**ADMINISTRATION** Maureen Khalsa  
**CORPORATE DISTRIBUTION** Sangeeta Seth  
**CIRCULATION MANAGER** Charles Oliver  
**PRODUCTION** Tom Lewis  
**PRINTER** Sangeeta Seth  
 Metroland

**PRAIRIE OFFICE**  
**ALBERTA MANAGER** Patricia FitzGerald  
**MANITOBA MANAGER** Suzanne FitzGerald  
**PRODUCTION MANAGER** Tanya Bielenstein  
**AD SALES** Calgary (403) 228-3355  
 Edmonton (403) 459-3554  
 Winnipeg (204) 949-7720  
**PRINTER** Calgary Sun

**ONTARIO: 100,000 Circulation**  
 408-99 Atlantic Ave.,  
 Toronto, Ontario M6K 3J8  
 Tel: (416) 588-1580, Fax (416) 588-8574  
 BBS Number: CRS Online (416) 213-6002

**EASTERN: 75,000 Circulation**  
 National/Atlantic Sales (416) 588-1580  
 Ottawa Sales (613) 729-7306  
 Quebec, Ontario & East 1-800-465-3517

Canadian Publication Mail, Sales Product Agreement  
 #10251 Printed in Canada ISSN 1195-3454  
 Membership in the BCA Division of CCA applied  
 for September 1992.

The publisher reserves the right to refuse ads of a sexual or violent nature, or ads which may be deemed to perpetrate sexual or racial stereotypes. Specifically, ads referring to Adult Software or X-rated software will be refused. The publisher reserves the right to be the final judge of what is considered appropriate. For a copy of our full policy please contact your sales representative.

# STUDENT SPECIAL

ANUBIS

天龍電腦

\$1250

Multimedia

486 DLC-40  
 VESA M/B Local Bus  
 4 MB RAM  
 170 MB HD  
 1.44 MB Floppy Drive  
 Mitsumi CD-ROM  
 16 bit Sound Card  
 512 K SVGA Card  
 Keyboard & Mouse

PC 卡拉OK  
 中文微軟視窗  
 倚天中文系統  
 神雕筆中文手寫辨識系統  
 慧星一號中文文書系統  
 電腦軟體服務  
 電腦硬體升級

各種中文輸入法書籍：  
 倉頡輸入法  
 注音輸入法  
 廣東音輸入法  
 羅馬拼音輸入法  
 行列輸入法  
 簡易輸入法

7725 BIRCHMOUNT RD. UNIT #12  
 MARKHAM, ONT., L3R 9X3

TEL (905) 470-0365  
 FAX (905) 470-9201

## Mailbox

### 'Hacker' Or 'Cracker?'

In your Jan. '94 issue's Q & A section, the term hacker is used meaning someone who breaks into computer systems. You should have corrected the author of the question when he/she stated that this was so.

There are many definitions of what a hacker is, but there is one thing a hacker is not defined as: someone who breaks into computer systems. The term hacker was used incorrectly to denote this type of person up until the mid '80s, but you seem to have missed that period. The correct term for this type of person is a cracker.

By using the term incorrectly, you only serve to misinform the public about the type of person a hacker is.

Jeff Macht  
 jamacht@unixg.ubc.ca

**GB's reply:** I disagree with you about the meaning of the word hacker, and I'm sure that Bruce Sterling, the author of *The Hacker Crackdown: Law and Disorder on the Electronic Frontier* (Bantam Books, 1992, \$27.50) would too. It could be argued that the word cracker implies success, as in "one who cracks," while "hacker" suggests one who chops away at something — in this case, a more appropriate analogy, don't you think?

### Back Issues

I am a big fan of *The Computer Paper*. Unfor-

tunately, I only get to read the odd issue. Are back issues available on Internet, or your Mind Link BBS perhaps? Keep up the great job on *The Computer Paper* and thanks a ton.

Randy Dueck  
 Via Mind Link!

**DA replies:** No electronic version of *The Computer Paper* is available currently, though we do have plans for something in the future. In the meantime, back issues are available for a nominal fee from our offices. Contact the office nearest to you.

### More OS/2! More OS/2!!

So glad to see the recent article on Ami Pro for OS/2.

So sad to see so many people still using Windows and a marketplace controlled by a product that falls so short on delivering the power of a 486 PC.

Generally an outstanding publication. More OS/2!

Eamonn Glass  
 via Mind Link!

**DT's reply:** Check out the review of Footprint Works for OS/2 in this issue. It's an integrated application with strong individual modules. And its from a Canadian company. ■

# Ultinet's Newest Notebooks Provide VISIBLE ADVANTAGES

## Ultinet's PVT Notebook Series:

VESA local bus video and hard drive provide the advantages of high-end desktop performance in a lightweight, portable and battery-powered package.

### Features include:

- **VESA LOCAL BUS MOTHERBOARD**  
Fast direct connection between CPU, video and hard disk for enhanced video and hard disk performance — even faster than desktop models!
- **9.5" ACTIVE & PASSIVE MATRIX COLOUR LCDs / 10" PASSIVE MATRIX MONO CCFT BACKLIT**  
Simultaneous internal and external (SVGA 1024x768) display
- **TWO TYPE 2 OR ONE TYPE 3 PCMCIA SOCKETS**  
Universal IC card interface for removable network cards, flash memory drives, fax/modems, and soon to come type 3 hard drives

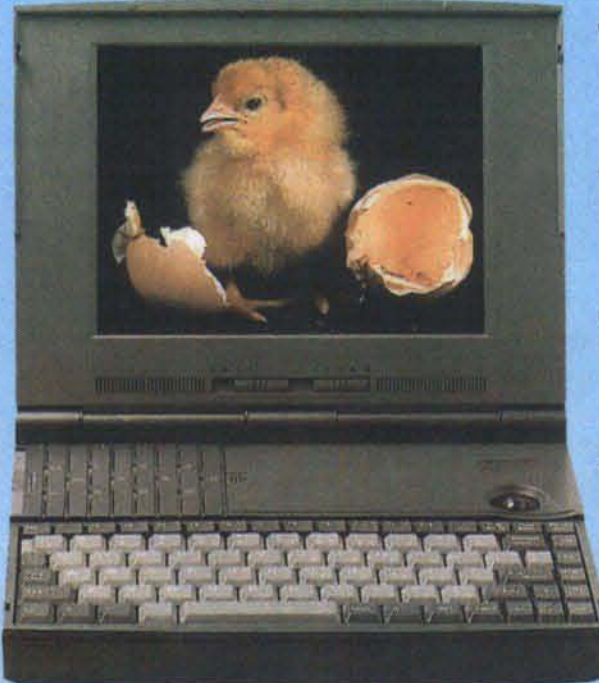

- **BUILT-IN TRACKBALL**  
Hardware-compatible with Microsoft serial mouse.  
Software-compatible with Microsoft mouse mode
- **CPU UPGRADABILITY**  
All models upgradeable from 486SX-25 to DX/2-66
- **INTELLIGENT POWER MANAGEMENT**  
Power consumption reduced, all major components go into idle mode
- **MODELS AVAILABLE**  
486SX-25. 486DX-33. 486DX/2-66

**BEST  
NOTEBOOKS  
ANYWHERE!**

| ULTINET FMT NOTEBOOKS |          |           |           |                |
|-----------------------|----------|-----------|-----------|----------------|
| Models (4 mb RAM)     | 80 mb HD | 120 mb HD | 210 mb HD | Landmark Speed |
| 386SX-25 mono         | \$1700   | \$1850    | \$2050    | 27 MHz         |
| 486SLC-33 mono        | \$1700   | \$1850    | \$2050    | 78 MHz         |
| 486SX-25 mono         | \$1800   | \$1950    | \$2150    | 83 MHz         |
| 486DX-33              | \$2100   | \$2250    | \$2450    | 112 MHz        |
| 486DX/2-66            | \$2400   | \$2550    | \$2750    | 224 MHz        |

|  |        |
|--|--------|
| Upgrade to brilliant passive matrix colour display PVT only.....                       | \$950  |
| Upgrade to brilliant dual scan passive matrix colour display for PVT & FMT models..... | \$1200 |
| Upgrade to brilliant active matrix colour display PVT only.....                        | \$2200 |
| Price/MB for add-on RAM.....   | \$80   |
| Upgrade FMT to PVT model.....  | \$300  |

### From Computing Now review...

"Ultinet brings new technologies to market as quickly as possible."  
Ultinet PVT Notebooks provide: "...up-to-the-minute features." ... "A comfortable operating environment in DOS, Windows, OS/2 or Unix." ... "video controller and IDE interface (with) VESA local bus design...this panel looks good and it's fast." ... "The keyboard is quite sturdy and has good feedback" ... "We've always liked the Ultinet products we've seen!"

While our competitors keep going bankrupt, Ultinet keeps getting stronger. Why trust companies that keep changing names and ownership? Some even claim to have been in business for many years, but have only been registered for two or three. We've been the leaders of the PC market since 1984. Ultinet was the first company in Canada to provide full high performance notebooks and VESA local bus computers. At Ultinet, we have the best desktops & notebooks.

## Ultinet Ultrapro Desktops

- Brand name processors from Intel (all 486SX, 486DX & DX2 systems)
- 1.44 mb Mitsumi/Panasonic brand Japanese hi-density floppy disk drives
- 14" SVGA .28 dp 1024 x 768 non-interlaced monitor, SVGA card with 1mb DRAM, 256 colours
- mULTI-CPU motherboard design with 240 pin PENTIUM P24T CPU socket
- 2 "VL" VESA local bus slots (upgradeable to 3 VLB slots, add \$40), 8 ISA slots
- 101-key enhanced keyboard, Microsoft-compatible mouse.
- Incredible 5 year parts & labour warranty on Ultinet's high quality VESA motherboard
- 2 year full parts and labour warranty on full system, 128k external cache
- Optional on-site warranty within major metro areas, add \$100/year per package
- Upgradeable to 486DX/2 & Pentium P24T, one of Canada's few Pentium P24T-certified systems



### ULTINET ULTRAPRO DESKTOPS

|                            |             |        |            |
|----------------------------|-------------|--------|------------|
| 486SX-25                   | 4 mb 240 hd | \$1290 | N/A        |
| 486DX-33 W/ CYRIX DLC CHIP | 4 mb 240 hd | \$1258 | ✓ N/A      |
| 486DX-33 INTEL             | 4 mb 240 hd | \$1499 | ✓ \$57/mth |
| 486DX/2-50 INTEL           | 4 mb 240 hd | \$1550 | \$59/mth   |
| 486DX-50 INTEL             | 4 mb 240 hd | \$1720 | \$65/mth   |
| 486DX/2-66 INTEL           | 4 mb 240 hd | \$1749 | ✓ \$66/mth |

**FREE WITH EVERY DESKTOP SYSTEM**  
Ultinet's VESA motherboard - Canada's best!  
2 VLB slots, mULTI-CPU, 386/486/P24T 5 year parts & labour warranty.

### VESA LOCAL BUS UPGRADES

|  | Winmark speed | Winmark speed                                  |
|--|---------------|--|
| Tseng/Cirrus 1mb, true colour, 24 bit video.....\$47 | 8M            | Diamond Viper 2mb VRAM.....\$460 ✓ 49M         |
| WD/S3 with 24 bit colour                             |               | VESA LB IDE/IO controller w/o cache.....\$30 - |
| BEST VALUE.....\$74 ✓ 18M                            |               | VESA LB hdd cache controller w/1mb.....\$260 - |
| #96XE 2mb VRAM.....\$375 ✓ 32M                       |               | ATI UltraPlus MACH 32, 2mb DRAM.....\$279 18M  |
|  |               | VESA LB hi-speed SCSI controller.....\$450 -   |

**FREE!!** Software with every system: Wordprocessor, Database, Spreadsheet, Games.

| ULTINET ULTRAPRO DESKTOP UPGRADES                       |   |
|---|---|
| Upg to 210 mb WD/SGT fast 15 ms hdd.....\$70            | Upg 14" non-int 72 Hz monitor.....\$76                  |
| Upg to 240 mb 16 ms hard drive.....\$110                | Upg 15" non-int 72 Hz monitor.....\$190                 |
| Upg 340 mb WD fast 14 ms hd.....\$189                   | Upg 17" .28 dp Flat screen monitor 1024 x 768.....\$609 |
| Upg to 440 mb Seagate hd, 15ms.....\$359                | Upg to Mitsubishi Diamond Pro 17.26 dp.....\$995        |
| Upg to 770 mb Quantum SCSI hd, 10 ms.....\$836          | Int. fax/modem 9600/2400 w/software.....\$65            |
| Upg to mid/full tower case.....\$49/80                  | Int. fax/modem 9600/14,400 w/software.....\$186         |
| Toshiba double speed CD-ROM.....\$575                   | Upg to 8/16 mb RAM.....\$240/660                        |
| Mitsumi/Panasonic double speed CD-ROM w/cntrl.....\$298 | Upg to PENTIUM 60 Mhz system.....\$1800                 |
| Soundblaster Deluxe.....\$119                           | Canon BJ10EX c/w ASF/BJ200.....\$359/410                |
| Microsoft Windows 3.1 full pkg with system.....\$55     | Panasonic 24Pin Prii KXP2023/0ki Laser 400 E \$260/690  |
| Microsoft DOS 6.0 pkg c/w disks & manuals.....\$50      |   |

We also carry a wide variety of software and hardware.

### VESA MOTHERBOARD SALE

|                               |       |
|-------------------------------|-------|
| Motherboard only (128k cache) | \$169 |
| Motherboard w/ 4mb RAM        | \$380 |
| Motherboard                   | \$140 |
| RAM (\$60/mb x 4)             | \$240 |
|                               | \$380 |

THE STANDARD OF STABILITY SINCE 1984



VAR INQUIRIES WELCOME

3200 Dufferin St., Bldg. 1B, Toronto, ON M6A 2T3

[3 blocks S. of 401, on N.W. corner of Samor and Dufferin]

Tel: (416) 256-2000 Fax: (416) 256-1449

OPEN: MON, TUES, FRI 9-6; WED, THU 9-7; SAT. 10-5

CALL OUR 24 HOUR FAXBACK LINE AT (416) 256-5779 FOR PRODUCT INFORMATION BY FAX, OR NAME OF NEAREST AUTHORIZED ULTINET DEALER

All prices based on COD, lease-to-own & credit cards. add 3%..Corporate & Government POs welcome.

# 1 STOP COMPUTER SHOP

"The Software Store With A Difference!"

## USED SOFTWARE New Titles Daily!!!

|                  |       |  |       |
|------------------|-------|--|-------|
| Gabriel Knight   | 35.00 | StarShip   | 35.00 |
| Aces Over Europe | 40.00 | Strike Commander   | 30.00 |
| Simon Sorcerer   | 35.00 | <b>*Plus too many more to list - Design &amp; Business Packages TOO!</b> |       |
| Links Courses    | 15.00 |  |       |
| Sam & Max        | 40.00 |  |       |

**Turn your software into \$\$\$  
- Ask Us How!**

New Software:

**MORTAL COMBAT - IT'S HERE!**  
**TFX - FLY IT TODAY!**  
**DOOM Shareware - \$6**

Many more Shareware Titles In-Stock!

Software Upgrades:

W.P. 6.0 DOS or Windows \$144.99  
Word Windows 6.0 \$129.99  
M.S. OFFICE \$359.99

**4 5 5 - 8 3 0 6**

239 Queen St. E., #16, Brampton  
(Under the Mandarin RestmL, On Hwy#7, W. of 410, E. of Hwy#10)  
**Drop In & Have A Coffee!**

### January Specials

- 3.5 HD Disks Pref only \$5.50
- Gravis Game Pads \$24.99
- Multi-Media Tray \$10.00
- FX2000 \$39.99
- US Robotics 14.4 Fax/Modem \$239.99

**In-Store Specials  
ALL Month!**

### Computer Mechanics

- 1Meg SIMMs \$59.99
  - 4 Meg SIMMs \$199.99
- \*Includes Installation  
Phone for pricing on Hard  
Drives, Sound Cards,  
CD-ROMs & Motherboards.  
Repair Depot located  
in Store.

### What is the Problem?

Software theft. Softlifting. Bootlegged, pirated or counterfeit software. Software rentals. Retailers loading software on computers illegally.

These are big issues for software developers, who make their living selling licenses to their software. If people are copying and using the software without paying for it, developers feel rightfully deprived of earnings from their labors.



## From the Editor

### How Big Are The Numbers?

The Software Publishers Association (SPA) in the U.S. estimates there is on the order of \$12 billion dollars worth of pirated software worldwide. They estimate that, in the U.S. alone, there is \$1.2 billion lost. One estimate translated this into the equivalent of 60,000 high paying jobs a year.

In Canada, the estimate is \$200 million lost to softlifting. Estimates range from one-in-five to one-in-three computers having illegal software on them. In some countries this figure runs past 95 percent.

Even if we question the numbers, it is obvious to anyone with a computer that a fair bit of this softlifting goes on.

### Who Softlifts?

Unscrupulous BBS operators, hackers on the Internet, shady hardware retailers, government offices, large, medium and small businesses and individual home computer users all participate in illegal software copying. In fact, on an international scale, there are entire countries that engage in the practice.

### Who's Defending Developers And With What?

On the offensive, you have large and powerful U.S. lobby groups, SPA and Business Publishers Association (BPA). In Canada, there is the Canadian Alliance Against Software Theft (CAAST), who's membership includes Bor-

land, Lotus, Microsoft, Novell, Autodesk and Quarterdeck.

The tools available to software companies trying to protect their wares are marketing and awareness campaigns, policing tactics, and lobbying efforts against countries that do not have software protection laws. (The U.S. has threatened loss of Most Favored Nation status to countries who do not respond).

In Canada, we have fairly stiff penalties for software theft. The Canadian Copyright Act was amended in 1988 to create fines of up to \$1 million and jail terms of up to five years. But these penalties are rarely, if ever, applied. The police take the view that violations are between the software company and the violator and have not as yet pressed charges in these cases.

The software companies represented by CAAST have turned to more aggressive techniques, including offering a Hot Line to turn in companies you know are using software illegally. This kind of 1-800-SQUEAL routine is used to embarrass companies into compliance. These moves rarely end up in court, but often result in hefty out-of-court settlements.

**In Canada, we have fairly stiff penalties for software theft. The Canadian Copyright Act was amended in 1988 to create fines of up to \$1 million and jail terms of up to five years.**

In Canada, CAAST has legal support for Anton Pillar action, which means that with a civil court order, CAAST can enter a business premise and seize all the computers and software as evidence. This can effectively shut down a business. Guilty or not, businesses are often willing to pay whatever is asked just to get back into business.

*Continued on page 10*

**HookUp**  
COMMUNICATIONS

# INTERNET ACCESS

## INTRODUCTORY OFFER

Receive "The Whole Internet" by Ed Krol  
**FREE with your HookUp subscription**

Rates as low as 50¢ per hour.  
**NO HIDDEN COSTS!**

Email, remote login, file transfer, news feeds.  
Local Dial-up available through the Golden Horseshoe region of Ontario. From Scarborough to Waterloo, Markham to Stoney Creek, and soon Ottawa.

**FOR INTERNET CONNECTIVITY  
CALL 1-800-363-0400**

Mention this ad to receive your FREE copy of "The Whole Internet" by Ed Krol - an invaluable Internet resource. Offer valid until March 15, 1994

1075 North Service Road West, Suite 207  
Oakville, Ontario L6M 2G2  
fax: (519) 746-3521

50 Westmount Road North, Suite 220  
Waterloo, Ontario N2L 2R5  
email: info@hookup.net

## Spend Less Without Getting Less

|   |        |
|---|--------|
| Sun Sparcstation 2 100% compatible (40Mhz, 1.44MB floppy, Ethernet, 1152x900 graphics)        | \$3999 |
| Sun Sparcstation 2+ 100% compatible (50MHz)   | \$CALL |
| Sun Sparcstation 10 100% compatible (36/40/50MHz)   | \$CALL |
| IBM RS6000 System 7011 Model 220 (16 MB RAM, Ethernet)  | \$4500 |
| IBM RS6000 System 7011 Model 22W (16 MB RAM, Ethernet, 200MB SCSI-2 Disk, Power Gt1 Graphics) | \$5925 |
| IBM RS6000 System 7011 Model 23 (16 MB RAM, Ethernet)   | \$6335 |
| IBM RS6000 System 7011 Model 23T, 23W, 340, 34W, 360, 370, 22S, 23S                           | \$CALL |

All Sun compatible stations support PC peripherals such as SVGA monitor, SCSI hard-disk, SCSI cd-rom ... Prices are subjected to be changed without notice.

**OTTAWA VALLEY TECHNOLOGIES**  
P.O. Box 78040, Nepean, ONT, K2G 3J0  
Tel/Fax: (613) 739-5577/739-2737



**Toronto:**  
287 College St.  
(416) 960-2010

**Calgary:**  
215a 6th Ave.  
(403) 261-4701

**Vancouver:**  
1445 West Broadway  
(604) 731-1088

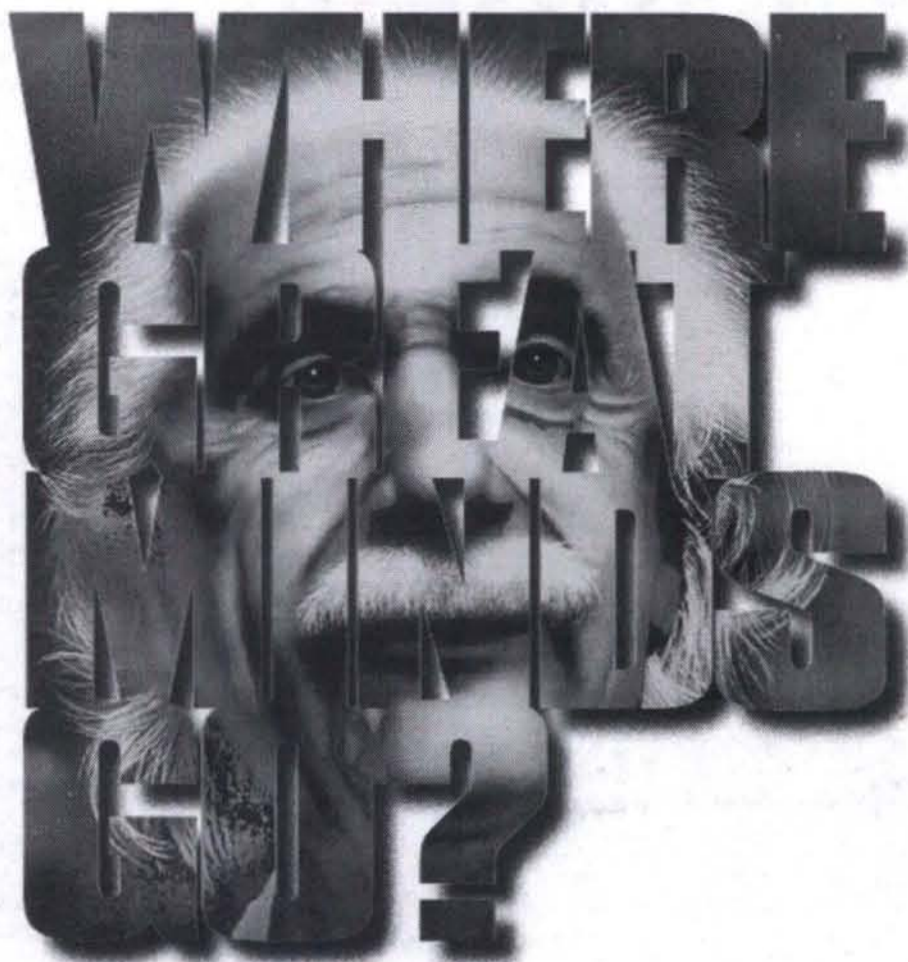

**VLB 486<sup>®</sup> DX-II 66MHz System**

**\$ 2500**

while quantities last



- INTEL 486<sup>®</sup> DX-II 66MHz CPU (256KB cache)
- VESA Local Bus Technology w/ 2 VLB Slots
- 15" Ultra VGA Non-Interlaced Monitor  
1280 x 1024 resolution, .28 dp
- ATI ULTRA PRO 32-bit VESA Local Bus Video Processor  
2 MB VRAM (20 WM)
- 245MB Hard Disk
- 4MB Fast 70ns Random Access Memory
- AmPAQ VESA Local Bus 32-bit High Performance Disk I/O Controller
- (PLUS: all standard features listed, except for having only one Floppy Drive)

**Ultimate PCI 486<sup>®</sup>DX-II 66MHz Workstation**

**\$ 3950**

while quantities last



- AmPAQ GRAPHITE 15" Ultra VGA Monitor  
15" Flat Screen Flat Square format  
76 Hz Refresh Rate Guarantees Flicker-Free Display  
Microprocessor with 13-Memory for Screen Optimization  
Low Radiation meets Swedish Authority Standard
- INTEL 486<sup>®</sup>DX-II 66MHz CPU  
Pentium Upgradeable System with INTEL ZIF Socket  
256KB 20ns Write-back System Cache Memory
- ATI PCI ULTRA PRO 32-Bit Windows Accelerator  
Mach 32 Graphics Processor & 2MB VRAM  
Non-Interlaced up to 1280 x 1024  
20% faster than its VLB version
- 525MB FUJITSU Hard Disk  
11 ms / 256KB cache
- 8MB 70ns TOSHIBA/HITACHI System Memory (128MB Max.)
- (Plus: all standard features listed)

**VLB 486<sup>®</sup>SX/245NI System**

**\$ 1550**

while quantities last



- INTEL 486<sup>®</sup>SX 33 MHz CPU (256KB cache)
- 128KB 20ns Cache Memory (0-wait-state)
- 245MB Hard Disk with Cache
- 4MB Fast 70ns System Memory
- 32-bit VESA Local Bus Video Processor 1MB RAM (20 WM)
- 14" Super VGA Screen 1024 x 768 Monitor
- 1.44MB TOSHIBA/PANASONIC High Density Floppy Drive
- (PLUS: all standard features listed, except for having only one floppy Drive)

**Standard Features:**

- AmPAQ PRO-Series Enhanced 101-key Keyboard† • 1.44MB & 1.2MB Floppy Drives
- AMPAQ PRO-Series Mini-tower / Classic Desktop Chassis† • 200Watt CSA Approved Power System
- 2 Serial, 1 Parallel & 1 Game Port • MICROSOFT DOS 6.2 (installed with software & manual)
- 3-Button Mouse† & Mouse Pad

\*Intel 386, Intel 486, Intel Inside logo are trademarks of Intel Corporation. All other trademarks are trademarks of their respective companies.  
†These components under this special promotion are different from the ones shown above. Prices subject to change without notice.  
‡Performance is rated based on Bench Mark test from Matlab.



# GLOBAL DRIVE

THE COMPUTER STORAGE EXPERTS

### HARD DRIVES

|                               |       |
|-------------------------------|-------|
| QUANTUM IDE, 270MB, 12MS      | \$335 |
| QUANTUM SCSI, 240MB, 12MS     | \$395 |
| MAXTOR IDE, 340MB, 14MS       | \$390 |
| MAXTOR SCSI, 340MB, 14MS      | \$485 |
| SEAGATE IDE, 341MB, 12MS      | \$399 |
| SEAGATE IDE, 451MB, 12MS      | \$555 |
| WESTERN DIG., IDE 340MB, 13MS | \$385 |

(LARGER CAPACITIES AVAILABLE)



**NEW LOWER PRICES**

### CONTROLLERS

|                                   |       |
|-----------------------------------|-------|
| ADAPTEC, 1542CF Kit (ISA)         | \$355 |
| ADAPTEC, 2742T KIT (EISA)         | \$525 |
| ADAPTEC, 2842T, Kit (VESA)        | \$425 |
| FUTURE DOMAIN, 1680S, 16 Bit      | \$185 |
| FUTURE DOMAIN, 850, 8Bit          | \$ 95 |
| VESA IDE Caching UP TO 1MB, Call  |       |
| VESA IDE Caching UP TO 16MB, Call |       |

### CD ROM

|                         |       |
|-------------------------|-------|
| TOSHIBA 3401B, Int.     | \$490 |
| TEXEL 5028, External    | \$545 |
| PANASONIC 562, Int.     | \$295 |
| NEC 3X, Int./Ext. SCALL |       |

**NEW**

### TAPE BACK-UPS

**IOMEGA**

250MB, Insider, 3.5/5.25 \$270

250MB, Parallel Back-up \$499 (2 Year Warranty)

**CONNER 250MB Int. Kit \$220 FREE TAPE**

250MB - 525MB, 1.3GB - 8GB SCSI BACK-UPS AVAILABLE

LOWER PRICES PROMOTIONS

# SYQUEST

## 88MB REMOVABLE DRIVES

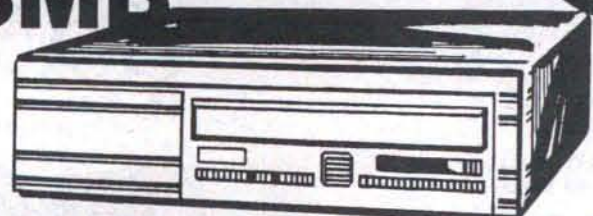

**NEW LOWER PRICES**

READ/WRITE TO 44MB AS LOW AS **\$465**

|                                     |              |
|-------------------------------------|--------------|
| 88mb R/W 44 Int. (No Cart.)         | \$465        |
| 88mb R/W 44 Ext. (No Cart.)         | \$625 PC/MAC |
| 88MB CARTRIDGE with Drive Purchase  | \$130        |
| 105MB CARTRIDGE with Drive Purchase | \$99         |

|                              |       |
|------------------------------|-------|
| 105mb Int. IDE, c/w 1 Cart.  | \$495 |
| 105mb Int. SCSI, c/w 1 Cart. | \$595 |
| 105mb Ext. SCSI, c/w 1 Cart. | \$775 |

### CARTRIDGES

syquest 44mb \$90

syquest 88MB \$140

syquest 105mb \$120

iomega 90mb \$135

iomega 150mb \$150

quantity discount on 5 or more

**IOMEGA 150MB MULTIDISK REMOVABLE DRIVES**

ALSO AVAILABLE PLEASE CALL FOR SPECIAL PRICING

**NOTE:**  
88/44 Require a Cartridge.  
PC SCSI Controllers are Extra.  
Quantities are limited.

**BLOW OUT SPECIAL**  
14ms, 256k Cache

**LOOK FOR OUR NEW LARGER LOCATION ON FEB. 1, 1994**

CHEQUES ACCEPTED



### GLOBAL DRIVE SOLUTIONS

7351 Victoria Pk., Ave. Suite 101, Markham, Ontario L3R 3A5  
 MON - WED: 9:00am-5:00pm  
 THURS. - FRI: 9:00am-7:00pm  
 SAT: 10:00am-5:00pm  
 TEL: (905) 475-1964  
 FAX: (905) 475-8102



- Worry Free Warranty
- Technical Support
- Govt & Corp. P.O.'s Accepted
- Fast Delivery
- Installation Available
- Over 10 Years of Storage Experience

Prices, availability subject to change without notice.

DUE TO CHANGING MARKET CONDITIONS PLEASE CALL FOR WEEKLY SPECIALS AND UP TO DATE PRICING. ALL PRICES CASH DISCOUNTED.

## Letter From The Editor

Continued from page 8

### Education vs Enforcement?

The issues for the software vendors boil down to questions of marketing vs policing, education vs enforcement. There are risks associated with too brutal tactics such as snitch lines and search and seizure warrants. If CAAST is perceived as being too aggressive with its policing program, it runs the risk of alienating paying customers.

The kind of protection that CAAST and the American SPA organizations are promoting tends to be a one-way street. One could easily ask: Where is the protection for buyers of bad or buggy software? Where are the software guarantees? This is not an argument for stealing software, but it is used by some to justify their actions.

### Just Lower The Prices?

Some would argue that lower software prices and consumer awareness would be much more effective than threats of enforcement. When you can buy top quality software for \$49.95, why bother stealing it?

While there is some evidence that cheaper software has an impact, many times people just want what they perceive as the best program, regardless of cost.

### What Are The Trends Now?

If the U.S. numbers are true, the problem is on the decline, but will probably never go away totally. Factors in the changing trend include: declining prices, "competitive upgrades", volume pricing from software vendors, increasing consumer awareness of what

software is and how licensing works, "network aware" applications that only allow one version of each license to run, better understanding by consumers that they are really buying a subscription to software and the value of legitimate upgrades over time, high profile prosecutions, and better laws to protect software companies internationally.

### What You Should Do If You Have Illegal Software In Your Company?

Right or wrong, CAAST's efforts are not likely to end with the recent moves against a group of Toronto BBS operators, and a business college in Victoria. To protect your business for the future, here are some suggestions if you or your company have been sampling the forbidden fruits.

- 1) Call CAAST (416-598-8988) for their brochure on how to ensure legitimacy
- 2) Conduct your own internal software audit or suggest your boss do it.
- 3) Set up policies to combat illegal copying in the future.
- 4) Set employee use guidelines to clarify that the company won't tolerate illegal software.
- 5) Look for low cost alternatives. Perhaps not everyone needs a copy of Lotus 1-2-3. Low cost integrated packages can do the job of most software for \$250 and under.
- 6) Look for shareware and freeware alternatives. Pay your shareware fees.
- 7) If you want to try out lots of software, buy a CD-ROM and order a package of time or feature demos to try out the packages you want to buy.

Douglas Alder  
Publisher/Editor

## Compusoft

Compusoft Business Systems Inc.

50 Burnhamthorpe Rd. W., Suite 401, Mississauga, Ontario L5B 3C2

### Computer Systems

|                                  |            |
|----------------------------------|------------|
| Acer A-Open 486DX-33Mhz VESA LB  | \$2,149.00 |
| Acer A-Open 486DX-50Mhz VESA LB  | \$2,359.00 |
| Acer A-Open 486DX2-66Mhz VESA LB | \$2,409.00 |
| Touch 486SLC2-66Mhz VESA LB      | \$2,049.00 |
| Touch 486DX-33Mhz VESA LB        | \$2,149.00 |
| Touch 486DX-50Mhz VESA LB        | \$2,359.00 |
| Touch 486DX2-66Mhz VESA LB       | \$2,409.00 |

**All Systems include:** 4MB Fast Ram Installed; Promise VESA LB Caching Controller W/512K; Actix S3 VESA LB Video Card W/1MB; Panasonic 1.2MB & 1.44MB Floppy Drives; Seagate ST3290A 260MB IDE Hard Drive; Acer 14" SVGA Monitor (1024X768) (28) NI; DOS 6.2, Windows 3.1; 2 Year Parts & Labour Warranty.

| IBM Valuepoint Computers       |           |
|--------------------------------|-----------|
| VP2/S 486DX-33, 4MB, 120HD     | \$1945.00 |
| VP2/D 486DX-33, 4MB, 245HD     | \$2265.00 |
| VP2/D 486DX-33, 8MB, 212HD     | \$2320.00 |
| VP2/T 486DX-33, 4MB, 340HD     | \$2275.00 |
| VP2/D 486DX2-66, 4MB, 340HD    | \$2350.00 |
| VPSI/D/R 486DX-33, 8MB, 212HD  | \$2295.00 |
| VPSI/D/R 486DX-33, 8MB, 340HD  | \$2425.00 |
| VPSI/D/R 486DX2-66, 8MB, 212HD | \$2845.00 |
| VPSI/D/R 486DX2-66, 8MB, 340HD | \$2975.00 |
| VPSI/T/R 486DX-33, 8MB, 212HD  | \$2450.00 |
| VPSI/T/R 486DX-33, 8MB, 340HD  | \$2595.00 |
| VPSI/T/R 486DX2-66, 8MB, 340HD | \$3175.00 |
| VPSI/T/R 486DX2-66, 8MB, 527HD | \$3585.00 |

| Notebook Computers             |           |
|--------------------------------|-----------|
| AcerNote 750, 4MB, 120HD       | \$2755.00 |
| AcerNote 750C, 4MB, 120HD      | \$4995.00 |
| AcerNote 750C, 4MB, 200HD      | \$5009.00 |
| IBM Thinkpad 350, 4MB, 125HD   | \$2495.00 |
| IBM Thinkpad 350, 4MB, 250HD   | \$2925.00 |
| IBM Thinkpad 350C, 4MB, 125HD  | \$3099.00 |
| IBM Thinkpad 350C, 4MB, 250HD  | \$3449.00 |
| TI 4000 486DX-25, 4MB, 120HD   | \$2799.00 |
| TI 4000 486DX-25, 4MB, 200HD   | \$3129.00 |
| TI 4000 486DX2-50, 4MB, 120HD  | \$3995.00 |
| TI 4000C 486DX2-50, 8MB, 200HD | \$5499.00 |
| Toshiba T1950CS, 4MB, 200 HD   | \$3649.00 |
| Toshiba T1950CT, 4MB, 340 HD   | \$4499.00 |

| Video Cards                         |           |
|-------------------------------------|-----------|
| Actix Graphics Engine 32 1MB (ISA)  | \$249.00  |
| Actix Graphics Engine 32 1MB (VESA) | \$249.00  |
| Actix Graphics Engine 32 2MB (ISA)  | \$329.00  |
| Actix Graphics Engine 32 2MB (VESA) | \$329.00  |
| #9 GXE LEVEL 10 1MB (ISA/VESA)      | \$399.00  |
| #9 GXE LEVEL 11 2MB (ISA/VESA)      | \$499.00  |
| #9 GXE LEVEL 12 3MB (ISA/VESA)      | \$599.00  |
| Matrox MGA II 2MB (VESA)            | \$699.00  |
| Matrox MGA II 2MB (PSI)             | \$699.00  |
| Matrox MGA Ultima 2MB (ISA)         | \$799.00  |
| Matrox MGA Ultima 2MB (VESA)        | \$799.00  |
| Matrox MGA Impression 3MB (ISA)     | \$1099.00 |
| Matrox MGA Impression 3MB (VESA)    | \$1099.00 |

**CERTIFIED NETWORK ENGINEER ON STAFF • WE SUPPORT WHAT WE SELL • OVER 10,000 PRODUCTS AVAILABLE**

Specialists in the Installation of Network Systems.

**Tel: (416) 761-1849 Fax: (416) 761-9221**

Prices are subject to change without notice. All prices are discounted for cash. All Trademarks and Registered Trademarks are of their respective companies.

Onsite Preventative Maintenance & Service Contracts Available.

# Canadian Product Launch Update

BY GRANT BUCKLER

*This regular feature summarizes announcements of new products by international companies for the Canadian market.*

(NB) — **Microsoft Canada** in Mississauga, Ont. has announced its FoxPro 2.5 database software for the Apple Macintosh computer. Its suggested retail price is \$669, but the company is offering it at the special introductory price of \$134 through June 30, 1994.

Professional Edition is scheduled to ship in February and will have a suggested retail price of \$939. Current licensees of Foxbase+ for Mac and Foxbase+ run time version can upgrade to Foxpro Professional Edition for \$399 through April 30, 1994. French and German versions are scheduled to ship in the second quarter of 1994.

Contact: Microsoft Canada, 905-568-0434

**Samsung Electronics Canada** of Mississauga, Ont. introduced its SyncMaster GL line of 14-, 15-, and 17-inch color monitors with power-saving features. The 17-inch SyncMaster 17 GL will list for \$1,399. The 14-inch and 15-inch models will ship later, at \$499 and \$699 respectively, the company said.

Contact: Samsung Canada, 416-542-3535

**Dell Computer (Canada)**, of Markham, Ont. launched the OmniPlex 560 and 566 desktop computers using Intel Corp.'s Pentium processor. Dell said the new machines, making up its second line of Pentium-based desktops, are available right away and cost \$5,119 for the 60-megahertz (MHz) OmniPlex 560 and \$5,799 for the 66-MHz OmniPlex 566.

Contact: Dell Canada, 905-764-4200

**Interleaf Canada** of Mississauga, Ont. said it is now shipping the Unix version of Interleaf 6, the new release of its document creation software.

Interleaf 6 will be available for Microsoft Windows and NT by the end of the first quarter of this year, Interleaf Canada said. The Unix version has a list price of \$2,995, with various options available at added cost.

Contact: Interleaf Canada, 905-670-5980

**Computer Associates Canada** of Mississauga, Ont., unveiled an OS/2 version of its SuperProject project management software, as well as shipping CA-Realia II Workbench, software aimed at downsizing applications.

CA Canada will sell the Windows and OS/2 versions of SuperProject together for \$649. Upgrades and competitive upgrades are \$179. For \$69, CA-SuperProject users can replace the limited version of CARealizer built into SuperProject with a full version.

CA-Realia Workbench will list for \$2,995. Users who already have Realia COBOL can upgrade to the complete Workbench for \$1,650. CA is also offering a competitive

upgrade to users of rival Micro Focus' COBOL Workbench for \$1,995.

Contact: Computer Associates Canada, 905-676-6700, fax 905-676-6734

**FaxPak**, a device that allows a computer printer to act as a plainpaper fax machine, is now available in Canada. **FaxFirst Canada**, Inc., of Toronto, is selling the unit for \$389. When in use, it sits beside a printer, receives

faxes and prints them, or stores them for later printing if the printer is not available.

FaxFirst, 416-391-2800

Continued on page 15



Now is the time to  
Trust Your Impulse®. The  
Impulse, 4 lb. REPLY® 400  
notebook computer.

- SL Enhanced i486SX/ 25MHz
- Bright 9.5" monochrome display
- 4MB RAM, removable 120MB hard drive
- PCMCIA and built-in audio
- DOS® 6.0, Windows™ 3.1

Call: 1-800-668-1111 for  
the dealer nearest you. This  
offer good while quantities last.

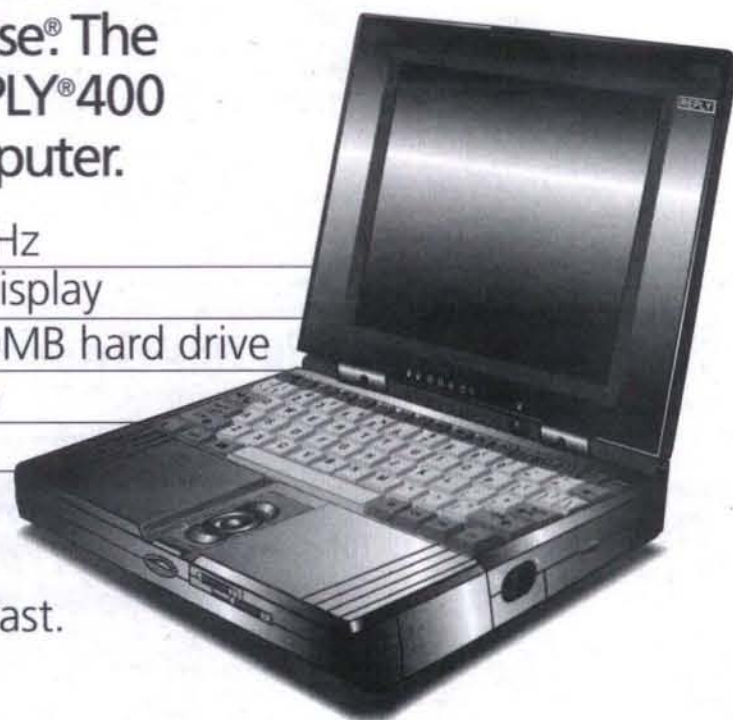

**Impulse®**  
TRUST YOUR IMPULSE

© Impulse and REPLY are registered trademarks of Canara Technologies. 2700 Argenta Road, Mississauga, Ont. L5N 5V4 Tel: 905-858-3000 Fax: 905-858-9090  
Microsoft, MS-DOS and Microsoft Windows are registered trademarks of Microsoft Corporation. Intel is a registered trademark of Intel Corporation.

SHOW REVIEW

# World of Commodore Amiga

BY GRAEME BENNETT

**New and Hot**

This year's WOC show emphasized Commodore's newest product, the CD32. Also on display was the often-discussed-but-seldom-seen MPEG "full-motion video" module. Showgoers watched as Video CDs of Top Gun and other full-length movie titles showed off the module's motion-picture expertise.

Of course, Commodore also showed its other products. Even more interesting were hints of Commodore's future product offerings and forthcoming "AAA" advanced graphics chipset by Lew Eggebrecht, VP of Engineering of Commodore International. Eggebrecht also revealed that the Tower version of the A4000 is "in the can" and would be released shortly.

Canada's own Readysoft Inc. (905-731-4175) surprised many showgoers when it revealed that its Amax IV color Macintosh emulator for the Amiga does not require the hard-to-obtain 256K Mac ROMs, but will support full color, QuickTime, System 7 and other color Mac features with the easier-to-find 128K Mac ROMs. With Amax and the ROMs, Amiga owners are able to multitask Macintosh and Amiga programs in up to 16 million colors — a sure cure for MacEnvy or the file-compatibility blues. Amax IV is available now for C\$599.95. The product requires a Zorro II slot and an Amiga with a 68020 or

greater CPU. Amax II+ owners can upgrade for C\$144.95.

At the show, Readysoft was also promising upgrades from the older cartridge-based versions of the emulator would be available in early 1994 for C\$419.95. According to the company, it will rebate cartridge owners a further \$120 if they return their old Amax cartridges.

**Graphics Galore**

Graphics products, as usual, were hot. Expert Services wowed the crowds with its Picasso II graphics board for the Amiga 2000/3000/4000. This card supports 24-bit color at resolutions of 800x600, and 8-bit color at 1280 x 1024. The Picasso board is one of the first Amiga graphics cards to support "retargetable graphics" — a phrase that I expect Amiga owners will be hearing a lot more of in the next few years. Retargetable graphics provides the ability to run system-friendly software in custom, hi-resolution, screen modes. In other words, the Picasso is likely to be more compatible with existing software titles than many other 24-bit graphics cards.

Jim Sachs, a well-known Amiga artist, gave several seminars and demonstrated Digital Creations' paint and animation software, Brilliance. A few showgoers echoed a complaint I have read and heard elsewhere: Brilliance, like Scala Multimedia 200, TVPaint and several other packages, is copy-protected with a hardware "dongle." In most cases, it seems these devices do little to thwart the concerted efforts of ace code-crackers, but instead serve primarily to inconvenience legitimate users — especially those with more than one "dongled" product.

Fargo (1-800-327-4622) showed off its Primera thermal-transfer/dye sublimation color printer with print samples from Brilliance. With street prices around US\$825, this printer sets a whole new price-point for high-quality (203-dpi) color output to paper, transparencies and even T-shirt transfers. The output from the Primera and its \$249 dye-sub "Photo-Realistic Upgrade Kit" was not quite up to pages we've seen from \$10,000 units, but nothing short of spectacular for such a low-cost printer. The Primera comes standard with drivers for Microsoft Windows and optional interfaces for Macintosh or Amiga computers.

Warm and Fuzzy Logic (804-285-4304) demonstrated Lightrave, the controversial Amiga hardware product that allows the Video Toaster's Lightwave 3D software to be used on an Amiga without a Video Toaster. Needless to say, The Toaster's developer, NewTek (1-800-847-6111), isn't too pleased. Rumors that NewTek had pulled the 3.0 Toaster software upgrade from the market in response to Lightrave have apparently proven to be false, however. (Speaking of rumors, New Media magazine reports that Wil "Wesley Crusher" Wheaton is now working for NewTek, doing 3-D animation and rendering.)

Sources claim that NewTek pulled the 3.0 software from the market only because it is preparing to offer a 3.1 software upgrade to Toaster owners. Reportedly, a pre-release copy of the Lightwave 3.1 software found itself into "Warm and Fuzzy" hands. It is said to work correctly.

Electronic Arts of San Mateo, CA, showed the newest version of its popular DeluxePaint graphics application. According to EA, an astonishing 40% of all Amiga users own one version or another of this title. In its latest incarnation, DeluxePaint IV AGA adds full support for the advanced graphics modes of Commodore's latest Amiga 4000 and 1200

models. Like the earlier non-AGA version 4.1, this release adds morphing and animation capabilities to the DeluxePaint stable of paint features.

**Sound and Music**

Amiga music buffs have reason to smile, too. After allowing DeluxeMusic to languish for several years, Electronic Arts finally released DeluxeMusic 2.0, which adds the ability to open multiple documents, ARExx support, a stand-alone Player module, and other new features.

A company called Nerveware (212-369-1733) showed RiffGrabber, an interesting US\$49 add-on for DeluxeMusic 2.0. It allows the input of MIDI data in real-time, converts it to notation, and zaps it over to DeluxeMusic 2.0 via ARExx, the Amiga's inter-application communication language. RiffGrabber can also save to SMUS (Simple Music file) for use with the original DeluxeMusic.

Elsewhere, showgoers could hear the 16-bit sound quality of the newest sound card from SunRize (408-374-4962), the Studio 16. Much of the strength of the SunRize digitizers (prices ranging from US\$595 to US\$1495) lies in their smooth integration with other Amiga products. Studio 16 effectively links an eight-track digital recording studio straight into an existing MIDI setup via Bars and Pipes (a popular Amiga MIDI software title). SMPTE support ensures that the product will coexist happily with the Amiga's many pro video products, including, of course, the Video Toaster.

**Canadian Content**

Local dealers, clubs and developers were out in force, too. AmigaMan (1-800-258-0533) knew what showgoers wanted. The company gave away copious amounts of free "I & My Amiga" calendars and attractive bumper stickers. TPUG (416-253-9637), the Toronto Pet Users Group, reminded Amiga owners that the club continues to be the best source of help and free software for all Commodore computer users.

Thunder Inovations (905-388-1818, and, yes, that's the way they spell it) is a new

*Continued on page 15*

## Multimedia CD-ROM Titles

|   |  |   |  |   |
|---|--|---|--|---|
|  <b>Better Windows Better Works</b><br>Windows utilities pack |  <b>Music Read Write Play</b><br>Music theory guide for beginners |  <b>CD-ROM Audio Tester</b><br>Audio performance checker |  <b>Brain Drain</b><br>Windows games pack |  <b>Green Environment</b><br>An introduction to environment protection |
|---|--|---|--|---|

 **Sing-n-story Time**  
 ... 5 new meaningful stories narrated by lovely children drama group  
 ... 11 songs with "Vocal Mode" and "Karaoke Mode"  
 ... 40 pages of coloring books for kids  
 ... Studio CD quality songs performed by children chorus  
 ... For age 4 to 8  
 ... Teachers and Parent's courseware included

Available from:

|          |                               |
|----------|-------------------------------|
| Toronto: | Wise Data (416) 785-4512      |
|          | Maxabyte (416) 250-8254       |
| Miss:    | Summit Soft (905) 819-9555    |
| Markham: | Maple Computer (905) 940-5507 |
|          | Acc Tech (905) 946-9440       |
| Alberta: | MicroAge (403) 875-8880       |
|          | DMA (403) 435-8888            |

**For your nearest dealer, please call:**  
**Ponlix Multimedia**  
 Tel: (416) 609-2083 Fax: (416) 609-1571  
 Distributors/Dealers' enquiries are welcome

|   |  |  |  |   |
|---|--|--|--|---|
| <br><b>1162 COLLEGE ST.</b><br>Tel. (416) 531-3698<br>Fax. (416) 531-3260<br>Toronto, Ontario<br><br><b>NEW ADDRESS</b> | <b>MOTHER BOARD</b><br>386SX-40, AMD CPU, ISA \$99<br>386DX-40, AMD CPU, 128K \$149<br>486DLC-40, 128K, CYRIX, ISA \$185<br>486DX-33, 128K, INTEL, VL-BUS \$475<br>486DX-40, 128K, AMD, VL-BUS \$475<br>486DX2-50, 128K, AMD, VL-BUS \$499<br>486SLC2-66, 128K, IBM, VL-BUS \$450<br>486DX2-66, 128K, INTEL, VL-BUS \$720<br><b>HARD DRIVE</b><br>SAMSUNG 120Mb, 17ms, 32K \$220<br>IBM 170Mb, 12ms, 96K, NEW \$265<br>MAXTOR 213Mb, 15ms, 64K \$299<br>WD CAVIAR 340Mb, 13ms, 128K \$370<br>SEAGATE 340Mb, 12ms, 256K \$395<br><b>MONITOR</b><br>DARIUS 14" SVGA INT.28 \$295<br>DARIUS 14" SVGA NON-INT \$330<br>DARIUS 14" SVGA, LOW-RAD.28 \$345<br>EVERVIEW 14" SVGA, NON-INT.28 \$310<br>AMAZING 15" SVGA NON-INT.28 \$450<br><b>VIDEO CARD</b><br>TRIDENT 512K, ISA \$50<br>TRIDENT 1MB, ISA \$85<br>CIRRIUS LOGIC 1Mb, VL-BUS \$120<br><b>KEYBOARD</b><br>MITSUMI/BTC 101-KEY \$23<br>KEYTRONIC/HONEYWELL \$45 | <b>486DLC-40Mhz/128K \$185</b><br><b>487DLC-40Mhz MATH-CO \$50</b><br><b>MICROSOFT MOUSE'93 \$35</b><br><b>SEAGATE 340Mb/12ms \$395</b><br>Prices & availability subject to change without notice - Limited quantity on some items<br><b>UPGRADE</b><br>Pick any parts, we'll install, Setup and Testing in Your system for only<br><b>\$25</b><br>FREE with any system purchase | <b>486DLC-40</b><br>Cyrix 486DLC-40Mhz, 128K Cache<br>1Mb SIMM Memory/70ns<br>120Mb IDE Hard drive<br>1.44Mb Panasonic Floppy Drive<br><b>14" SUPER VGA 0.39 Color Monitor</b><br>TRIDENT SUPERVGA 512K<br>2 Serial, 1 Parallel, 1 Game Ports<br>Mitsumi or BTC 101 Keyboard<br><b>\$925</b><br>FREE MOUSE | <b>FLOPPY DRIVE</b><br>PANASONIC 1.44Mb \$49<br>PANASONIC 1.2Mb \$59<br><b>MOUSE</b><br>LEADGEN MOUSE, 3-BUTTON \$10<br>MICROSOFT MOUSE (NEW) \$35<br><b>MISCELLANEOUS</b><br>HD/FD/CABLES & BRACKETS... \$5/ea<br>486 CPU FAN & HEATSINK \$15<br>SUPER IDE & I/O PORTS, ISA BUS \$17<br>SUPER IDE & I/O PORTS, VL-BUS \$45<br>ZOLTRIX 9600/2400 INT. \$45<br>ZOLTRIX FAX-MODEM 14.4K INT. \$195<br>WANG FAX-MODEM 14.4K EXT \$220<br>COLORADO 250Mb INT. \$239<br><b>CASE</b><br>MINI TOWER CASE, 200w \$60<br>MID-SIZE TOWER CASE, 230w \$99<br>FULL-SIZE TOWER CASE, 230w \$125<br>SUPER TOWER CASE, 250w \$199<br><b>MULTIMEDIA</b><br>CARDINAL SOUND PRO-16 \$165<br>MITSUMI CD-ROM, INT. \$220<br>MITSUMI CD-ROM, 2X, INT. \$285<br>SPEAKER w/AMP/EQ. & VOL. \$29<br>SOUND BLASTER 2.0 COMP. \$80<br>w/speaker, microphone & cables |
|---|--|--|--|---|

**\* Mon-Sat 9AM-7PM \* All prices are Cash & Carry \* Volume discount available \***

# NEC BLOWOUT

## Multi-Spin 2x

CDR-84 Internal SCSI-2  
CDR-74 External  
<280 msec average access  
300 kb/sec transfer rate  
Double seal dust proof door  
MPC Compliant  
Multisession PhotoCD



**\$369<sup>99</sup>\***  
EXTERNAL **\$449<sup>99</sup>\***

## Multi-Spin 3xi

SCSI-2 Internal TRIPLE SPEED  
<195 msec average access  
450 kb/sec transfer rate  
Double sealed dust proof door  
MPC Compliant • Multi Session Photo CD



**\$599<sup>99</sup>\***  
\*WITH PURCHASE OF CD TITLE

# WILD AND CRAZY FEBRUARY SATURDAYS

JAN 22 ONE DAY ONLY ONE DAY ONLY

**SONY** DOUBLE SPIN CDU-33A  
300 kb/sec transfer  
<320 msec avg. access

**PHILIPS** DOUBLE SPIN CM206  
350 kb/sec transfer  
<325 msec avg. access  
Manual track shuttle for Audio CD

Photo CD Multi-Session  
MPC Compliant  
XA Compliant



**\$169<sup>99</sup>\***

SAT JAN 29

**PHILIPS** CM205

**\$99<sup>99</sup>\***

MPC Compliant  
<375 msec access  
No disk caddy needed  
Manual track shuttle for Audio CD

\*purchase of 2 CD titles



**CREATIVE**  
CREATIVE LABS INC.

**Sound BLASTER**

### 16 BASIC

Panasonic IDE Interface

**\$159<sup>99</sup>\***

\*purchase of CD title

### 16 MULTI-CD

Mitsumi/Panasonic/SONY IDE Intrfc.  
Voice Recognition w/Microphone

**\$199<sup>99</sup>\***

### 16 SCSI-2

ADAPTEC SCSI-2 • EZ-SCSI  
Voice Recognition w/Microphone

**\$239<sup>99</sup>\***

**SOUND BLASTER PRO \$139.99**

## MEDIA VISION

PRO AUDIO SPECTRUM 16

"THIS IS THE BEST PC SOUNDBOARD"  
BYTE Magazine  
"FOR MY MONEY THE PAS 16 IS THE BEST DEAL GOING." PC WORLD

16 Bit Audio CD Quality  
w/Yamaha Stereo synthesizer  
20 voices • 100% compatible with Sound Blaster, Adlib, Windows 3.1, MPC

FAST SCSI Interface  
Also available with Philips/SONY IDE Interfaces

**\$199<sup>99</sup>**

Just off the boat...  
**MEDIAVISION JAZZ 16**  
16 Bit Sound w/SCSI Interface  
Philips/SONY IDE Interface available

**\$169<sup>99</sup>**

**Veridata** MHz  
**486/33**

4 MB RAM • 120 MH HDD  
SCSI-2 option available  
DAISY CHAIN UP TO 7 DEVICES WITH BUILT-IN SCSI-II PORT



**MATH CO-PROCESSOR INCLUDED**

**\$1899<sup>99</sup>**  
STARTING FROM

## TOSHIBA 17"



**MULTI SCAN MONITOR** FROM **\$799<sup>99</sup>**  
DIGITAL CONTROL

**SANYO 386sx/20** \$1199<sup>99</sup>  
2Mb RAM, 60 MB HDD

**TOSHIBA T-1900 486SX** \$2199<sup>99</sup>  
4Mb RAM, 120 MB HDD

**Paradise Accelerator for Windows** \$149<sup>99</sup>  
UP TO 31 X FASTER THAN VGA

**VIDEO SEVEN WINPRO S3-based (True Color)** \$149<sup>99</sup>

**DIAMOND VIPER VLB WEITEK 9000** FROM \$499<sup>99</sup>  
Fastest video on planet earth

**ARCHIVE** 250 MB INTERNAL TAPE BACKUP \$189<sup>99</sup>

**WangDAT 2 GB DAT** SCSI Interface  
11MB/MINUTE BACKUP & RESTORE  
**\$999<sup>99</sup>** WHILE QUANTITIES LAST

**\$1699<sup>99</sup>**

## MICROPOLIS

**1.2 GB SCSI-2 HARD DISK**  
The Mercedes of hard Drives Built like a TANK  
1.05 GB formatted **\$1099<sup>99</sup>**

1.2 GB SCSI-2 TOSHIBA..... **949.99**  
670 MB SCSI FUJITSU..... **799.99**  
510 MB IDE CONNER..... **599.99**  
410 MB SCSI-2 Hewlett-Packard ..... **499.99**  
330 MB SCSI-2 Hewlett-Packard ..... **449.99**  
345 MB IDE ..... **359.99**

## We're in bed with BIG BLUE

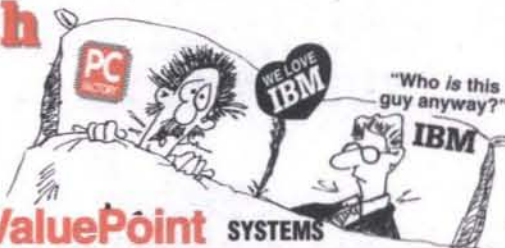
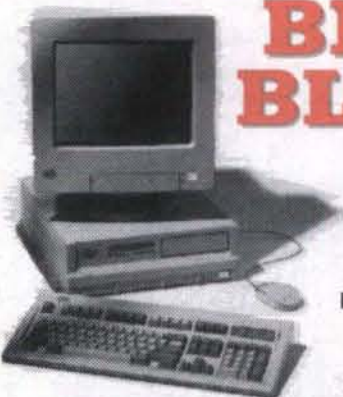

**IBM ValuePoint SYSTEMS**

**486 SX** 25MHz  
4 MB RAM  
127 MB HDD  
LOCAL BUS GRAPHICS  
**\$1149<sup>99</sup>\***  
\*monitor extra

**486 DX** 33MHz  
4 MB RAM  
212 MB HDD  
LOCAL BUS GRAPHICS  
**\$1699<sup>99</sup>\***  
\*monitor extra

**486 DX/2** 66MHz  
4 MB RAM  
245 MB HDD  
LOCAL BUS GRAPHICS  
**\$2099<sup>99</sup>\***  
\*monitor extra

### HP DESKJET 500 / Digital DecJet

**2000 INKJET PRINTER**  
360 CPS  
**\$299<sup>99</sup>\***  
\*W/ PURCHASE OF MIN SYSTEM

### PostScript Laser

HP PCL 4 • 2MB RAM  
**\$899<sup>99</sup>\***  
\*W/ PURCHASE OF IBM SYSTEM

WATERLOO



170 UNIVERSITY AVE W.  
TEL 519-746-4565 FAX 519-746-6673

TORONTO



878 YONGE STREET  
TEL 416-920-2577 FAX 416-920-0749



## BORLAND BLOWOUT

**Paradox** FOR WINDOWS  
Award-Winning Easy-to-Use Relational Data Base  
**\$79<sup>99</sup>**

**Twin Pac** FOR WINDOWS  
**\$119<sup>99</sup>**

### Borland Office

WordPerfect for Windows  
Paradox for Windows  
Quattro Pro for Windows  
**\$299<sup>99</sup>**

**FAX MODEM**  
14.4 internal 14.4 external  
from **\$169<sup>99</sup> \$199<sup>99</sup>**

# Complete Green Solution

## Express



ISO-9002 Approved



### Express for Mobility

Mobile Computing has become a way of life for people whose business takes them from one place to another. Express Micro introduces the two hottest Notebook computers this fall, a new alternative for those who want a powerful engine in a small box.

To power users, our VESA Notebook can be topped with a 486 DX2-66 engine, 20MB of memory and a massive 340MB hard drive, superior clarity of the TFT color active matrix backlit screen, with built-in trackball and versatile PCMCIA expandability - allowing you to exchange information easily with almost any environment in the world. It weighs only 6.6 lb. The heavy-duty VESA-SCSI docking station allows a full function of multimedia or multi-platform connectivity running in the home/office environment.

For light-weight users, our Sub-notebook is the first sub-notebook designed especially for mobile computing. It provides portability, ease of use, and the power of an Intel 486SX processor with up to 20MB of memory and a removable hard drive up to 120MB, all in an ultra-slim 3.9lb case. The ergonomic design and the palm rest bring a new level of comfort to the full-size keyboard. Superb VGA graphic clarity is achieved by TFT Color active matrix, Dual-scan Color or Mono B/W screen. It's small enough to fit in any brief-case, light enough to carry around, powerful enough to challenge any desktop computer, and affordable enough for business and even students.

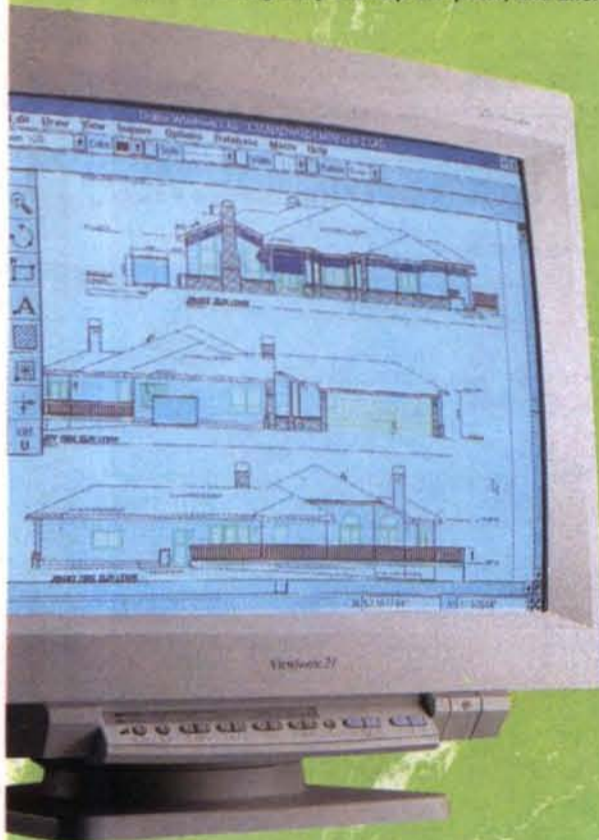

## ViewSonic®



ViewSonic, the award winning graphics monitors ranging from 14" SVGA to 21" with resolution up to 1600x1024 NI @ 0.25mm dot pitch.

All professional models of 15" or larger are certified with MPR-II low radiation, applying the latest Japanese tubes and technologies, ViewSonic offers ultra-high 76 Hz refresh rates and other benefits that give you the most value.

ViewSonic are now shipping all Green models which are VESA DPMS compliant and meet with the Energy Star Guidelines.



WINDOWS USER  
**BEST BUY!**



### Award Winning Monitors



### Express for Multimedia

Yes, we listen, we sing, and we talk back... We put the latest PC digital audio into the Express Micro system, added a video capture interface, a CD-ROM drive and a speech recognition program. Now you can enjoy photo images, movies from your VCR, audio CD's, voice messages and virtual reality...



### Express for Environment Friendly

Whether your application is casual computing or power computing, Express Micro VESA Green system uses far less energy than comparable computers. With control signal that turns the CPU, controller, hard drive motor, video device and other peripherals to 'sleep' or 'standby'. This energy-efficient designed to reduce power consumption and you can save over hundred of dollars a year.



### Express for Professionals

The new VESA Local Bus (VL-Bus) technology represents a new standard for desktop computing. Our Express Micro series includes the latest PCI, VL-Bus+EISA, VL-Bus+ISA bus architecture, even using Intel's Pentium lightning speed. Express Micro is committed to deliver high performance with the latest innovative technology.



### Express for Networking

Topping performance with the Intel DX/DX2 and Pentium processors, Express Micro systems fly with all applications in client/server platforms, as well as LAN/WAN environments.

Note that all Express Micro systems, not just the servers, are covered with a solid 3 year parts & labour warranty.

#### Authorized Dealers

##### Ontario :-

|                 |                          |                |
|-----------------|--------------------------|----------------|
| Belleville:     | P C Laser                | (613) 966-8250 |
| Carleton Place: | RKT Solutions Centre     | (613) 253-4153 |
| Cochrane:       | Video Mart               | (705) 272-3000 |
| Cornwall:       | DCS Computers            | (613) 936-1464 |
| Etobicoke:      | Accurate Micro System    | (416) 259-4111 |
| Hamilton:       | Lappert Business Systems | (905) 522-9029 |
| London:         | Xerox Computer Service   | (519) 681-1970 |
| Markham:        | Data Express             | (905) 946-9638 |
| Mississauga:    | CompuCity                | (905) 891-8368 |
| North Bay:      | Megabyte Computer Tech.  | (705) 495-3333 |
| Oshawa:         | Compute                  | (905) 433-7033 |

Peterborough: Advance Education (705) 743-7774  
SDC Computers (705) 741-0963

Scarborough: P C Discount Centre (416) 289-8630  
CompuCity (416) 289-7777

Toronto: Honson Computers (416) 967-9333

Windsor: Diazo Products (518) 974-1144

Woodbridge: Triplic Computer System (905) 850-3573

##### Manitoba :-

Brandon: Canadian Computer Era (204) 728-2417

Winnipeg: Canadian Computer Era (204) 788-4000  
Micro Mart (204) 783-8088

##### Quebec :-

Montreal: Sobeco Ernst & Young (514) 878-9090

New Brunswick :-  
Fredericton: Cadi/Cam Systems (506) 458-9766

Prince Edward Island :-  
Charlottetown: Learning Technologies Canada (902) 368-9040  
The Computer Centre (MDM) (902) 566-3919

Nova Scotia :-  
Dartmouth: Bits & Bytes (902) 466-8842  
Halifax: Kobetek System (902) 422-6556

Newfoundland :-  
Mount Pearl: Advantage Computer & Stationery (709) 747-6275

Distributed by:

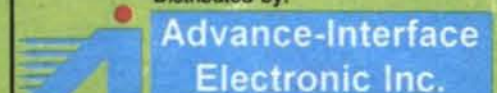

Head Office: 88 Konrad Crescent, Markham, Ontario, L3R 8T7  
Tel.: (905) 479-1443 Fax: (905) 479-1834  
West Div.: Unit 130, 4611 Viking Way, Richmond, B.C. V6V 2K9  
Tel.: (604) 270-8561 Fax: (604) 270-4953

Dealer Enquiries Welcome

All logos and products are trademarks or registered trademarks of their respective companies.

**Canadian Launch Update**

*Continued from page 11*

Apple Canada Inc., of Markham, Ontario, said it will offer processor card and logic board upgrades to add the new PowerPC microprocessor to various Macintosh models

Buyers of Macintosh Quadra 610, 650, and 950 computers will be offered a PowerPC processor card, to be delivered when the first

PowerPC Macs are introduced later this year, for about C\$150 extra. The same card will sell for about C\$750 after the new PowerPC Macs go on the market, Apple Canada said, and will work with Quadra 700, 800, and 900 systems also.

Apple also plans to provide a replacement logic board for the Macintosh Quadra 610, 650, 660AV, 800, and 840AV, Centris 610, 650, and 660AV, Ilvx, and Ilvi, as well as for the Workgroup Server 60, 80, and 95

models. To be introduced along with ready-to-run PowerPC systems in the first half of this year, the board upgrades will cost from C\$1,500 to C\$2,900, Apple Canada said.

Contact: Apple Canada, 905-513-5511

Microsoft Canada Inc., in Mississauga, Ontario, said it is now shipping its Works for Windows 3.0 integrated software and the 1994 edition of its Encarta multimedia

encyclopedia on compact disk read-only memory (CD-ROM).

Both are part of the Microsoft Home series of software. Works for Windows 3.0 has a list price of C\$269.95, but will be available for an introductory price of C\$115 until January 31, Microsoft said. Encarta has a promotional list price of C\$189.

Microsoft Canada, 905-568-0434

**World Of Commodore**

*Continued from page 12*

Commodore dealer in the Hamilton area. President Jim Gravelle says he thought the best thing about the WOC show was the renewed developer interest in Amiga products and the thriving market for third-party hardware add-ons.

Another Hamilton-based company, Asimware Innovations (905-578-4916), displayed a number of CD-ROM-related products (the company also creates custom CD-ROMs), while Quebec-based Pre-spect (514-944-9696) showed off its multi-IO cards and other Amiga hardware products.

Multi-media Mail-order Co. of London, ON (1-800-4MEDIA1) promised one-stop mail-order shopping for Amiga graphics buffs with its new catalog of multimedia products.

Of course, there isn't room to mention everything, but one thing is clear. The Amiga market, having fought back after PC and Macintosh computers threatened to steal its graphic thunder, continues to flourish. The newest wave of hardware and software add-ons ensure that there will continue to be plenty of creative work — and play — left to the Amiga. ■

Contact: Commodore, 1-800-661-AMIGA

**Largest Prime Number Found — Again!**

WASHINGTON, DC (NB) — 2<sup>859433</sup>-1 (two times two times two, 859,433 times) — that is the latest Mersenne prime number to be "discovered" by the world's supercomputers. This time, as in six out of the last seven times, a Cray computer was used, not too surprising since the company uses a primegenerating routine as a test of newly completed systems.

A Cray C90 system determined that the 258,716 digit number was a prime, during recent tests conducted at Cray Research's Egan, Minnesota offices.

There are an infinite number of prime numbers, a fact which was proven by Greek philosopher/mathematician Euclid back a few of thousand years ago. However, some observers point out that, unless a new system (algorithm) for discovering large primes is developed, these large numbers are of little interest to any but theoretical mathematicians, and actually of very little interest to them as well.

The particular method used at Cray involves squaring ever larger numbers and is thus very processor intensive - providing a good test of some major components.

Prime numbers are those such as 2, 3, 5, 7, and of course 2<sup>859433</sup>-1, which are only evenly divisible by the prime number itself and the number one. ■



**SIGNA COMPUTER SYSTEMS**  
1358 Kennedy Road, Scarborough, Ontario, M1P 2L7  
Tel. (416) 755-1590 Fax (416) 755-5950

|  |                                   |                         |                                   |                         |  |                         |                                    |                        |   |                            |                        |                            |   |                            |   |                       |                                      |                           |                        |                          |  |                          |     |                    |     |                  |     |              |    |                    |    |                  |    |                |    |                |     |
|--|-----------------------------------|-------------------------|-----------------------------------|-------------------------|--|-------------------------|------------------------------------|------------------------|---|----------------------------|------------------------|----------------------------|---|----------------------------|---|-----------------------|--------------------------------------|---------------------------|------------------------|--------------------------|--|--------------------------|-----|--------------------|-----|------------------|-----|--------------|----|--------------------|----|------------------|----|----------------|----|----------------|-----|
| <p><b>PREMIUM 386/486 SYSTEMS</b></p> <table border="1" style="width: 100%; border-collapse: collapse;"> <tr> <td>486 SX-25</td> <td>Pkg#2</td> <td>1045</td> </tr> <tr> <td>486 SX-25</td> <td>Pkg#1</td> <td>1395</td> </tr> <tr> <td>486 DX-33</td> <td>"</td> <td>1595</td> </tr> <tr> <td>486 DX2-66</td> <td>"</td> <td>1845</td> </tr> </table> <p>WARRANTY: 5 YEARS LABOUR, 2 YEARS PARTS ON COMPLETE SYSTEMS</p> <p>PKG#1 Includes: (Intel, Vesa Local Bus) 4MB Ram, 128KC, 210MB HD, 1.44 Panasonic FD, Cirrus Logic 1MB Vesa, 2 Ser/1 Par/1 Game Port, Mini-tower/Desktop case, 101 Enhanced K/B, SVGA Colour Monitor, Mouse, Dos 6</p> <p>PKG#2 Includes: 2MB Ram, 128KC, 130MB HD, 1.44 Panasonic FD, SVGA 512K, 2 Ser/1 Par/1 Game Port, Mini-tower case, 101 Enhanced K/B, SVGA Colour Monitor, Mouse</p> | 486 SX-25                         | Pkg#2                   | 1045                              | 486 SX-25               | Pkg#1                                  | 1395                    | 486 DX-33                          | "                      | 1595  | 486 DX2-66                 | "                      | 1845                       | <p><b>486 MULTIMEDIA CD SYSTEM</b></p> <p>INTEL 486 SX-25  1345</p> <p>INCLUDES:<br/>2MB Ram, 128KC, 130MB HD, 1.44 Panasonic FD, Mitsumi CD-Rom, Sound Card, 80 MB of Software, 2 Ser/1 Par/1 Game Port, SVGA 512K, Mini-tower case, 101 Enhanced K/B, SVGA Colour Monitor, Mouse, Dos 6</p>   |                            |   |                       |                                      |                           |                        |                          |  |                          |     |                    |     |                  |     |              |    |                    |    |                  |    |                |    |                |     |
| 486 SX-25  | Pkg#2                             | 1045                    |                                   |                         |  |                         |                                    |                        |   |                            |                        |                            |   |                            |   |                       |                                      |                           |                        |                          |  |                          |     |                    |     |                  |     |              |    |                    |    |                  |    |                |    |                |     |
| 486 SX-25  | Pkg#1                             | 1395                    |                                   |                         |  |                         |                                    |                        |   |                            |                        |                            |   |                            |   |                       |                                      |                           |                        |                          |  |                          |     |                    |     |                  |     |              |    |                    |    |                  |    |                |    |                |     |
| 486 DX-33  | "                                 | 1595                    |                                   |                         |  |                         |                                    |                        |   |                            |                        |                            |   |                            |   |                       |                                      |                           |                        |                          |  |                          |     |                    |     |                  |     |              |    |                    |    |                  |    |                |    |                |     |
| 486 DX2-66   | "                                 | 1845                    |                                   |                         |  |                         |                                    |                        |   |                            |                        |                            |   |                            |   |                       |                                      |                           |                        |                          |  |                          |     |                    |     |                  |     |              |    |                    |    |                  |    |                |    |                |     |
| <p><b>MULTIMEDIA</b></p> <table border="1" style="width: 100%; border-collapse: collapse;"> <tr><td>Dbl. Spd. CD/SB Pro/6 Titles</td><td>549</td></tr> <tr><td>Sound Blaster 16 Basic</td><td>189</td></tr> <tr><td>Sound Blaster Deluxe</td><td>119</td></tr> <tr><td>Wave Blaster</td><td>235</td></tr> <tr><td>Pro Audio Spectrum</td><td>235</td></tr> <tr><td>Gravis Ultra Sound</td><td>169</td></tr> <tr><td>Midi-Mate (works with PAS 16 &amp; SB)</td><td>79</td></tr> <tr><td>Win/Tv Video Capture Card</td><td>595</td></tr> <tr><td>Koss PCM/225 Multimedia Loudspeakers</td><td>109</td></tr> <tr><td>Active sp-690 speakers</td><td>59</td></tr> </table>  | Dbl. Spd. CD/SB Pro/6 Titles      | 549                     | Sound Blaster 16 Basic            | 189                     | Sound Blaster Deluxe                   | 119                     | Wave Blaster                       | 235                    | Pro Audio Spectrum  | 235                        | Gravis Ultra Sound     | 169                        | Midi-Mate (works with PAS 16 & SB)  | 79                         | Win/Tv Video Capture Card   | 595                   | Koss PCM/225 Multimedia Loudspeakers | 109                       | Active sp-690 speakers | 59                       | <p><b>LOGITECH SCANMAN</b></p> <p>256 GRAYSCALE 239<br/>colour 559</p> <p><b>ADAPTEC</b></p> <p>1522 SCSI controller 125<br/>1542C controller card 299</p> |                          |     |                    |     |                  |     |              |    |                    |    |                  |    |                |    |                |     |
| Dbl. Spd. CD/SB Pro/6 Titles   | 549                               |                         |                                   |                         |  |                         |                                    |                        |   |                            |                        |                            |   |                            |   |                       |                                      |                           |                        |                          |  |                          |     |                    |     |                  |     |              |    |                    |    |                  |    |                |    |                |     |
| Sound Blaster 16 Basic   | 189                               |                         |                                   |                         |  |                         |                                    |                        |   |                            |                        |                            |   |                            |   |                       |                                      |                           |                        |                          |  |                          |     |                    |     |                  |     |              |    |                    |    |                  |    |                |    |                |     |
| Sound Blaster Deluxe   | 119                               |                         |                                   |                         |  |                         |                                    |                        |   |                            |                        |                            |   |                            |   |                       |                                      |                           |                        |                          |  |                          |     |                    |     |                  |     |              |    |                    |    |                  |    |                |    |                |     |
| Wave Blaster   | 235                               |                         |                                   |                         |  |                         |                                    |                        |   |                            |                        |                            |   |                            |   |                       |                                      |                           |                        |                          |  |                          |     |                    |     |                  |     |              |    |                    |    |                  |    |                |    |                |     |
| Pro Audio Spectrum   | 235                               |                         |                                   |                         |  |                         |                                    |                        |   |                            |                        |                            |   |                            |   |                       |                                      |                           |                        |                          |  |                          |     |                    |     |                  |     |              |    |                    |    |                  |    |                |    |                |     |
| Gravis Ultra Sound   | 169                               |                         |                                   |                         |  |                         |                                    |                        |   |                            |                        |                            |   |                            |   |                       |                                      |                           |                        |                          |  |                          |     |                    |     |                  |     |              |    |                    |    |                  |    |                |    |                |     |
| Midi-Mate (works with PAS 16 & SB)   | 79                                |                         |                                   |                         |  |                         |                                    |                        |   |                            |                        |                            |   |                            |   |                       |                                      |                           |                        |                          |  |                          |     |                    |     |                  |     |              |    |                    |    |                  |    |                |    |                |     |
| Win/Tv Video Capture Card  | 595                               |                         |                                   |                         |  |                         |                                    |                        |   |                            |                        |                            |   |                            |   |                       |                                      |                           |                        |                          |  |                          |     |                    |     |                  |     |              |    |                    |    |                  |    |                |    |                |     |
| Koss PCM/225 Multimedia Loudspeakers   | 109                               |                         |                                   |                         |  |                         |                                    |                        |   |                            |                        |                            |   |                            |   |                       |                                      |                           |                        |                          |  |                          |     |                    |     |                  |     |              |    |                    |    |                  |    |                |    |                |     |
| Active sp-690 speakers   | 59                                |                         |                                   |                         |  |                         |                                    |                        |   |                            |                        |                            |   |                            |   |                       |                                      |                           |                        |                          |  |                          |     |                    |     |                  |     |              |    |                    |    |                  |    |                |    |                |     |
| <p><b>MONITORS</b></p> <table border="1" style="width: 100%; border-collapse: collapse;"> <tr><td>Aamazing 8489gx 14" SVGA 1024x768</td><td>*285</td></tr> <tr><td>Aamazing 8428sx 14" SVGA 1024x768</td><td>345</td></tr> <tr><td>Aamazing 8486qx 14" SVGA N.I. 1024x768</td><td>375</td></tr> <tr><td>Aamazing 15" SVGA colour 1280x1024</td><td>495</td></tr> <tr><td>Samtron 15" SVGA colour (Low emmision)</td><td>495</td></tr> <tr><td>Mag MX17 17" 1280x1024</td><td>1245</td></tr> </table>   | Aamazing 8489gx 14" SVGA 1024x768 | *285                    | Aamazing 8428sx 14" SVGA 1024x768 | 345                     | Aamazing 8486qx 14" SVGA N.I. 1024x768 | 375                     | Aamazing 15" SVGA colour 1280x1024 | 495                    | Samtron 15" SVGA colour (Low emmision)  | 495                        | Mag MX17 17" 1280x1024 | 1245                       | <p><b>CD-TITLES</b></p> <table border="1" style="width: 100%; border-collapse: collapse;"> <tr><td>7th Guest</td><td>69</td></tr> <tr><td>Return to Zork</td><td>59</td></tr> <tr><td>Comanche</td><td>99</td></tr> <tr><td>Mayo Clinic</td><td>34</td></tr> <tr><td>MPC World Atlas</td><td>29</td></tr> <tr><td>The Aanimals</td><td>34</td></tr> <tr><td>Night Owl 10</td><td>49</td></tr> <tr><td>Mavis Beacon</td><td>34</td></tr> <tr><td>Grollers Ency. 6.0</td><td>69</td></tr> <tr><td>Chessmaster 3000</td><td>29</td></tr> <tr><td>Sports Almanac</td><td>34</td></tr> <tr><td>CD Pak/Windows</td><td>139</td></tr> </table> | 7th Guest                  | 69  | Return to Zork        | 59                                   | Comanche                  | 99                     | Mayo Clinic              | 34   | MPC World Atlas          | 29  | The Aanimals       | 34  | Night Owl 10     | 49  | Mavis Beacon | 34 | Grollers Ency. 6.0 | 69 | Chessmaster 3000 | 29 | Sports Almanac | 34 | CD Pak/Windows | 139 |
| Aamazing 8489gx 14" SVGA 1024x768  | *285                              |                         |                                   |                         |  |                         |                                    |                        |   |                            |                        |                            |   |                            |   |                       |                                      |                           |                        |                          |  |                          |     |                    |     |                  |     |              |    |                    |    |                  |    |                |    |                |     |
| Aamazing 8428sx 14" SVGA 1024x768  | 345                               |                         |                                   |                         |  |                         |                                    |                        |   |                            |                        |                            |   |                            |   |                       |                                      |                           |                        |                          |  |                          |     |                    |     |                  |     |              |    |                    |    |                  |    |                |    |                |     |
| Aamazing 8486qx 14" SVGA N.I. 1024x768   | 375                               |                         |                                   |                         |  |                         |                                    |                        |   |                            |                        |                            |   |                            |   |                       |                                      |                           |                        |                          |  |                          |     |                    |     |                  |     |              |    |                    |    |                  |    |                |    |                |     |
| Aamazing 15" SVGA colour 1280x1024   | 495                               |                         |                                   |                         |  |                         |                                    |                        |   |                            |                        |                            |   |                            |   |                       |                                      |                           |                        |                          |  |                          |     |                    |     |                  |     |              |    |                    |    |                  |    |                |    |                |     |
| Samtron 15" SVGA colour (Low emmision)   | 495                               |                         |                                   |                         |  |                         |                                    |                        |   |                            |                        |                            |   |                            |   |                       |                                      |                           |                        |                          |  |                          |     |                    |     |                  |     |              |    |                    |    |                  |    |                |    |                |     |
| Mag MX17 17" 1280x1024   | 1245                              |                         |                                   |                         |  |                         |                                    |                        |   |                            |                        |                            |   |                            |   |                       |                                      |                           |                        |                          |  |                          |     |                    |     |                  |     |              |    |                    |    |                  |    |                |    |                |     |
| 7th Guest  | 69                                |                         |                                   |                         |  |                         |                                    |                        |   |                            |                        |                            |   |                            |   |                       |                                      |                           |                        |                          |  |                          |     |                    |     |                  |     |              |    |                    |    |                  |    |                |    |                |     |
| Return to Zork   | 59                                |                         |                                   |                         |  |                         |                                    |                        |   |                            |                        |                            |   |                            |   |                       |                                      |                           |                        |                          |  |                          |     |                    |     |                  |     |              |    |                    |    |                  |    |                |    |                |     |
| Comanche   | 99                                |                         |                                   |                         |  |                         |                                    |                        |   |                            |                        |                            |   |                            |   |                       |                                      |                           |                        |                          |  |                          |     |                    |     |                  |     |              |    |                    |    |                  |    |                |    |                |     |
| Mayo Clinic  | 34                                |                         |                                   |                         |  |                         |                                    |                        |   |                            |                        |                            |   |                            |   |                       |                                      |                           |                        |                          |  |                          |     |                    |     |                  |     |              |    |                    |    |                  |    |                |    |                |     |
| MPC World Atlas  | 29                                |                         |                                   |                         |  |                         |                                    |                        |   |                            |                        |                            |   |                            |   |                       |                                      |                           |                        |                          |  |                          |     |                    |     |                  |     |              |    |                    |    |                  |    |                |    |                |     |
| The Aanimals   | 34                                |                         |                                   |                         |  |                         |                                    |                        |   |                            |                        |                            |   |                            |   |                       |                                      |                           |                        |                          |  |                          |     |                    |     |                  |     |              |    |                    |    |                  |    |                |    |                |     |
| Night Owl 10   | 49                                |                         |                                   |                         |  |                         |                                    |                        |   |                            |                        |                            |   |                            |   |                       |                                      |                           |                        |                          |  |                          |     |                    |     |                  |     |              |    |                    |    |                  |    |                |    |                |     |
| Mavis Beacon   | 34                                |                         |                                   |                         |  |                         |                                    |                        |   |                            |                        |                            |   |                            |   |                       |                                      |                           |                        |                          |  |                          |     |                    |     |                  |     |              |    |                    |    |                  |    |                |    |                |     |
| Grollers Ency. 6.0   | 69                                |                         |                                   |                         |  |                         |                                    |                        |   |                            |                        |                            |   |                            |   |                       |                                      |                           |                        |                          |  |                          |     |                    |     |                  |     |              |    |                    |    |                  |    |                |    |                |     |
| Chessmaster 3000   | 29                                |                         |                                   |                         |  |                         |                                    |                        |   |                            |                        |                            |   |                            |   |                       |                                      |                           |                        |                          |  |                          |     |                    |     |                  |     |              |    |                    |    |                  |    |                |    |                |     |
| Sports Almanac   | 34                                |                         |                                   |                         |  |                         |                                    |                        |   |                            |                        |                            |   |                            |   |                       |                                      |                           |                        |                          |  |                          |     |                    |     |                  |     |              |    |                    |    |                  |    |                |    |                |     |
| CD Pak/Windows   | 139                               |                         |                                   |                         |  |                         |                                    |                        |   |                            |                        |                            |   |                            |   |                       |                                      |                           |                        |                          |  |                          |     |                    |     |                  |     |              |    |                    |    |                  |    |                |    |                |     |
| <p><b>PRINTERS</b></p> <p><b>Panasonic</b></p> <table border="1" style="width: 100%; border-collapse: collapse;"> <tr><td>1150, 9 pin, 80 col, 240 cps</td><td>189</td></tr> <tr><td>2023, 24 pin, 240 cps</td><td>259</td></tr> <tr><td>2123, 24 pin, 240 cps</td><td>319</td></tr> <tr><td>2123, 24 pin w/colour</td><td>349</td></tr> </table> <p><b>Canon</b></p> <table border="1" style="width: 100%; border-collapse: collapse;"> <tr><td>BJ-10ex w/sheet feeder</td><td>319</td></tr> <tr><td>BJ-200 w/sheet feeder</td><td>359</td></tr> <tr><td>BJC-600 colour</td><td>769</td></tr> </table>  | 1150, 9 pin, 80 col, 240 cps      | 189                     | 2023, 24 pin, 240 cps             | 259                     | 2123, 24 pin, 240 cps                  | 319                     | 2123, 24 pin w/colour              | 349                    | BJ-10ex w/sheet feeder  | 319                        | BJ-200 w/sheet feeder  | 359                        | BJC-600 colour  | 769                        | <p><b>VIDEO CARDS</b></p> <table border="1" style="width: 100%; border-collapse: collapse;"> <tr><td>Cirrus Logic 5422 ISA</td><td>99</td></tr> <tr><td>Cirrus Logic 5424 VLB</td><td>129</td></tr> <tr><td>Cirrus Logic 5428 VLB</td><td>159</td></tr> <tr><td>Western Dig. WD90C33 VLB</td><td>159</td></tr> <tr><td>ATI XL24 OEM</td><td>159</td></tr> <tr><td>ATI XL24 w/mouse</td><td>179</td></tr> </table> | Cirrus Logic 5422 ISA | 99                                   | Cirrus Logic 5424 VLB     | 129                    | Cirrus Logic 5428 VLB    | 159  | Western Dig. WD90C33 VLB | 159 | ATI XL24 OEM       | 159 | ATI XL24 w/mouse | 179 |              |    |                    |    |                  |    |                |    |                |     |
| 1150, 9 pin, 80 col, 240 cps   | 189                               |                         |                                   |                         |  |                         |                                    |                        |   |                            |                        |                            |   |                            |   |                       |                                      |                           |                        |                          |  |                          |     |                    |     |                  |     |              |    |                    |    |                  |    |                |    |                |     |
| 2023, 24 pin, 240 cps  | 259                               |                         |                                   |                         |  |                         |                                    |                        |   |                            |                        |                            |   |                            |   |                       |                                      |                           |                        |                          |  |                          |     |                    |     |                  |     |              |    |                    |    |                  |    |                |    |                |     |
| 2123, 24 pin, 240 cps  | 319                               |                         |                                   |                         |  |                         |                                    |                        |   |                            |                        |                            |   |                            |   |                       |                                      |                           |                        |                          |  |                          |     |                    |     |                  |     |              |    |                    |    |                  |    |                |    |                |     |
| 2123, 24 pin w/colour  | 349                               |                         |                                   |                         |  |                         |                                    |                        |   |                            |                        |                            |   |                            |   |                       |                                      |                           |                        |                          |  |                          |     |                    |     |                  |     |              |    |                    |    |                  |    |                |    |                |     |
| BJ-10ex w/sheet feeder   | 319                               |                         |                                   |                         |  |                         |                                    |                        |   |                            |                        |                            |   |                            |   |                       |                                      |                           |                        |                          |  |                          |     |                    |     |                  |     |              |    |                    |    |                  |    |                |    |                |     |
| BJ-200 w/sheet feeder  | 359                               |                         |                                   |                         |  |                         |                                    |                        |   |                            |                        |                            |   |                            |   |                       |                                      |                           |                        |                          |  |                          |     |                    |     |                  |     |              |    |                    |    |                  |    |                |    |                |     |
| BJC-600 colour   | 769                               |                         |                                   |                         |  |                         |                                    |                        |   |                            |                        |                            |   |                            |   |                       |                                      |                           |                        |                          |  |                          |     |                    |     |                  |     |              |    |                    |    |                  |    |                |    |                |     |
| Cirrus Logic 5422 ISA  | 99                                |                         |                                   |                         |  |                         |                                    |                        |   |                            |                        |                            |   |                            |   |                       |                                      |                           |                        |                          |  |                          |     |                    |     |                  |     |              |    |                    |    |                  |    |                |    |                |     |
| Cirrus Logic 5424 VLB  | 129                               |                         |                                   |                         |  |                         |                                    |                        |   |                            |                        |                            |   |                            |   |                       |                                      |                           |                        |                          |  |                          |     |                    |     |                  |     |              |    |                    |    |                  |    |                |    |                |     |
| Cirrus Logic 5428 VLB  | 159                               |                         |                                   |                         |  |                         |                                    |                        |   |                            |                        |                            |   |                            |   |                       |                                      |                           |                        |                          |  |                          |     |                    |     |                  |     |              |    |                    |    |                  |    |                |    |                |     |
| Western Dig. WD90C33 VLB   | 159                               |                         |                                   |                         |  |                         |                                    |                        |   |                            |                        |                            |   |                            |   |                       |                                      |                           |                        |                          |  |                          |     |                    |     |                  |     |              |    |                    |    |                  |    |                |    |                |     |
| ATI XL24 OEM   | 159                               |                         |                                   |                         |  |                         |                                    |                        |   |                            |                        |                            |   |                            |   |                       |                                      |                           |                        |                          |  |                          |     |                    |     |                  |     |              |    |                    |    |                  |    |                |    |                |     |
| ATI XL24 w/mouse   | 179                               |                         |                                   |                         |  |                         |                                    |                        |   |                            |                        |                            |   |                            |   |                       |                                      |                           |                        |                          |  |                          |     |                    |     |                  |     |              |    |                    |    |                  |    |                |    |                |     |
| <p><b>CD-ROM / TAPE B-U</b></p> <p>CD-Rom's</p> <table border="1" style="width: 100%; border-collapse: collapse;"> <tr><td>Panasonic 562 Double speed CD-Rom</td><td>299</td></tr> <tr><td>Mitsumi CD-Rom</td><td>199</td></tr> </table> <p>Tape B-U Units</p> <table border="1" style="width: 100%; border-collapse: collapse;"> <tr><td>Colorado 250MB INT. (not oem ver.)</td><td>249</td></tr> <tr><td>Colorado 250MB Tape B-U Ext.</td><td>469</td></tr> </table>   | Panasonic 562 Double speed CD-Rom | 299                     | Mitsumi CD-Rom                    | 199                     | Colorado 250MB INT. (not oem ver.)     | 249                     | Colorado 250MB Tape B-U Ext.       | 469                    | <p><b>FAX/MODEMS</b></p> <table border="1" style="width: 100%; border-collapse: collapse;"> <tr><td>US Robotics 14.4 Int./Ext.</td><td>229/245</td></tr> <tr><td>Cardinal 14.4 DSP Internal</td><td>189</td></tr> <tr><td>GVC 14.4 External</td><td>229</td></tr> <tr><td>GVC 14.4 Internal</td><td>199</td></tr> <tr><td>GVC 9600/2400 Internal</td><td>79</td></tr> <tr><td>GVC 9600/2400 Pocket F/M</td><td>139</td></tr> <tr><td>GVC 2400bps Int. Modem</td><td>49</td></tr> </table> | US Robotics 14.4 Int./Ext. | 229/245                | Cardinal 14.4 DSP Internal | 189   | GVC 14.4 External          | 229   | GVC 14.4 Internal     | 199                                  | GVC 9600/2400 Internal    | 79                     | GVC 9600/2400 Pocket F/M | 139  | GVC 2400bps Int. Modem   | 49  |                    |     |                  |     |              |    |                    |    |                  |    |                |    |                |     |
| Panasonic 562 Double speed CD-Rom  | 299                               |                         |                                   |                         |  |                         |                                    |                        |   |                            |                        |                            |   |                            |   |                       |                                      |                           |                        |                          |  |                          |     |                    |     |                  |     |              |    |                    |    |                  |    |                |    |                |     |
| Mitsumi CD-Rom   | 199                               |                         |                                   |                         |  |                         |                                    |                        |   |                            |                        |                            |   |                            |   |                       |                                      |                           |                        |                          |  |                          |     |                    |     |                  |     |              |    |                    |    |                  |    |                |    |                |     |
| Colorado 250MB INT. (not oem ver.)   | 249                               |                         |                                   |                         |  |                         |                                    |                        |   |                            |                        |                            |   |                            |   |                       |                                      |                           |                        |                          |  |                          |     |                    |     |                  |     |              |    |                    |    |                  |    |                |    |                |     |
| Colorado 250MB Tape B-U Ext.   | 469                               |                         |                                   |                         |  |                         |                                    |                        |   |                            |                        |                            |   |                            |   |                       |                                      |                           |                        |                          |  |                          |     |                    |     |                  |     |              |    |                    |    |                  |    |                |    |                |     |
| US Robotics 14.4 Int./Ext.   | 229/245                           |                         |                                   |                         |  |                         |                                    |                        |   |                            |                        |                            |   |                            |   |                       |                                      |                           |                        |                          |  |                          |     |                    |     |                  |     |              |    |                    |    |                  |    |                |    |                |     |
| Cardinal 14.4 DSP Internal   | 189                               |                         |                                   |                         |  |                         |                                    |                        |   |                            |                        |                            |   |                            |   |                       |                                      |                           |                        |                          |  |                          |     |                    |     |                  |     |              |    |                    |    |                  |    |                |    |                |     |
| GVC 14.4 External  | 229                               |                         |                                   |                         |  |                         |                                    |                        |   |                            |                        |                            |   |                            |   |                       |                                      |                           |                        |                          |  |                          |     |                    |     |                  |     |              |    |                    |    |                  |    |                |    |                |     |
| GVC 14.4 Internal  | 199                               |                         |                                   |                         |  |                         |                                    |                        |   |                            |                        |                            |   |                            |   |                       |                                      |                           |                        |                          |  |                          |     |                    |     |                  |     |              |    |                    |    |                  |    |                |    |                |     |
| GVC 9600/2400 Internal   | 79                                |                         |                                   |                         |  |                         |                                    |                        |   |                            |                        |                            |   |                            |   |                       |                                      |                           |                        |                          |  |                          |     |                    |     |                  |     |              |    |                    |    |                  |    |                |    |                |     |
| GVC 9600/2400 Pocket F/M   | 139                               |                         |                                   |                         |  |                         |                                    |                        |   |                            |                        |                            |   |                            |   |                       |                                      |                           |                        |                          |  |                          |     |                    |     |                  |     |              |    |                    |    |                  |    |                |    |                |     |
| GVC 2400bps Int. Modem   | 49                                |                         |                                   |                         |  |                         |                                    |                        |   |                            |                        |                            |   |                            |   |                       |                                      |                           |                        |                          |  |                          |     |                    |     |                  |     |              |    |                    |    |                  |    |                |    |                |     |
| <p><b>SOFTWARE</b></p> <table border="1" style="width: 100%; border-collapse: collapse;"> <tr><td>Quick Books for Windows</td><td>149</td></tr> <tr><td>Quicken for Windows/Dos</td><td>59</td></tr> <tr><td>WordPerfect 6.0 Upgrade</td><td>149</td></tr> <tr><td>Corel Draw 4.0 Upgrade</td><td>269</td></tr> <tr><td>MS Dos 6.2 Upgrade</td><td>59</td></tr> <tr><td>Borland Turbo C++</td><td>99</td></tr> <tr><td>Borland Office for Windows</td><td>319</td></tr> <tr><td>WinFax Pro 3.0</td><td>89</td></tr> <tr><td>Stacker 3.1 (Windows/Dos)</td><td>129</td></tr> <tr><td>MS Dinosaurs</td><td>59</td></tr> <tr><td>Far Side Planner Vol.III</td><td>59</td></tr> <tr><td>Norton Desktop 3.0</td><td>149</td></tr> </table>  |                                   | Quick Books for Windows | 149                               | Quicken for Windows/Dos | 59                                     | WordPerfect 6.0 Upgrade | 149                                | Corel Draw 4.0 Upgrade | 269   | MS Dos 6.2 Upgrade         | 59                     | Borland Turbo C++          | 99  | Borland Office for Windows | 319   | WinFax Pro 3.0        | 89                                   | Stacker 3.1 (Windows/Dos) | 129                    | MS Dinosaurs             | 59   | Far Side Planner Vol.III | 59  | Norton Desktop 3.0 | 149 |                  |     |              |    |                    |    |                  |    |                |    |                |     |
| Quick Books for Windows  | 149                               |                         |                                   |                         |  |                         |                                    |                        |   |                            |                        |                            |   |                            |   |                       |                                      |                           |                        |                          |  |                          |     |                    |     |                  |     |              |    |                    |    |                  |    |                |    |                |     |
| Quicken for Windows/Dos  | 59                                |                         |                                   |                         |  |                         |                                    |                        |   |                            |                        |                            |   |                            |   |                       |                                      |                           |                        |                          |  |                          |     |                    |     |                  |     |              |    |                    |    |                  |    |                |    |                |     |
| WordPerfect 6.0 Upgrade  | 149                               |                         |                                   |                         |  |                         |                                    |                        |   |                            |                        |                            |   |                            |   |                       |                                      |                           |                        |                          |  |                          |     |                    |     |                  |     |              |    |                    |    |                  |    |                |    |                |     |
| Corel Draw 4.0 Upgrade   | 269                               |                         |                                   |                         |  |                         |                                    |                        |   |                            |                        |                            |   |                            |   |                       |                                      |                           |                        |                          |  |                          |     |                    |     |                  |     |              |    |                    |    |                  |    |                |    |                |     |
| MS Dos 6.2 Upgrade   | 59                                |                         |                                   |                         |  |                         |                                    |                        |   |                            |                        |                            |   |                            |   |                       |                                      |                           |                        |                          |  |                          |     |                    |     |                  |     |              |    |                    |    |                  |    |                |    |                |     |
| Borland Turbo C++  | 99                                |                         |                                   |                         |  |                         |                                    |                        |   |                            |                        |                            |   |                            |   |                       |                                      |                           |                        |                          |  |                          |     |                    |     |                  |     |              |    |                    |    |                  |    |                |    |                |     |
| Borland Office for Windows   | 319                               |                         |                                   |                         |  |                         |                                    |                        |   |                            |                        |                            |   |                            |   |                       |                                      |                           |                        |                          |  |                          |     |                    |     |                  |     |              |    |                    |    |                  |    |                |    |                |     |
| WinFax Pro 3.0   | 89                                |                         |                                   |                         |  |                         |                                    |                        |   |                            |                        |                            |   |                            |   |                       |                                      |                           |                        |                          |  |                          |     |                    |     |                  |     |              |    |                    |    |                  |    |                |    |                |     |
| Stacker 3.1 (Windows/Dos)  | 129                               |                         |                                   |                         |  |                         |                                    |                        |   |                            |                        |                            |   |                            |   |                       |                                      |                           |                        |                          |  |                          |     |                    |     |                  |     |              |    |                    |    |                  |    |                |    |                |     |
| MS Dinosaurs   | 59                                |                         |                                   |                         |  |                         |                                    |                        |   |                            |                        |                            |   |                            |   |                       |                                      |                           |                        |                          |  |                          |     |                    |     |                  |     |              |    |                    |    |                  |    |                |    |                |     |
| Far Side Planner Vol.III   | 59                                |                         |                                   |                         |  |                         |                                    |                        |   |                            |                        |                            |   |                            |   |                       |                                      |                           |                        |                          |  |                          |     |                    |     |                  |     |              |    |                    |    |                  |    |                |    |                |     |
| Norton Desktop 3.0   | 149                               |                         |                                   |                         |  |                         |                                    |                        |   |                            |                        |                            |   |                            |   |                       |                                      |                           |                        |                          |  |                          |     |                    |     |                  |     |              |    |                    |    |                  |    |                |    |                |     |

CALL FOR ITEMS NOT LISTED

PRICES ARE SUBJECT TO CHANGE WITHOUT NOTICE. ALL PRICES ARE CASH DISCOUNTED.

## FEATURE

# Basic Sound Cards For The PC

BY PHILIP MOORE

You've all heard the hype and seen the ads. You know a sound card can add spectacular sounds and music to your games, multimedia efforts, or even to Windows. Installing a sound card in your PC has become almost as commonplace as owning a VGA video card. It won't be long before they are bundled with all new PCs as a matter of course. If you are in the market for a sound card, though, it can be confusing deciding which to buy — there are just so many around now and they all seem to have features others lack.

This roundup of sound cards attempts to help you make your choice.

## Adlib

It's unlikely you will find the Adlib being sold any more, but I include it for historical reference. The Adlib was the first sound card on the PC and introduced the almost universal standard of FM synthesis. It was mono, had no digital audio capabilities, but took the PC games world by storm.

After its release, Adlib was rather slack in developing the card further and was overtaken by rival compatible cards — notably the SoundBlaster.

## Creative Labs SoundBlaster

This is the card everyone knows about — due more to sharp marketing and continued development than anything else.

The original SoundBlaster was basically an Adlib clone, offering mono FM synthesis, with the added bonus of digital audio (also mono only).

Game makers quickly saw the advantages of the digital audio section, and their support has helped make the card and its descendant models the most popular sound card in the world.

## SoundBlaster (Deluxe)

The SoundBlaster (Deluxe) is actually the original SoundBlaster card (V.2) repackaged. This is a very straightforward card for the budget-conscious. It uses the same mono FM synthesis chips as the original Adlib, and offers up to 11 simultaneous musical voices. (This means you can have as many as 11 notes playing at once, and it doesn't matter what instrument sound is playing any of these notes).

The Digital Audio is minimalist compared to some of the higher-end cards, but perfectly adequate for games. It will record wave audio in 8-bit from only 4 to 15 KHz sample rate in mono. Playback can handle sample rates up to 44 KHz (8-bit, mono).

A suite of software comes bundled with the card. In the Windows domain you get Creative Wave Studio, a Wave editor replacing the origi-

nal VEDIT of earlier versions. This is a good program, with some effects like Reverse and Echo, though the lack of an Undo function limits it.

You also get Soundo'LE, a recorder which is not much different from the Sound Recorder already in Windows; Mosaic, a puzzle game with sound effects; JukeBox for playing MIDI files; Talking Scheduler, an interesting diary-like application with appointments being announced verbally by a choice of characters; and Monologue, a text-to-speech converter which allows you to highlight text and have it read out through the sound card in an almost human voice. You can also define phonetic pronunciation for individual words using the dictionary utility

— very clever.

Some people complained about the lack of Windows software with earlier releases. That problem has certainly been addressed. One could argue as to the usefulness of some of the software, but there's no denying there's plenty of it.

For DOS users there is the FM Intelligent Organ, a DOS jukebox for music files; SBTalker, a command line text-to-speech converter, which is great for use in batch files; Dr. Sbaits, a kind of talking on-line psychiatrist; and the ever popular Talking Parrot, which mimics what you say into the microphone and laughs if you touch the keyboard. All interesting stuff, in a gimmicky sort of way.

As well, there is a range of DOS utilities for converting between Creative Labs VOC format files and WAV files; command line players for both CMF and MIDI music files; and MMPlay, a multimedia script player that allows you to combine sound files with Autodesk Animator Pro FLI files.

If you just want a sound card that will work with most games, and that gives plenty of bundled software to play around with, then the Deluxe version of the SoundBlaster is a good buy.

## SoundBlaster Pro

This sound card was released over two years ago and was seen as a major improvement over the original SB. The FM synthesis was made stereo, and the digital audio recording now goes as high as 44.1 KHz in 8-bit mono, or 22.05 KHz/8 bit stereo. (There are, in fact, three versions of the

*Continued on page 18*

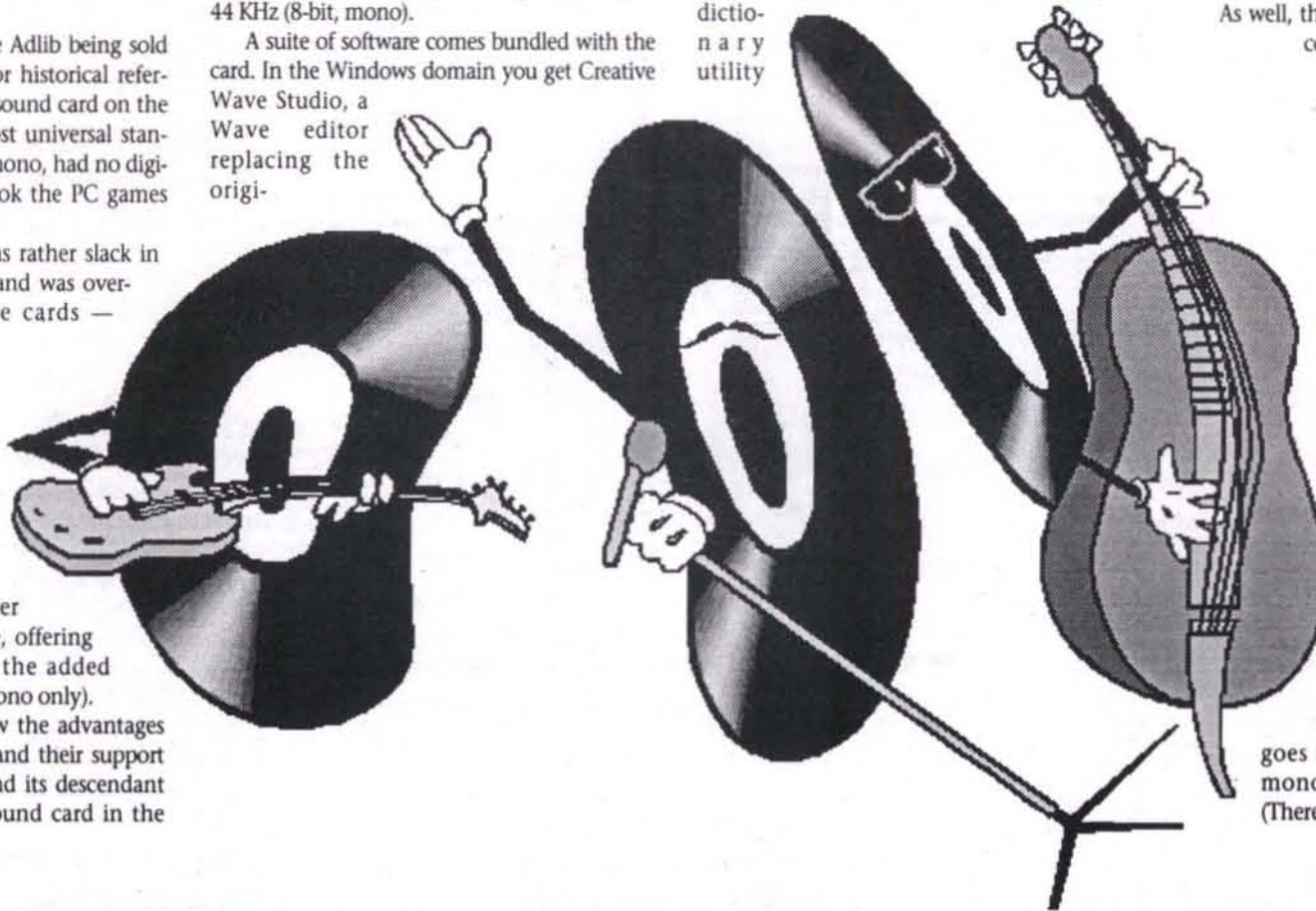

# The best thing going.

# EUROCOM®

For the world's most powerful super-notebooks,  
call an authorized EUROCOM dealer or EuroPak International,  
148 Colonnade Road, Ottawa (613) 224-6122 or fax (613) 722-2767.



# ACCESS Business Centre

...your access to office technology

| OLIVETTI<br>PHILOS 44   | ZENITH<br>Z-STAR 33Mhz  | NOTEBOOKS   | ZENITH<br>Z-NOTE+ 33Mhz  | CANON<br>NOTEJET 486   |
|---|---|---|--|--|
| i486 SL-33 (DX)<br>Dictaphone<br>Numeric Keypad<br>Removable Media<br>Mono or Active Colour | 486-SLC 33<br>200mb Disk<br>J-Key Mouse<br>PCMCIA Slot<br>Mono or Dual-scan<br>Passive Colour | <b>IBM<br/>PS-NOTE 425</b><br>486 SLC-25<br>Fax/Modem<br>Touch Mouse<br>Colour/Mono | i486 SL-33 (DX)<br>209mb Disk<br>Built in Ethernet<br>Windows for Workgroups<br>Available in Mono,<br>Dual-Scan or Active Colour | 486 SLC-25<br>2 PCMCIA Slots<br>Hand-Held Trackball<br><b>BUILT IN BUBBLE JET<br/>PRINTER!</b> |
| <b>\$2649<sub>mono</sub></b>  | <b>\$2599<sub>mono</sub></b>  | <b>\$2795<sub>mono</sub></b>  | <b>\$3295<sub>mono</sub></b>   | <b>\$3595<sub>mono</sub></b>   |

CALL US! A COMPLETE LINE OF BRANDNAME NOTEBOOKS ARE AVAILABLE

### BUSINESS ACCOUNTING

|                         |          |
|-------------------------|----------|
| Business Vision II      | \$129.99 |
| Business Vision II+2    | \$599.99 |
| Business Vision Turbo   | \$949.99 |
| Business Vision Delta   | \$ CALL  |
| CA- Simply Accounting   | \$ CALL  |
| CA- ACCPAC PLUS Series  | \$ CALL  |
| CA- BPI II              | \$199.99 |
| M.Y.O.B. Win            | \$129.99 |
| Quick Books             | \$179.99 |
| Dac Easy                | \$179.99 |
| Peachtree R2 Windows    | \$199.99 |
| Peachtree Complete V. 7 | \$329.99 |

To computerize your Business Accounting we offer a full range of computers and services

- Assistance in choosing the right software
- Service to setup accounting on your computer
- Supply, installation and maintenance of custom accounting systems
- Pre-packaged accounting computer systems
- Training on use of the software

| IMAGINATION SYSTEM   | PS/1 MULTIMEDIA  |
|--|--|
| 486sx 25mhz<br>129mb Disk<br>4mb Ram<br>14" SVGA monitor<br>2400Bd Modem<br>LOCAL BUS!<br>Disney Sound Source<br>11 Software Titles! | 4mb / 170mb<br>Sound Blaster 16<br>Local Bus Video<br>Double Speed CD Rom<br>7 CD Titles<br>Built in Modem<br>Speakers |
| <b>\$1899.</b>   | <b>\$2449.</b>   |

CALL US! COMPLETE LINE OF PS/1 SYSTEMS AVAILABLE

| LANTASTIC STARTER KIT   | NETWORKING  | D-LINK NETWORK HARDWARE  |
|---|---|--|
| - Networking Software<br>- 2 Ethernet Cards<br>- Cabling, Terminators<br>- Complete package to network 2 computers! | - CUSTOM TAILORED NETWORK SOLUTIONS<br>- SYSTEM AND CABLE INSTALLATION<br>- 14 YEARS EXPERIENCE<br>- FULL SUPPORT AND SERVICE<br>- WE TAKE CARE OF ALL YOUR NEEDS | DE-220T 16 BIT ETHERNET CARD \$CALL<br>- Software Configurable<br>- 5 year warranty  |
| <b>\$499.</b>   | NOVELL NETWORK PRICING -- \$CALL  | ETHERNET PKG. \$CALL<br>- 12 port DE812 Concentrator<br>- 12 DE-220T Ethernet Cards<br>- Peer to Peer Software<br>PCMCIA ETHERNET CARD \$389 |

### SUPPLIES

| INK CARTRIDGES   | TONERS  |
|--|---|
| BC-01 32.95<br>BC-02 34.95<br>BJI642 34.95<br>BJI643 Black 34.95<br>BJI643 Colour 44.95<br>BJI201 Black 10.95<br>BJI201 Colour 11.95<br>HP 1200C Blk 38.95<br>HP 1200C Clr 43.95 | New Rec.<br>For HP II,III 95.00 69.00<br>For HP IIP,IIIP 79.00 59.00<br>For HP IV 139.00 99.00<br>For HP IIIsi 159.00 129.00<br>For HP IV-L/P 89.00 N/A |

\*\$30 Rebate on empties

| COPIER AND FAX   |
|--|
| New Rec.<br>A-15 119.00 89.00*<br>A-30 149.00 99.00*<br>PC-20 129.00 69.00<br>FX-1 129.00 99.00* |

| INK REFILLS  |
|--|
| Canon (Black) Pkg/2<br>5,10ex, 20, 200 29.95<br>300,330 29.95<br>Canon (Colour) Pkg/2<br>5, 10ex, 20 200 39.95<br>Blue, Red, Green, Brown & Violet<br>Deskjet Black Pkg/2<br>High Capacity 29.95 |

| LEXMARK 4039-10R   | LASER PRINTERS  | LEXMARK 4037-5E  | BROTHER HL-6  | Canon LBP 430   |
|--|---|--|---|---|
| LASERJET IV 600DPI<br><b>\$1999.</b><br>Winjet 800 \$999<br>Winjet 1200 \$1195 | 10 Pages Per Minute<br>Postscript and PCL 5<br>True 600 DPI<br>2 Megs /exp to 64mb<br>Smart Switching<br><b>\$1999.</b> | 600 DPI 250 PG tray<br>4 PPM Power Saver<br>PCL 5 45 Fonts<br>2MB Ram<br><b>\$1399</b> | 6 Pages per min.<br>48 Resident Fonts<br>Auto Switching<br>Power Saver Mode<br>Postscript option<br><b>\$799.</b> | 300 DPI 10Mhz Proc.<br>5 PPM 150 Sheet Tray<br>PCL 4 EPA Certified<br><b>\$999.</b> |

CALL US! OTHER LASER PRINTERS AVAILABLE - 11X17, 1200 DPI ETC.

| MICROTEK ScanMaker  | SCANNERS   | NISCAN PORTABLE   | star SJ-144  | COLOUR PRINTERS  |
|---|--|---|--|--|
| - Up to 1200dpi<br>- Up to 8.5" x 14"<br>- Fully TWAIN comp.<br>- Colour, Grey or B&W<br>- Up to 16.7m colours<br>- PC/MAC compat.<br>Bundled with Photoshop LE<br><b>\$1195.</b> | Scans to legal size<br>Twain Compatible<br>Fax and Photocopy<br>256 Greyscale<br>400 Dots Per Inch<br>Battery/AC Power<br>No Interface Req'd<br>Runs from Printer Port<br>With OCR & Imaging Software<br><b>\$899.</b> | Full Colour Heat Fusion<br>Hi-Res 360 DPI<br>15 TrueType fonts<br>Star NX-1040 9 pin<br>Colour Dot Matrix \$249<br>Star NX-2420 24 pin<br>Colour Dot Matrix \$399 | Desktop colour printer<br>Full Colour Heat Fusion<br>Hi-Res 360 DPI<br>15 TrueType fonts<br>Star NX-1040 9 pin<br>Colour Dot Matrix \$249<br>Star NX-2420 24 pin<br>Colour Dot Matrix \$399<br><b>\$699.</b> | NEW! Canon BJC - 600<br>COLOUR BUBBLEJET PRINTER<br>Plain Paper<br>360 dpi<br>100 sheet feeder<br>3 emulations<br>Fast printing<br><b>\$CALL</b> |

### LEXMARK

360 Dots per inch  
11x17 paper size  
16.8 Million Colours  
True Postscript  
PC, MAC, OS/2

**\$3195**

### CUSTOM SYSTEMS

Home & Office  
Graphics  
Networks  
Specialized Applications  
Manufacturing

**BusinessVision**  
The Business Management & Accounting System  
FULLY INTEGRATED  
ON-LINE REAL TIME ACCOUNTING

### SERVICE

- On site and depot service
- Custom tailored service programs
- Authorized warranty repairs for Canon
- Committed to providing superior service at competitive prices

### BUBBLEJET PRINTER

|  |                                |                                |
|--|--------------------------------|--------------------------------|
| Mac/IBM<br><b>BROTHER HJ-400</b><br><b>\$389</b> | <b>BJ-200</b><br><b>\$CALL</b> | <b>BJ-10SX</b><br><b>\$329</b> |
|--|--------------------------------|--------------------------------|

sure this is the one you get, as the quality of the FM music may be much better because a different chipset — the 4 operator OPL3 — is used).

For some games the SB Pro will make a marked difference in the sound quality. It offers full stereo music and effects, and the FM synthesizer is now capable of 20-voice polyphony in stereo. For Windows multimedia, the SB Pro is also a more viable choice because it comes with a CD-ROM interface. Until recently this used the Matsushita/Panasonic standard, which would only work with the CD-ROM supplied by Creative Labs. These drives are good, but there are certainly faster ones around. You can now get the SB Pro with a SCSI or Sony 31A CD-ROM interface as well. As a rule, SCSI is the best way to go as it will work with any SCSI drive and operates at faster speeds.

The card has sockets for Line-in, Microphone in, and Line-out. You can also buy a MIDI breakout box separately. This connects to the joystick port and allows you to attach a MIDI keyboard to the SoundBlaster for MIDI recording.

The software is identical to that supplied with the Deluxe, with a couple of additions. HSC Interactive is a Windows multimedia authoring package. It is very well presented and easy to use. You just place icons on the page in a tree-like structure to create a linear presentation. You can play WAV, MIDI and CD-Audio files using standard Windows MCI commands, and visuals can be handled by Microsoft Video clips or ANI animations.

The only real drawback I found was that the card does not import animations from any package apart from its own proprietary one. Autodesk FLI and FLC files are considered a standard for this sort of work these days, and should have been included.

A CD-ROM disk of Software Toolworks' Encyclopedia is also included. This is included whether you buy a CD-ROM or not and is meant as an inducement to get one. I can vouch for its being an excellent reference tool.

The SoundBlaster Pro is also a good choice for gamers and multimedia developers. There is also a Microchannel version available for those with an IBM PS/2 machine.

**SoundBlaster 16 & WaveBlaster**

The latest offering from Creative Labs is the SB-16, and much has been made of its 16-bit capabilities. This refers to the fact that the Digital Audio section of the card can now sample and play back WAV files at 16-bit as well as 8-bit resolution, at sample rates of up to 44.1 KHz in stereo. This is CD quality and very professional for what is still essentially a domestic market card.

There are actually two versions of this card — the SB-16 and the SB-16 ASP. The ASP stands for Advanced Signal Processing, which comes in the form of an additional chip on the card to handle some of the digital processing. Part of this is the use of DMA (Direct Memory Access) to process the incredible amount of data in 16-bit sound files.

The digital audio in the SB-16 is excellent, though it must be said that if you are only interested in playing games, no game in the near future is likely to support 16-bit sound except perhaps some CD-ROM titles. If, however, you intend to make your own quality recordings, or to record from audio CDs from the CD-ROM drive, 16-bit sound is the way to go.

As far as the FM synthesizer goes, it is no different to the SB Pro. Good, but still FM. In an attempt to upgrade the card while maintaining

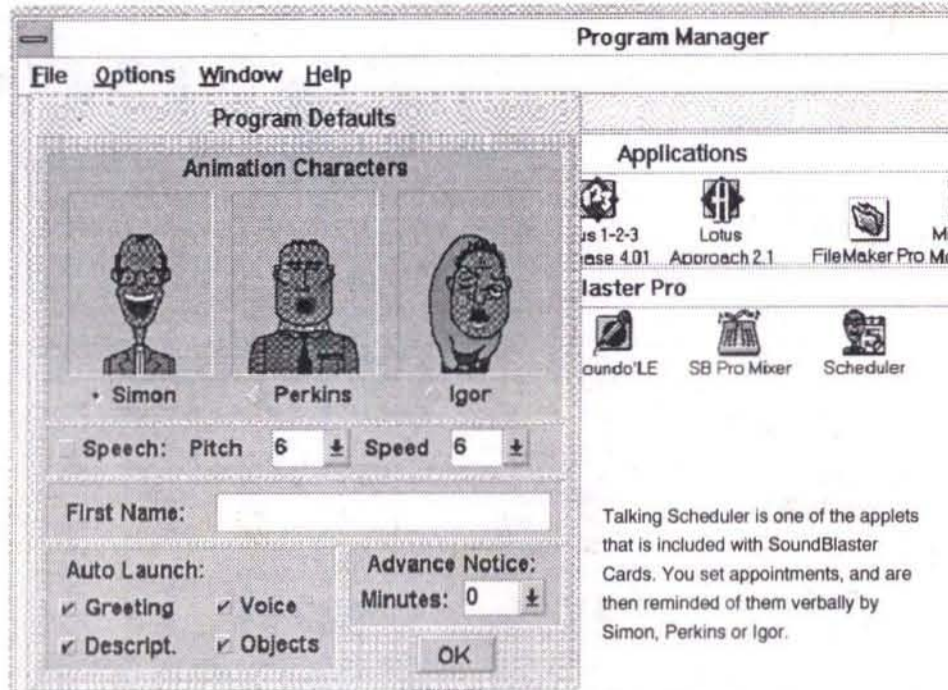

downward compatibility, Creative Labs has added an option for a daughterboard called the WaveBlaster, which uses an industry-standard MPU-401 MIDI interface.

The WaveBlaster is a complete extra sound card that clips onto the SB-16. It is, in fact, an Emu Proteus/1XR synthesizer on a card and conforms to General MIDI. The Proteus, though considered old technology in professional music circles, nonetheless provides sound far superior to the FM of earlier cards. It uses samples of real instruments, so a piano will actually sound like a piano.

With a WaveBlaster board attached you have two separate sound devices to choose from. Under Windows there are two drivers in

the control panel (FM and MIDI), and most DOS games should work with the WaveBlaster if you select either MT-32 or General MIDI options (though you may not get the correct instrument sounds). Creative Labs have bought out Emu Systems, so expect to see more SoundBlaster products using this technology in the future.

Software-wise, the SB-16s come with exactly the same suite of applications as their lesser brothers, plus: PC Animate, the animation program that accompanies HSC Interactive; and Voice Assist, a speech recognition program for Windows. This allows you to give your computer verbal commands via a microphone and

Continued on page 20

**TIME**

COMPUTER PRODUCTS



Authorized Canadian Reseller  
Authorized Upgrade Reseller  
Authorized Educational Reseller

**19,400 Products Available from One Location**

COMPUTERS, PRINTERS, MONITORS, SOFTWARE AND ACCESSORIES



**BEFORE YOU BUY A CLONE.**

**TEST DRIVE OUR AFFORDABLE BRAND NAMES.**

|  |         |
|--|---------|
| <b>IBM PS ValuePoint SI</b>  |         |
| 486 SX/25 with 4 MB RAM, 120 MB Disk, 14" SVGA Monitor, Mouse, DOS & Windows   | \$1,599 |
| 486 DX/33 with 4 MB RAM, 212 MB Disk, 14" SVGA Monitor, Mouse, DOS & Windows   | 2,115   |
| 486 DX2/50 with 4 MB RAM, 212 MB Disk, 14" SVGA Monitor, Mouse, DOS & Windows  | 2,529   |
| <b>COMPAQ Presario</b>   |         |
| 486 SX/25 with 4 MB RAM, 200 MB Disk, 14" SVGA Monitor, Mouse, DOS & Windows   | \$1,699 |
| 486 SX/33 with 4 MB RAM, 200 MB Disk, 14" SVGA Monitor, Mouse, DOS & Windows   | 1,915   |
| 486 DX2/50 with 4 MB RAM, 270 MB Disk, 14" SVGA Monitor, Mouse, DOS & Windows  | 2,489   |
| 486 DX2/66 with 4 MB RAM, 340 MB Disk, 14" SVGA Monitor, Mouse, DOS & Windows  | 3,085   |
| <b>AMBRA Achiever</b>  |         |
| 486 SLC2/50 with 4 MB RAM, 170 MB Disk, 14" SVGA Monitor, Mouse, DOS & Windows | \$1,889 |
| 486 DX/33 with 4 MB RAM, 170 MB Disk, 14" SVGA Monitor, Mouse, DOS & Windows   | 2,075   |
| 486 DX2/66 with 4 MB RAM, 240 MB Disk, 14" SVGA Monitor, Mouse, DOS & Windows  | 2,875   |

TAKE ONE HOME WITH A

**20%** DOWN PAYMENT O.A.C.

3 years parts & labour warranty across Canada.

First year On-Site service at your home or office.

7 days a week, 24 hours a day technical support.

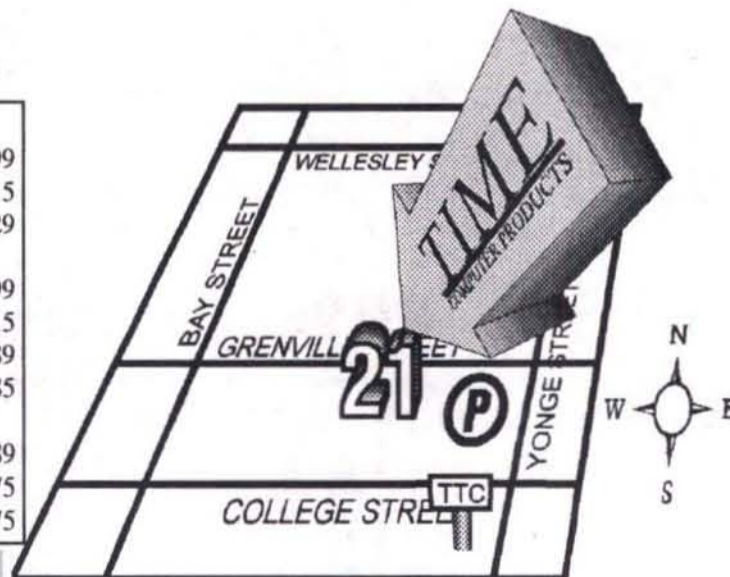

Store Hours: 9:00 am to 7:30 pm Monday thru Friday  
10:00 am to 6:00 pm Saturday

**416-920-2220**

CALL FOR A FREE CATALOGUE

AUTHORIZED RESELLER **IBM HEWLETT-PACKARD** AUTHORIZED RESELLER  
**HARDWARE - SOFTWARE - ACCESSORIES - BOOKS - SERVICE**

# ONE STOP SHOPPING WAREHOUSE

**INTEL 486SX-25 Mhz 256K**

**MULTIMEDIA VESA SYSTEM**

- MID Tower Case
- 4M Ram, 101 KB
- Pan. 1.44M FD
- 270M HD/Cache
- VESA SVGA & I/O Card
- Pan 562 CD ROM
- 14" SVGA N.I. Mon .28
- Sound Blaster 16
- Spkrs CP-55, Mouse
- Grolier MM Ency & 4 More Titles
- Dos 6.2, Win 3.1 & Multimedia Pk

Lease Rate \$71.64\*

FREE Headphone Microphone

**\$1999**

**486 DX-33**

**\$2219**

**Parts & Service Department**

**MAINBOARD**

|                              |          |
|------------------------------|----------|
| 486DX 128K                   | \$109.95 |
| 486DX 256K                   | \$124.95 |
| 486DX 256K (P24T Upg. GREEN) | \$139.95 |
| INTEL 486 256K (SCSI, PCI)   | \$354.95 |
| OPTI 512K (Pentium, VESA)    | \$564.95 |
| INTEL 256K (Pentium, PCI)    | \$649.95 |

**INTEL CPU**

|            |      |
|------------|------|
| 486 SX-25  | CALL |
| 486 SX-33  | CALL |
| 486 DX-33  | CALL |
| 486 DX2-50 | CALL |
| 486 DX-50  | CALL |
| 486 DX2-66 | CALL |
| PENTIUM 60 | CALL |

**I/O CONTROLLER**

|                                 |          |
|---------------------------------|----------|
| UMC IDE HD/FD (2S/P/G)          | \$19.95  |
| UMC IDE HD/FD (2S/P/G) LB       | \$24.95  |
| VISTA IDE HD/FD 64K (2S/P/G) LB | \$104.95 |

**VIDEO CARD**

|                            |          |
|----------------------------|----------|
| TRIDENT 9000 512K          | \$59.95  |
| TRIDENT 8900D 1M           | \$84.95  |
| CL 5428 LB 1-2M            | \$124.95 |
| WD 90C33 LB 1-2M (Pentium) | \$129.95 |
| S3 86C805 LB 1-2M (PCI)    | \$249.95 |

**FLOPPY & HARD DRIVES**

|                |          |
|----------------|----------|
| Panasonic 1.2  | \$59.95  |
| Panasonic 1.44 | \$49.95  |
| Quantum 270M   | \$324.95 |
| Quantum 340M   | \$374.95 |
| Seagate 214M   | \$279.95 |
| Seagate 260M   | \$299.95 |
| Seagate 341M   | \$399.95 |

**We Specialized in UPGRADE & REPAIR On All IBM and Most IBM Compatibles.**

**All Systems Are CSA Approved Guarantee 48 hrs Burn-in & Tested 2 Yrs Parts & Labour Warranty**

**INTEL 486DX-33 Mhz 256K**

**POWER VESA SYSTEM**

- MID Tower Case
- 340M HD w/Cache
- Pan. 1.44 & 1.2M FD
- 8M Ram
- VESA LB IDE Controller
- VESA LB Video 1M Card
- 14" SVGA N.I. Mon .28
- Keytronic 101 KB
- DOS 6.2 & Mouse

Lease Rate \$72.36\*

**\$2019**

**486 DX2-66**

**\$2299**

**CD ROM BUNDLE**

**TOSHIBA 3401**

LaswerWAVE 16  
 Grolier MM Ency. 6.0  
 Audubon Mammals Sound Library  
 4 Micropose Games  
 CP-55 Speakers  
 Headphone Microphone

**\$749.95**

**CD ROM BUNDLE**

**PANASONIC 562**

AudioWAVE 16  
 Grolier MM Ency. 6.0  
 King Quest V  
 US / World Atlas MPC  
 CP-55 Speakers  
 Headphone Microphone

**\$539.95**

**CD ROM TITLES**

|                                   |         |
|-----------------------------------|---------|
| Sport Best 3 Games                | \$24.95 |
| Mix Up Mother Goose               | \$24.95 |
| Dictionary Of The Living World    | \$36.95 |
| Family Doctor MPC                 | \$24.95 |
| Grolier Encyclopedia 6.0 MPC      | \$64.95 |
| Languages Of The World            | \$29.95 |
| Animals MPC                       | \$24.95 |
| Macmillan Dictionary For Children | \$29.95 |
| Mayo Clinic Health Book MPC       | \$29.95 |
| US & World Atlas MPC              | \$24.95 |
| CD Deluxe 4 Titles Pack           | \$44.95 |
| So Much Shareware III             | \$24.95 |
| PC-SIG 12th Edition               | \$29.95 |
| Midi Music Shop                   | \$19.95 |
| Bookshelf 93                      | \$64.95 |
| Sound Library                     | \$14.95 |
| Ms Works                          | \$64.95 |
| Micropose Best 4 Games            | \$24.95 |
| Atlas 4.0 MPC                     | \$21.95 |
| Audubon Mammals                   | \$19.95 |
| Compton Mult. Ency.               | \$69.95 |
| Playing With Languages            | \$24.95 |
| Time Almanac '92                  | \$24.95 |
| Carmen San Diego Deluxe           | \$29.95 |
| Clip Media II                     | \$33.95 |
| Desktop Imaging                   | \$22.95 |
| Dr. Games                         | \$14.95 |
| Dr. Music                         | \$14.95 |
| Dr. Shareware                     | \$19.95 |
| Electronic Home Library           | \$14.95 |
| Dr. Bk. of Home Remedies          | \$21.95 |
| King Quest V                      | \$28.95 |
| Anthony Robin Power Talk          | \$24.95 |
| 20th Century People/Sport/Almanac | \$14.95 |
| Guinness Book of Record '93       | \$28.95 |
| Time Table of Politics            | \$22.95 |

**100's of Unlisted Titles Available**

**Create your own Bundle Pick any 4 titles & Receive 20% OFF Regular Price**

**CD ROM**

**PANASONIC 562**

**\$259.95**

**TOSHIBA 3401**

**\$479.95**

**FAX MODEM**

**EVERCOM**

WinFax & DosFax LITE  
 LIFETIME WARRANTY  
 1-800 TOLL FREE SUPPORT

96241\* \$49  
 14.4 I \$179  
 14.4 E \$199

\*Bundle with BitFax & BitCom

**PRINTERS**

**EPSON STYLUS 300**

**\$329.95**

**EPSON STYLUS 800**

**\$389.95**

**GAMES**

Over 1000 Games Are Priced Too

**LOW**

To Advertise

**GUARANTEE**

**COMMUNICATION**

**DELRIINA SUITE**

WinFAX & WinCOM

**\$89.95**

**WORD PROCESSOR**

**MICROSOFT WORD 6.0**

**\$399.95**

COMPETITIVE UPGRADE

**\$169.95**

# LOGIC COMPUTER HOUSE

'Where PRICING & SERVICE Make Sense'

Sales End JAN 31 '94

**Store Hours:**  
 Mon-Fri. 9:00a.m - 9:00p.m  
 Sat. 9:00a.m - 6:00p.m  
 Sun. 12:00a.m - 5:00p.m

**WAREHOUSE OUTLET**  
 7310 Woodbine Avenue (Denison & Woodbine)  
 TEL: (905) 415-0909  
 FAX: (905) 415-0911

**MISSISSAUGA LOCATION**  
 1590 Dundas St. E (Hwy 427 & Dundas)  
 TEL: (905) 276-9995  
 FAX: (905) 276-5108

- Government & Corporate PO's Accepted  
 - Dealers are Welcome

\*Some products not exactly as illustrated & While Quantities Last - We reserve the right to limit quantities - Logic Computer House disclaims any proprietary interest in trademarks or trade name except it's own - Price and availability Subject to change without notice \*OAC Based on a 36 month term. All Sales already cash discounted. Any other form of payment will be cash discounted price plus 3% 15% re-stocking charge. All advertised sales are final.

# The MEDIA CD SHOP

✦ Multimedia CD ROM Software ✦

buy two and get the third one at **unbelievable** price!

Over 500 CD ROM Softwares on sale!

The best price & the best selection in town!!!



20 Crown Steel Dr. Unit 12, Markham, Ontario.  
Tel: (905) 940-1502

## Sound Cards

Continued from page 18

puter verbal commands via a microphone and have it respond automatically — 'look ma, no hands!'

As with the SB Pro, there is a CD-ROM interface. At present only the Panasonic/ Matsushita type is available, but it works fine. The MIDI Kit can be bought separately to attach a MIDI keyboard to the SB-16.

A control panel for creating your own banks of patches and altering the card's settings is supplied with the WaveBlaster daughter board. This is handy if you intend to use it as a MIDI music device, and you can save as many of these setups to disk as you like (some banks, including MT-32, are supplied). The only problem is there is no way of auditioning a sound, so you can't actually hear what you are doing.

Also included is Cakewalk Apprentice, a cut-down version of Cakewalk Pro for Windows which is, one of the best MIDI sequencers on the market. This Apprentice version lacks some features, like SMPTE sync control and multiple MIDI ports, but it is nonetheless an excellent entry-level sequencer.

With the higher cost of the SB-16 ASP you have to consider whether you really need this much sound card. Sixteen-bit audio is the wave of the future, but unless you are into serious multimedia or want to dabble with CD-quality digital audio you won't notice much difference. With the addition of the WaveBlaster daughter board, though, a quality General MIDI synth gives much better MIDI music for games and multimedia alike.

## Media Vision

**Pro Audio Spectrum 16 and Pro Audio Studio 16**

The range of sound cards from Media Vision is not all that different to the SoundBlasters, and as such, much of what I have said about the SB range applies to these cards. They deserve their own special place in this feature, however, because they are a major competitor for the quality sound card market.

The first Media Vision card was the Thunderboard, which to all intents and purposes was the same card as the SoundBlaster Basic. Then came the Pro Audio Spectrum (comparable to the SB Pro).

Neither of these cards are readily available any more. The latest in the range is the Pro Audio Spectrum 16, which, as you may have guessed, is comparable to the SB-16. It uses the same OPL3 FM chips, providing up to 20 voices for music, and offers 16-bit digital audio at sample rates from 11.025 to 44.1 KHz in stereo-CD quality. They are SoundBlaster compatible, but only in mono.

There are actually two different versions of this card — the Pro Audio Spectrum 16, and the Pro Audio Studio 16. The cards themselves are virtually identical, with the only difference being the bundled software.

With the Pro Audio Spectrum 16 you get TrakBlaster Pro, an excellent MOD file player and recorder for DOS. Not to be confused with MIDI files, MODs began life on the Amiga, and are like 4-track sequenced songs that use digital samples for their instruments and play on the digital audio section of the sound card. There is also a DOS MIDI sequencer, digital recorder,

mixer control, and the ubiquitous Monologue for Windows.

With the Pro Audio Studio 16 you get all of the above, plus a CD audio player for Windows; MidiSoft's Recording Session for Windows for a MIDI sequencer (and a good one it is, too); ExecuVoice, a voice recognition program with a neat little clip-on microphone; and the superb Sound Impressions, a complete suite of multimedia tools.

Sound Impressions looks like a standard hi-fi rack and includes a MIDI file player, CD Audio player, Digital Recorder and Mixer. The Digital Editor included with this program is the best I have seen in a sound card bundle. It allows you to add effects like Flange, Chorus and Echo, resample, noise filter, reverse, and more. It is fast, stable, and a joy to use.

The Pro Audio cards are shielded to reduce RF interference and use 16-bit DMA for digital processing. As a result, the sound quality is excellent. They also come with a SCSI CD-ROM interface, and a MIDI breakout box called the MIDI Mate can be bought separately. The only drawback to such a well-specified card is that it is still using FM synthesis for MIDI.

## LaserWave

Just to muddy the waters even more, the Media Vision range of cards are also available under a different name and are distributed by a different company — ACS (GMS Datalink in Canada — Ed.). In this range is the LaserWave Classic — same as the original Thunderboard, but with an added CD-ROM Interface. Bundled software is Thunder Master, a wave editor.

Next in line is the Laserwave 16, which is identical to the Pro Audio Spectrum 16, except



**olivetti brother. Canon**

# COMPUTERS

Do you want to be?



FUJITSU

COMPUTER PARTNER

COMPAQ

SAMSUNG

Express Micro

LEXMARK

ViewSonic

In Touch with Tomorrow TOSHIBA

AST COMPUTER

AMBRA PERSONAL COMPUTERS

star THE COMPUTER PRINTER

MICROSOFT WINDOWS READY-TO-RUN

**Puzzled? Confused?** HAVE YOU READ ALL THE ADS? STILL DON'T KNOW WHICH COMPUTER TO BUY OR WHO WILL TEACH YOU HOW TO USE IT? COME ON IN TO COMPU CITY AND SEE OUR IMPRESSIVE LINE OF BRAND NAME COMPUTER SYSTEMS, AT HARD TO BEAT PRICES. BRING IN YOUR QUESTIONS AND WE'LL HAVE A COFFEE AND DISCUSS YOUR NEEDS, ANSWER YOUR QUESTIONS, AND COME UP WITH THE BEST DEAL FOR YOU.

Scarborough:  
2632 Eglinton Ave. East  
Scarborough, Ont. M1K 2S3  
269-7777

CompuCity

from the store that gives you more

Mississauga  
308 Lakeshore Rd. East  
Mississauga, Ont. L5G 1H4  
891-8388

EPSON

IBM

LOGITECH

PS/1

there is less bundled software. With this, you get Stereo Studio F/X, a digital wave editor; a mixer panel; Pro Speech, a text-to-speech application similar to Monologue; as well as Windows driver and sample wave and MIDI files.

A new card in the range is the Supra 16 which offers, in effect, a LaserWave 16 and Microsoft Sound System on the one card. It includes support for 8-bit file compression and is still compatible with Adlib/SoundBlaster. Bundled software includes Windat for wave recording and editing; AudioStation, a hi-fi style player; Monologue For Windows; Dragon Talk, a voice recognition program; and, of course, Windows and DOS drivers.

All in all this is a well-rounded group of sound cards. And, if you need MS Sound System compatibility, the Supra gives you the best of both worlds.

**Aztec Sound Galaxy**

This is another range of sound cards that has taken its lead from the SB/Adlib cards. There are four in the range which are currently available. The first three are similar to the SoundBlasters: Sound Galaxy BX (comparable to the SB Deluxe); the NX Pro (comparable to the SB Pro V.2); and the NX Pro 16 (you guessed it, comparable to the SB 16).

All of these are compatible with Adlib/SoundBlaster, as well as with Covox Speech Thing and Disney Sound Source (two far less common standards).

Bundled software is also comparable to the SoundBlaster range in many respects. The Sound Galaxy BX comes with two digital sound editors, Windat and Galaxy Master; a Windows Jukebox; diagnostic utilities and Windows driver; a multimedia scripter for DOS, and demo songs. The cards also provides speakers, though not terribly good ones.

The NX Pro also offers HSC Interactive; Monologue for Windows; a hi-fi style control panel for CD-Audio and Wave files; and a CD Audio player. A choice of the three main types of AT CD-ROM interfaces, as well an optional SCSI CD-ROM interface upgrade is available.

The NX Pro 16 supports all the standards mentioned above, as well as the more recent Microsoft Sound System. A microphone and headphones are provided and the software included is the same as with the NX Pro. It also has the same choice of CD-ROM interfaces as the NX Pro.

A wavetable daughterboard called the Wave Power can be bought (just like the SB-16's WaveBlaster) to give much better-quality MIDI music. This uses an Ensoniq chipset and is fully MPC and General MIDI compliant. Bundled with it is Midisoft Studio for Windows, another decent entry level sequencer.

The fourth offering from Sound Galaxy is the new Business Audio Board (let's call it BABS). This is fundamentally the same as the NX Pro 16 mentioned above, with the same suite of software exactly (which makes it no less desirable), and the same technical specifications (16-bit, CD-ROM interface and so on).

The difference most noticeable to the average user is that it does not include the Covox Speech Thing and Disney Sound Source support (which is no great loss), or, more importantly, SoundBlaster compatibility. It is designed as an alternative to the Microsoft Sound System under Windows only, so this is not the card to get if you are into games.

One good point of the Business Audio Board is that, since it has been designed primarily for use under Windows 3.1, it does not limit itself to the standard IRQ and Port Address settings, which use IRQ 10 and Address 530 by

default. This means that there should be no problem installing BABS alongside another sound card if you so desire, which you would need to do if you still intend to use DOS applications.

Sound Galaxy is proving to be the 'up and comer' in the sound card market. Its products are as good as, and in some respects better than, the competition they set out to emulate, thanks to such things as software control of the card's settings rather than jumper pins.

**Conclusion**

There are other FM-based sound cards not mentioned here, but they are essentially the same as those discussed. I have compared most of the above cards against the SoundBlaster range to avoid repeating myself. The cards all have so much in common, and indeed some come from the same manufacturers.

Technically, these cards are all essentially the same. They use the same FM synthesizer chips to produce music, and digital audio is

now a well-established process. Incompatibilities arise because each company must find its own solution to the same problems to avoid breaching patent and copyright laws. Because of this, you get the mess of standards we have now. SoundBlaster, at least, is seen by one and all as the leader in this area and its name carries weight on any sound card box.

Copyright STReport. Excerpted from a larger report Nov. 26, 1993 No. 9.48.

**MASK**  
THE  
**COMPLEXITY**  
**OF**  
YOUR  
**APPLICATIONS**

When you want your PC to masquerade as an IBM 3270 terminal, but still retain the ease-of-use functions of DOS or DOS/Windows™, there's no disguising that the best emulator for the job is IBM Personal Communications/3270.

IBM PC/3270 is not just another pretty face. Behind the mask you'll find a host of features and functions, all in one box. Things like simplified host file transfer capabilities, hot spots, pop-up pads with customizable macros, emulator APIs, a LAN gateway, and network install.

You'll also find new support for the latest technologies. IPX/SPX (Netware® for SAA™), TCP/IP, V.32BIS, V.42BIS, PCMCIA modems, and enhanced Async support for mobile/home office connectivity are included. IBM PC/3270 supports non-IBM products too, including communications adapters, printers, MS-DOS® and most name-brand PCs.

Don't hide your expectations for emulation. Go to the people who invented the 3270 standard - IBM. For more information, or to order the emulator that will unmask the power of your PC, call IBM Direct at 1-800-465-7999, ext. 999. Or contact your local computer software dealer.

*P.S. We upgrade from ANY emulator product at very attractive prices.*

**IBM**

IBM is a registered trademark and SAA is a trademark of International Business Machines Corporation. IBM Canada Ltd., a related company, is a registered user. Netware is a registered trademark of Novell Inc. MS-DOS is a registered trademark and Windows is a trademark of Microsoft Corporation. © Copyright IBM Canada Ltd., 1993.

# HITS

COMPUTER & ELECTRONICS

**Richmond Hill**  
**Tel: 889-6513**  
 420 Highway #7E, Unit 14  
 Fax (905) 889-3125

**Port Colborne**  
**Tel: 835-2244**  
 633 Main St. West  
 Fax (905) 835-0239

**Scarborough**  
**Tel: 754-8887**  
 63 SilverStar Blvd., A-16  
 Fax (416) 754-8380

**Toronto**  
**Tel: 586-0020**  
 257 Queen St. W.  
 Fax (416) 586-9631

**Mississauga**  
**Tel: 795-1730**  
 1350 Matheson Blvd.  
 Fax (905) 238-1586

A Division of D & W Since 1979

All 'HITS' Systems are 2 Years Parts & Labour Warranty

## PCI Local Bus System

**MICROSTAR 486 PCI Local Bus Main Board**  
*Pentium Upgradable with INTEL OverDrive Socket (ZIF)*  
*256K External Cache Memory*  
**INTEL 80486 DX2-66 MHz CPU**  
**ATI 32-Bit PCI Local Bus w/ 2MB V-RAM**  
**15" Flat Sreen SVGA Monitor**  
*76 Hz Refresh Rate, MPR II Low Radiation*  
**8 Meg Fast SIMM RAM ( Expandable to 112 Meg )**  
**QUANTUM 340 MB IDE Hard Disk Drive**  
*PANASONIC 1.2 & 1.44 Meg Floppy Drive*  
*101 Keyboard & Mini-Tower Case*



**\$2800**

## SPECIAL

|   |   |
|---|---|
| <b>SONY</b><br>Double Speed<br>CD-ROM Drive<br><b>\$259</b>             | <b>OMRON</b><br>(Japan) External<br>14.4 Fax/Modem<br><b>\$199</b>  |
| <b>RAVEN</b><br>Model2405 24 Pins<br>Dot Matrix Printer<br><b>\$239</b> | <b>AAMAZING</b><br>15" Flat Screen<br>Low Radiation<br><b>\$429</b> |
| <b>CANON</b><br>BJ-10sx Printer<br>w/ Sheet Feeder<br><b>\$329</b>      |   |

## VESA IBM-SLC2 System

**IBM-SLC2 VESA Local Bus Main Board w/ CPU**  
 4 Meg RAM, 128K External Cache Memory  
 Trident SVGA Video Adapter w/ 512K  
 170 Meg IDE Hard Disk Drive  
 PANASONIC 1.44 Meg Floppy Drive  
 14" SVGA Monitor ( 1024 x 768 )  
 101 Keyboard & Mini-Tower Case

**486-50MHz    486-66MHz**

**\$1388    \$1488**



## PS/ValuePoint

**IBM Value Point i486DX-33 System**  
 4 Meg RAM, 64K Cache  
 120 Meg HDD, 1.44 Meg FDD  
 Fast S3 Windows Accelerator Card  
 IBM Keyboard & IBM Mouse  
 Slim Line Case  
 DOS & Windows Installed w/ Manuals  
 One Year ON-SITE Warranty by IBM  
 Life Time Tech-Support by IBM

~~\$1997~~

**\$1897**

**CD-Titles**

|                            |    |
|----------------------------|----|
| Animals WIN.               | 24 |
| Arthur's Teacher Trouble   | 28 |
| Atlas Pack (U.S. & World)  | 22 |
| Battle Chess               | 22 |
| Carmen Sandiago Deluxe     | 29 |
| Dictionary of Living World | 36 |
| Dinosaur Adventure         | 22 |
| Family Doctor              | 27 |
| Groliers Encyclopedia WIN  | 55 |
| Kodak Photo CD             | 21 |
| Languages of the World     | 26 |
| Mavis Teaches Typing       | 24 |
| Monkey Island              | 21 |
| Sherlock Holmes            | 19 |
| Space Adventure            | 35 |
| Lotus 123 w/ Smarhelp      | 45 |

**SOUND CARDS**

|                           |     |
|---------------------------|-----|
| Sound Blaster Compatible  | 69  |
| Sound Blaster Pro 2.0 OEM | 129 |
| Sound Blaster 16-Basic    | 189 |
| Sound Blaster 16 Multi-CD | 239 |
| Sound Blaster 16 ASP      | 269 |
| Sound Blaster 16 SCSI-2   | 299 |
| ProAudio Spectrum 16      | 249 |
| Logitech Sound Man 16     | 169 |
| ATI FX/Stereo             | 109 |



**CD-ROM Drives (Controller Included)**

|                                 |         |
|---------------------------------|---------|
| Mitsumi                         | 195     |
| Mitsumi Fast Speed              | 215     |
| Mitsumi Double Speed            | 265     |
| Panasonic Double Speed          | 289     |
| Sony Double Speed               | 259     |
| Sony 31A                        | 229     |
| Texel Int./Ext.                 | 535/635 |
| Toshiba                         | 595     |
| NEC CDR-84                      | 599     |
| NEC 3X Int./Ext.                | 695/795 |
| Creative Lab Discovery 8 Kit    | 499     |
| Creative Lab Discovery 16 Kit   | 579     |
| Creative Lab Edutainment 16 Kit | 639     |
| ATI MultiMedia Kit              | 349     |



# Making Great Presentations On Your PC

Your Guide to Effective Multimedia Shows

BY MICHAEL O'DONNELL AND GARY LEONARD

The following excerpt from *Making Great Presentations On Your PC* is reprinted with permission from the authors.

There are over 25 million business presentations given in North America each day. Someone is out selling something to somebody every waking minute of every day. How many one dimensional slide shows and overhead presentations can we expect our audiences to endure?

It is time to freshen our message and our medium. It is time to use three dimensional, multi-sensory messages, to more effectively communicate with our audiences.

The question for you now is, "what kind of messages, and how best to create and deliver them?"

Any presentation software tool will give you similar results. For example, can you tell which word

processing program was used to write a book or which desktop publishing program was used to design and print it? No, you can't. Quite frankly, you probably don't care. As the audience, what you care about is the message, not the tools of the trade or the medium.

As the messenger, however, you care a great deal about the tools and the medium, since they are not all created equal. You should look for tools that you can learn quickly and that you can afford, to efficiently do what you want to do in order to communicate with your audience in the best way

possible.

So, as you shop for the right hardware and software platform, be sure that the cost and complexity of the input matches the output you expect to achieve. The investment and the learning curve required to employ the platform should not outweigh your budget, skill level, or planned applications.

### Using Audio & Visuals

"A picture is worth a thousand words."

The primary reason for using audio and visuals in your presentation is to get the audience to pay attention long enough to understand your message. The second reason is to increase the audience's retention rate of the message once you leave them.

Studies show that people remember 10 percent of what they read, 20 percent of what they hear, 30 percent of what they see, and 70 percent of what they see and hear. The more complex the idea or product, the greater the need for audio and visuals.

American companies certainly know this. They spend \$12 billion annually on creating and managing presentation graphics. Many companies employ a graphics manager whose sole job is to help the company get its messages across better.

When used properly, audio and visuals can:

- turn abstract thoughts into concrete ideas
- reduce confusion
- increase audience involvement
- make lasting impressions
- reinforce key points

- give presenter a feeling of confidence and control
- provide cues, keeping the presentation on track
- make delivery smoother by replacing speaker notes
- make dull statistics come alive
- freshen an old message.

When used improperly, audio and visuals can:

- overload the senses, inhibit understanding

- entertain without enhancing the message
- upstage the presenter
- impart too much information too quickly
- bore the audience.

PC audio and visuals can include text; graphics; still-frame pictures; 2D, 3D, and sprite animation; stereo sound, MIDI and voice narration; and live-motion video. In PC terms, this is called data.

## Short Memories, Lasting Impressions

Remember your favorite teachers? Chances are you don't remember much about what they taught you. You just remember them as good teachers. You remember HOW they taught, not what they taught. Chances are you also remember them simply because they were LIKEABLE.

Studies indicate your audience is only going to remember about 10 percent of what you say when you use conventional presentation media, such as slides and overheads. They are likely to forget most of it within a week. That doesn't mean they will forget you. They will remember you as a good presenter, an okay presenter, or a poor presenter: how you present is what they will remember.

Your presence (i.e., your confidence, knowledge, enthusiasm, dress, and mannerisms) will account for about 40 percent of how well you are received. Your voice will account for 30 percent, your medium about 20 percent and your message only about 10 percent.

Your audience will also remember whether or not they liked you in general.

If you listen to 10 people after they have attended a mediocre presentation, you are likely to hear people comment on:

- the presenter's clothes, hair, makeup or gestures.
- how loud, soft, or funny sounding the presenter was.

- how they had to squint to see the overheads or how boring the slides were.
- a story, joke, anecdote, or piece of trivia used by the presenter.

If the presentation was a good one, the percentages change only slightly. More people will remember more of the message. They will overlook or care less about the quirks of the presenter.

However, recent studies indicate that people's retention rates improve considerably after they experience a multimedia presentation. The use of pictures, graphics, text, sound, animation and video all increase the attention and retention of the audience. That retention rate is increased further by adding the interactive element that true multimedia presentations allow. People not only remember the presenter's presence, they also remember much more of the presenter's message.

The point here is that the impression you make as a presenter is just as important as the message itself. It's not only what you say, it's how you say it. The way you present and the medium you use to reinforce your message, i.e., computer-generated audio and visuals, is what will leave a lasting impression.

Being known as "the guy or gal who uses the computer" is not a bad position at all. At least they will remember you for something. ■

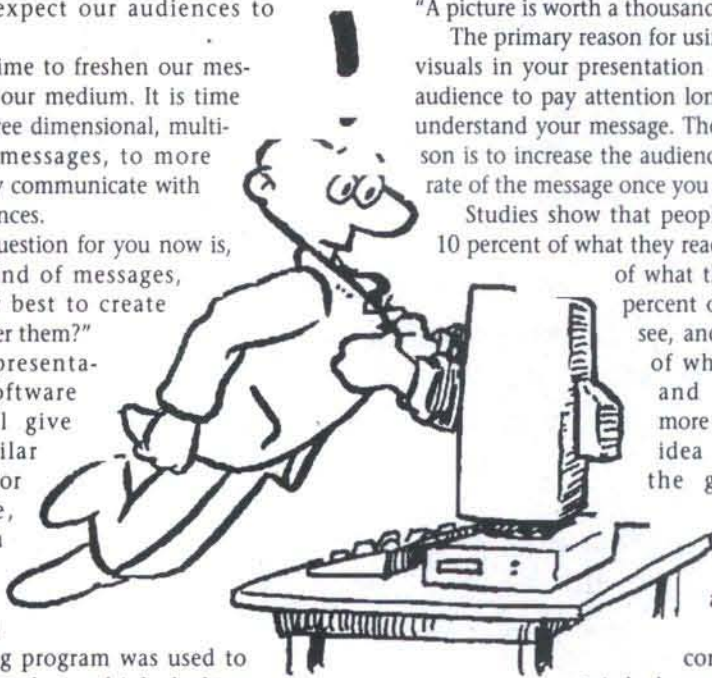

|   |  |   |  |
|---|--|---|--|
| <p><b>Rocket Computer Systems</b><br/>23 Milliken Blvd. Unit B9 Scarborough, Ontario M1V 5H7<br/>Tel: (416) 609-0946 Mon - Fri / Sat 10:30 - 7 / 6:00</p>   |  | <p>Steeles Ave. E.<br/>Kennedy<br/>Milliken<br/>Finch E.<br/>Rocket</p>   |  |
| <p>386DX-40, 128K \$150<br/>486DLC-40, Math. Co. VESA \$269<br/>486DX-33, 128K VESA \$459<br/>486DX2-66, 128K VESA \$725<br/>486DX-40, 128K VESA \$459<br/>Mini-Tower Case, 220W \$60<br/>Med-Tower Case, LED 220W \$90<br/>Full-Tower Case, LED 250W \$135<br/>Desktop Case, 220W \$60<br/>Cirr. Logic 1M VESA SVGA Card \$120<br/>Genoa 1M VESA SVGA Card \$160<br/>Trident 1M SVGA Card \$85<br/>VESA IDE Controller (2S/1P/1G) \$39<br/>IDE Controller (2S/1P/1G) \$25<br/>245MB IDE Hard Drive \$329<br/>340MB IDE Hard Drive \$379<br/>420MB IDE Hard Drive \$469<br/>HP 4P Laser Printer 600dpi \$1315<br/>Canon BJ-200 Bubble Jet Printer \$359<br/>Samsung 2412 24-pin Printer \$189</p> |  | <p>Mitsumi CD Rom (250ms, 350K) \$275<br/>Mitsumi CD Rom (350ms, 150K) \$200<br/>Daewoo 15" NI Low-Rad. Monitor \$495<br/>Orchestra 14" NI Monitor 1024 \$339<br/>Amazing 14" Int. Monitor 1024 \$305<br/>TATUNG 14" VGA Monitor .39 L.R. \$240<br/>DSI Fax/Modem Ext. 14.4 S/R \$235<br/>DSI Fax/Modem Int. 14.4 S/R \$195<br/>Zoltrix Fax/Modem 96/24 S/R \$55<br/>SB comp. Sound Card w/Speakers \$65<br/>Keytronic Keyboard (E03601Q) \$55<br/>IBM Style Click Keyboard \$48<br/>Mtek 101-Enhanced Keyboard \$25<br/>6 Titles CD Bundle \$105</p>   |  |
| <p><b>PCI LOCAL BUS BUNDLE: \$1,210</b><br/>* PCI Motherboard (3 PCI Slots)<br/>* Intel 486DX-33 CPU, 256K Cache<br/>* Built-in SCSI II Controller<br/>* PCI VGA Card 2MB VRAM, (\$3 Chip)</p>  |  | <p><b>MULTIMEDIA SYSTEMS:</b><br/><b>486DX-33 VESA \$1,969</b><br/>* 128K Cache<br/>* 4MB Ram (70ns)<br/>* Panasonic 1.44MB Floppy Drive<br/>* IDE Controller w/2S/1P/1G<br/>* 1MB SVGA Card<br/>* 14" SVGA N-I Monitor (1024, .28)<br/>* 210M Hard Drive<br/>* SB Compatible Sound Card<br/>* Speakers<br/>* Mitsumi CD Rom Drive (Dbl. Speed)<br/>* 6 CD Titles: (1. MPC Encyclopedia, 2. Animals, 3. World Atlas, 4. US Atlas<br/>* 5. Reference Library, 6. Game)<br/>* Mini-Tower Case (220W)<br/>* 101-Enhanced Keyboard<br/>* MS Compatible Mouse<br/>* ShareWare Programs</p>                       |  |
|   |  | <p><b>INTEL 486 MONTHLY SPECIAL:</b><br/><b>486DX-33 VESA \$1,969</b><br/>* 128K Cache<br/>* 4MB Ram (70ns)<br/>* Panasonic 1.2M &amp; 1.44M FDD<br/>* 340MB IDE Hard Drive<br/>* VESA IDE Controller w/ 2S/1P/1G<br/>* Cirrus Logic VESA SVGA Card w/1 MB (Upgradeable to 2 MB)<br/>* 15" Flat Scrn. SVGA N-I Monitor (Low Rad., 72Hz, 1024, .28)<br/>* Medium Tower Case (220W)<br/>* Keytronic 101-Enhanced Keyboard<br/>* MS Compatible Mouse<br/>* ShareWare Programs</p>  |  |
|   |  | <p><b>486DX2-66 VESA \$1,929</b><br/><b>486DX-50 VESA \$1,899</b><br/><b>486DX-33 VESA \$1,669</b><br/><b>486DLC-40 VESA \$1,469</b><br/>(Upgradeable to 486DX-33/50/66)<br/>* 128K Cache<br/>* 4MB Ram (70ns)<br/>* Panasonic 1.2M &amp; 1.44M FDD<br/>* 245MB IDE Hard Drive<br/>* VESA IDE Controller with 2S/1P/1G<br/>* Cirrus Logic VESA SVGA Card w/1 MB (Upgradeable to 2 MB)<br/>* 14" SVGA N-I Monitor (1024, .28)<br/>* Mini-Tower Case (220W)<br/>* 101-Enhanced Keyboard<br/>* MS Compatible Mouse<br/>* ShareWare Programs<br/>(486DX &amp; 486DLC Systems come with Math.. Co-processor)</p> |  |
| <p>3 years labour &amp; 1 year parts warranty for all systems; All prices are cash discounted &amp; subject to change without notice</p>  |  |   |  |

## TRUE VL-Bus System

**486 DX/33 ..... 1590.00**

Including:

- 1 Mb VL-Bus 32 Bits SVGA Card
- VL-Bus IDE Controller 32 Bits
- 4 Mb fast Ram
- 170 Mb IDE hard disk
- 1.44 Mb high density Floppy Drive
- 14" .28dp SVGA Monitor
- Mini Tower Case w/LED
- 101 Enhanced keyboard
- 3 Button Serial Mouse
- Intel w/Built-in Math Coprocessor

**486 DX/2-66 INTEL....+300.00**

FREE installation to upgrade your Intel DX/33 to DX/2-66

**3/486 Local Bus mother board**

w/128 K Cache, no cpu.....150.00

**270 Mb 12ms hard disk.....325.00**

**PCMCIA 96/24 Fax/Modem....350.00**

## MEMORY Upgrade & Repair

We repair all simm modules including 72 pin IBM PS/2 CALL us before you dispose your dead module.

Price quoted are COD and subject to error & to change without notice. VISA cards subject to surcharge.

1300 DON MILLS RD, SUITE 256, Toronto, M3B 2W6

**CPU** Fax: 510-8423  
 SYSTEMS Tel: 510-8918

Data preparation is a booming industry all on its own. To prepare data for PC presentations is to:

- scan logos and images with a scanner
- create images in a paint program
- animate images in an animation program
- make a chart or graph from a spreadsheet
- import text from a word-processing program
- capture images from a CD-ROM, laser disc, TV or videotape
- shoot still pictures or videotape
- record digital audio or compose MIDI music
- and much much more.

You can prepare your own data if you have the equipment and the talent, or you can hire outside production houses.

Data such as audio and video clips, backgrounds, and clip art can also be purchased. A variety of digital libraries can be purchased or downloaded from the bulletin boards. For example, I bought 200 shareware pictures and line art clips for \$28.00.

It all depends on what kind of audio and visuals you need. For major presentations, you may need some things custom designed.

The nice thing about digital data (audio and visuals) is that once it is prepared, it can easily be modified, updated, copied and reused endlessly without any degradation of the image.

### Using Text And Color

Text is a vital part of any multimedia presentation. The text should always enhance the presentation by focusing the audience on the key points, and helping to explain those points. A picture can emit an emotion, but text (and voice narration) are often needed to explain that emotion.

To understand how to use text requires understanding fonts, typefaces, and point sizes. (See "A Few Words on Type" in the January issue of TCP for detailed information on type basics. — Ed.)

A common mistake, made by even seasoned presenters (but novice designers), is to use too many typestyles, fonts and point sizes in a single presentation. A single slide should never use more than two typefaces. Too many typefaces cause the slide to appear cluttered. After a while the slide looks like one big ransom note.

Remember, strive for clarity! Stick with the same typestyle and only vary the font and point size for emphasis, like headings and sub-headings. Also, be consistent. Use the same typestyle for all titles throughout your presentation, as well as for bullet points or other levels of text.

You should always choose a font and point size that is legible to the entire audience. That is one reason why it is important to know the size of your audience and the display device you will be using prior to developing the presentation.

Slides with an extensive amount of text appear cluttered. You should limit the number of lines of text per slide to six. In addition, each line should have an absolute maximum of 10 words per line. Remember, the slide shows key points. Your verbal commentary on these key points should provide whatever additional detail is necessary.

Another rule of thumb is to limit your slides to one concept each. Keep it simple. People think in bite size chunks. Don't overwhelm them too quickly.

Other design tips include left-justifying text whenever possible, avoiding underlined, bold, or italicized text, and staying away from blocks of capitalized text. Finally, have someone proofread your text. It can be quite embarrassing to have a misspelled word projected on a large screen to an audience.

Color is misused in many presentations. The computer allows you to work with thousands, even millions of colors, but only a small subset is needed for any one presentation. Color is best used to emphasize key points or draw attention to a particular area of the screen.

Colors need to be chosen carefully because they interact differently with each other and with the audience. The human eye will perceive foreground colors differently, depending on the background color.

For example, yellow is warm on white, but harsh on black. Blue is fine on white, but difficult to see on black. Red is bright on white, but appears warm on black. Yellow sets red on fire, but is soothing on light blue.

To get a feel for the different effects of color, you only have to look around you. Next time you are driving around, observe the signs used by McDonalds, 7-Eleven, K-Mart, and other consumer-oriented companies.

It comes down to knowing which colors communicate best. Colors are said to be harmonious when they have something in common. Most colors are compatible when they are neighbors in the spectrum. Vary the values of a color one or two degrees to produce a new, but harmonious shade. Colors are said to be disharmonious when they are exactly opposite each other. Throwing together colors that are opposite to each other on the spectrum can create a very vibrant, but harsh effect. Using this technique to

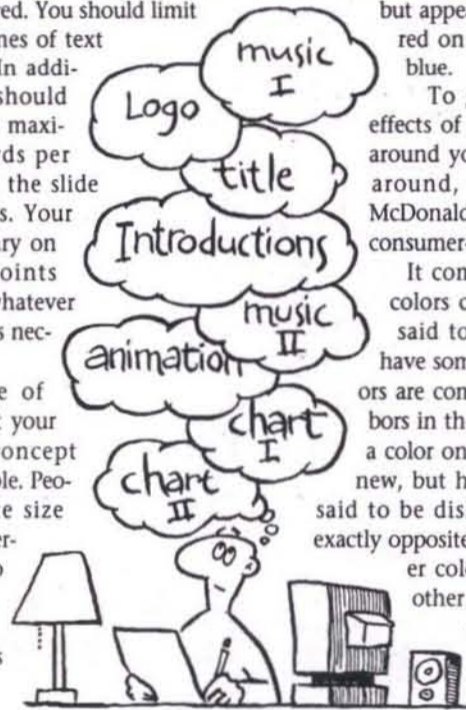

Continued on page 30

Mon - Sat  
9:00 - 6:00

## CAD CONNECTION

**1568 Bloor St. West**  
Toronto (between Keele & Dundas)

Tel: 537-0509 Fax: 537-1354

---

**386-SX-33 MONO**  
1 MB RAM, Mini Tower  
20 MB HD 1.44 FD  
Mono Monitor  
101 Keyboard 2S/1P/1G  
**\$ 565**

---

**386-DX-33/40 SVGA**  
2 MB RAM 128K Cache  
120 MB HD 1.44 FD  
SVGA Monitor & Card  
2S/1P/1G Ports  
101 Enh. Keyboard  
Mini Tower Case  
**\$ 935**

---

**486-DLC-40 SVGA**  
4 MB RAM 128K Cache  
120 MB HD 1.44 FD  
SVGA Monitor & Card  
2S/1P/1G Ports  
101 Enh. Keyboard  
Mini Tower Case  
**\$ 1045**

---

**486-DX-33 SVGA**  
Build In Math Processor  
4 MB RAM 128K Cache  
120 MB HD 1.44 FD  
SVGA Monitor & Card  
2S/1P/1G Ports  
101 Enh. Keyboard  
Mini Tower Case  
**\$ 1335**

**3 YEARS LABOUR 1 YEAR PARTS WARRANTY**

COMPUTERS WITH SOFTWARE  
FOR 486

**RENT**  
386  
286 From \$ **50**

**WE UPGRADE YOUR OLD SYSTEM**

XT/286 to 386 from **\$ 135**  
1 MB RAM to 4 MB **\$ 205**  
2 MB RAM to 4 MB **\$ 175**

Prices are cash discounted and subject to change without notice

# ROLL YOUR OWN CD-ROM'S

Distribute your information on CD-ROM today  
 CD-ROM / MULTIMEDIA Development Software  
 CD-ROM Recorders SONY / Philips / Ricoh  
 Complete CD-ROM Publishing Services

TEXT/DATA/IMAGES/VIDEO/AUDIO

**MISSISSAUGA**  
905-564-2424  
905-564-6655 Fax

**OTTAWA**  
613-782-2473  
613-782-2918 Fax

## BETACORP

TECHNOLOGIES INC.

CD-ROM - CD-ROM XA - CD-I - CD-DA - Mixed Mode - VideoCD - MMCD

# Today's Multimedia PC: The MPC Standard

From Making Great Presentations On Your PC

Today the PC is capable of creating, integrating and displaying not only text and graphics, but also full-color pictures, animation, stereo sound and live-motion video. It can do all this in an interactive fashion, which video tape and television can not do. Television and video as we know them today are passive media. They present information in a linear, and non-interactive, fashion.

The multimedia PC, on the other hand, can respond and react in a dynamic fashion according to the needs and interests of the audience. The ramifications of this are quite dramatic. If you stop to think about the applications of this capability for training, education, entertainment, and presentations — especially presentations — you can't help but get very excited.

The ability to modify presentations while you are on the road, or even minutes from delivery, the ability to instantly jump to different points in your presentation at the request of the audience, and the ability to adjust the speed of the presentation to emphasize or elaborate on particular points makes this interactive presentation technology unbeatable.

The interactive multimedia computer is not only a more powerful medium than television, it may eventually replace it. The multimedia PC enables us to communicate better, more naturally, and faster.

Standards exist for the MPC (Multimedia Personal Computer). These standards allow hardware and software developers to write to a common denominator. The MPC standard is administered by The Multimedia PC Marketing Council, a subsidiary of the Software Publishers Association (SPA). Hardware and software companies can attach the MPC logo to their products if they meet the MPC standards, and, of course, pay the right fees. For the consumer, it is nice to know that products that have the MPC logo meet all association standards.

The MPC standard is NOT the definitive specification for multimedia presentations. A lot of fine presentation products run in DOS as well as Windows. Though many hardware products do not meet every guideline set forth by the council, they are nevertheless very useful multimedia products. In the end, you, the customer, determine the standards.

The MPC standard has evolved with the power and capabilities of multimedia hardware and software. The first standard involved a 286 system, which is frankly not powerful enough for today's multimedia capabilities. The next set of standards, currently in use, is called MPC Level 1. This is a base level multimedia system.

In May, 1993 MPC Level 2 was created. Most MPC systems produced today will meet MPC Level 2.

The following are the key components of the standards:

|          | Level 1             | Level 2   |
|----------|---------------------|---|
| Platform | 16 MHz 386SX        | 25 MHz 486SX  |
| RAM      | 2 MB                | 4MB<br>(8MB recommended)  |
| Storage  | 30 MB hard drive    | 160 MB hard drive   |
| Optical  | No standard         | CD-ROM double speed, multisession with CD-DA outputs, XA ready. |
| Audio    | 8-bit, 11kHz, 22kHz | 8&16 bit, 11kHz, 22kHz, 44kHz                                   |

**Video** VGA, 16 colors. VGA, 65,536 colors.  
**Input Devices** 101 key keyboard;  
 two button mouse (both 1 and 2)  
**I/O** Serial port; Parallel port; MIDI I/O port; Joystick port (both 1 and 2).  
**Compatibility** Windows 3.1 or Windows 3.0 with Multimedia Extensions (both 1 and 2).

Today, any 386 computer is at least capable of creating and running multimedia presentations as the standards suggest. As a rule of thumb, however, I would suggest creating your presentation using an MPC Level 2 system or higher. The playback machine for most of your presentations will be fine at the 386 level 1 specifications. However, with

advancing technology and today's prices I certainly would not buy anything new that did not meet or exceed the MPC Level 2 specs. Today you can buy an MPC Level 2 upgrade kit, which includes a sound card, speakers, and other peripherals, for under \$1,000. You can buy a fully-loaded MPC machine for under \$3,000. ■

## 10th Anniversary Specials

**Bondwell SYSTEM #1**  
 4SX33V Vesa Local Bus  
 Intel 486SX/33MHz,  
**\$1,199**

**Bondwell SYSTEM #2**  
 4DX33V Vesa Local Bus  
 Intel 486DX/33MHz,  
**\$1,479**

**Bondwell SYSTEM #3**  
 4DX50V Vesa Local Bus  
 Intel 486DX2/50MHz,  
**\$1,449**

**Bondwell SYSTEM #4**  
 4DX66V Vesa Local Bus  
 Intel 486DX2/66MHz,  
**\$1,699**



- ALL SYSTEMS INCLUDE:**
- ✓ 3 VESA Local Bus Slots
  - ✓ 128K Cache
  - ✓ 4MB RAM
  - ✓ 1.44MB floppy drive
  - ✓ 245MB hard drive
  - ✓ 2 Serial, 1 Parallel, 1 Game Port
  - ✓ 1MB VESA Local Bus Video Card
  - ✓ MS Serial Mouse
  - ✓ Mini Tower
  - ✓ MS DOS 6.2 & MS Windows 3.1 preloaded
  - ✓ 2 Years Parts & Labour Warranty

**PRINTERS** with system purchase  
**INKJET/BUBBLEJET**

HP DeskJet 500 Plain Paper InkJet Printer **\$399**  
 Canon BJ200 Plain Paper BubbleJet Printer **\$349**  
 HP DeskJet 500C Plain Paper Colour Printer **\$549**  
 Canon BJC600 Plain Paper ColourPrinter **\$769**

**LASERJET**

HP LaserJet 4L 300 DPI, 4 pg/min. **\$949**  
 HP LaserJet 4P 600 DPI, 4 pg/min. **\$1,399**  
 HP LaserJet 4 600 DPI, 8 pg/min. **\$1,879**

**MONITORS** with system purchase

BW 14" SVGA 1024 x 768, .39mm **\$279**  
 BW 14" SVGA 1024 x 768, .28mm **\$309**  
 BW 14" SVGA Non-Interlaced 1024 x 768, .28mm **\$359**

**FAX/MODEMS** with system purchase

Boca 14.4 Internal **\$179**  
 Boca 14.4 External **\$229**

**NAK CAN SERVICE ALL COMPUTERS!**

**MultiMedia Upgrades Kits** with system purchase

**NAKMPC01** **\$299**  
 Package Includes:  
 CD ROM Drive  
 Soundblaster Compatible Sound Card  
 Speakers, Microphone,  
 Software: - Dinosaur Adventure - Space Adventures

**NAKMPC02** **\$499**  
 Package Includes:  
 CD ROM Drive (Double Speed)  
 Soundblaster 16 Sound Card  
 Amplified Speakers, Microphone,  
 Software: - Multimedia Encyclopedia - HSC Interactive - PC Animate Plus - Monologue for Windows

**NAKMPC03** **\$829**  
 Package Includes:  
 CD ROM Drive SCSI (Double Speed)  
 Soundblaster 16 Sound Card (SCSI)  
 Amplified Speakers, Microphone,  
 Software: - Multimedia Encyclopedia - HSC Interactive - PC Animate Plus - Monologue for Windows

Intel is a registered Trademark of Intel Corporation & Bondwell is a Trademark of Bondwell Canada

**NAK Technologies** **1-800-465-5737**

100 West Beaver Creek Road, Unit 20, Richmond Hill (Beaver Creek Business Park) **FAX (905) 764-8352** **(905) 764-7868**

VISA MasterCard American Express

All products are already 3% Discounted for CASH!

# Technology in Review

## Creating Multimedia on Your PC

BY GRAEME BENNETT

Creating Multimedia on Your PC is a 468-page book that comes with a CD-ROM chock full of "try-out" versions of some of the hottest multimedia and graphics products for the PC. The CD also includes samples of multimedia presentations, artwork and sound. This is all fine and dandy (and, at C\$41.95, a heck of a deal), but my experience with the disc, I think, serves to illustrate what's wrong with multimedia on the IBM-compatible platform.

**Giga VL-BUS PREMIUM SYSTEM**

**486 DX33 1,680**  
**486 DX266 1,960**

INTEL CPU  
256K Cache  
4MB Memory 70ns  
Panasonic 1.2 & 1.44 Floppy  
245MB Hard Drive  
IDE Controller, 2S/1P/1G  
Vesa Local Bus SVGA Card, 1MB  
14" 0.28 N.I. Monitor  
101 Enhanced Keyboard  
MS Compatible Mouse  
**FREE**  
DISK HEAD CLEANING KIT  
DISK STORAGE BOX  
MOUSE PAD

CANADA'S #1 BEST-SELLING TAX SOFTWARE

**BRIAN COSTELLO**  
**HOME TAX PLUS™**

CANADA'S BEST SELLING  
PERSONAL TAX PREPARATION  
& FINANCIAL SOFTWARE

WINDOWS VERSION **\$3???**

**Phone Office** Voice mail &  
Fax-on-demand System

Your business, whether large or small, has important  
messages to deliver. FAXON DEMAND provides your customers  
with immediate access to your information, 24 hours a day,  
7 days a week.

**\$ 499.99**

Service Centre  
On-Site Service  
Computer Upgrade &  
Repair

\*\* WE ACCEPT GOVERNMENT & CORPORATE PURCHASE ORDER \*\*

**GigaTrend Computers & Electronics Inc.**  
1670 Kingston Rd., Unit 3A, Pickering, Ont. (Brook & Kingston Rd.)  
Tel: (905) 686-9872 Fax: (905) 686 7413



**Power of Choice**

|                     |                   |               |               |
|---------------------|-------------------|---------------|---------------|
| <b>PLUS EXPRESS</b> | <b>PENTIUM 60</b> | <b>DX2/66</b> | <b>DX/33</b>  |
|                     | <b>\$3729</b>     | <b>\$1879</b> | <b>\$1599</b> |

CPU-VL Bus-Pentium Ready-4MB RAM -1.44MB-250MB HD-VL SVGA 1MB-SVGA 14" NI

ALR PENTIUM ON DISPLAY - WITH WINDOWS NT  
ALR-AMBRA-AST-NEC-IBM ValuePoint-Zenith \$Low  
Notebooks-AST-Epson-HP-IBMThinkpad-Impulse-NEC  
Panasonic-Raven-Samsung-Ti-Toshiba-Zenith \$Low  
Desktops-ALR-AST-IBM-AMBRA-NEC-Zenith  
Dot Matrix-Epson-Fujitsu-Okidata-Panasonic-Raven  
Inkjet-Brother-Canon-Epson-HP-Kodak-Lexmark-T Inst  
Laser-Brother-Canon-Epson-HP-LaserMaster-Lexmark-  
-NEC-Neugen-Okidata-Panasonic-QMS-Raven-TInst  
Color-Canon-HP-Kodak-Lexmark-NEC-QMS  
Faxes-Canon-Goldstar-HP-Okidata-Panasonic-Raven  
IBM ValuePoint S1 486DX/33-4MB/212MB SVGA \$1869  
IBM Ambra Achiever 486SLC2/50-4/170MB SVGA \$1569  
NEC Ready 486es-486SX/25-4/170MB-Svga-Stwr \$1469  
NEC Ready 486es-486/66-4/250MB-SVGA-Stwre \$2349  
Terms: Cash or Cheque w /ID Hours: Mon-Thur 9:30-6:00, Sat 10:00-4:00

**IBM ValuePoint**  
**Ambra Achiever**

**LOWEST PRICE**  
**GUARANTEED**

ALR Evolution V & VQ  
Pentium 60 & 66

**FROM \$3195** 256K or 512K cache  
Upto 1GB RAM  
ISAN/LISA/PCI Bus  
64bit or 128bit architecture

**NEW NEC NOTEBOOK**  
NEC VersaE - 486DX2-40/50

|                  |        |
|------------------|--------|
| DX2/40 Color-250 | \$5988 |
| DX2/50 Color-340 | \$6988 |
| DX2/40 Mono-120  | \$3688 |
| DX2/50 Mono-209  | \$4688 |

**AFFORDABLE NETWORKING!**

Little Big LAN software.

Allows you to network your computers using any combination of Serial ports, Parallel ports, Non-proprietary Arcnet cards, Ethernet cards or Modems! For IBM™ and 100% compatible computers.

**\$99.95\* for the entire network.** No gimmicks! Call for free information pack!

**BIG LAN**

**ACCOUNTING FOR THE NON-ACCOUNTANT**

Mentor Accountant™ V 4.0

Fully integrated accounting. GST Tracking, Inventory Management, Invoicing. Call for full, free details!

**\$199.95\***  
\*PLUS SHIPPING, GST, AND PST

**CARANET CORPORATION**

P.O. Box 218  
Pickering, Ontario. L1V 2R4  
Telephone: (905) 427-2886  
Fax: (905) 683-9599

Here at *The Computer Paper*, we have a 486 DX2-based PC specifically for software and hardware testing. We run DOS 6.2 and Windows for Workgroups 3.11 — presumably a system similar to that owned by many users. For ease of use, we keep it set to boot straight into Windows, and use only Windows software. It's connected to our in-house network, but other than that, it's a fairly stock setup, with 8MB of RAM, a Microsoft Sound System, double-speed CD-ROM drive, ATI graphics card (supplied with a mouse) and SVGA display. No other TSRs (terminate and-stay-resident programs are notorious memory hogs) or device drivers were used, other than those supplied with Windows and the hardware listed above. I was amazed at the roadblocks I ran into when trying to run the software included with this book.

First, allow me to apologize in advance to John Wiley and Sons, the publisher of the book, and to IBM Ultimea, who supplies the CD-ROM disc. The woes I am about to describe may be avoided by carefully reading and following the steps that are prescribed in the documentation included with the disc. I wanted to test the software in a "real-world" environment — that is, on a PC that was already configured and working to my satisfaction.

I deliberately made no special changes to my computer setup before attempting to run the software. I also disregarded, at least temporarily, the written instructions for how to access the disc, and simply booted my PC and popped the disc into the drive, as I suspect many users might do — at least the brave and foolhardy ones.

First mistake: not enough memory (only 8 megabytes of RAM!).

The program insists on having a minimum of 500K of low memory. I threw away at least two hours attempting to solve the problem with memory-management software, to no avail. Aside from managing to completely break Windows so it wouldn't run at all at one point (thanks to an "automatic" memory configuration option that promised 596K of free memory), I was never able to resolve this particular problem and keep all my hardware options functioning. As it turns out, our network software was to blame. A call to the network software company's tech support revealed that there was no way to temporarily unload this particular software, it must be removed from the start-up sequence's Autoexec.bat file. Edit the file. Type, type, type.

Next problem: I was running Windows. The disc, which uses a graphical shell as its main launching menu, requires that it be launched from DOS. If Windows is running, it simply aborts with an error message. Back to DOS. Change directories. Launch the program. Type, type type.

Next problem? "Can't run without a

# Your Only Source for Computer Solutions!

# WORLD

Business Systems Inc.

## OVER 25,000 PRODUCTS

"Discover the WORLD in Business"

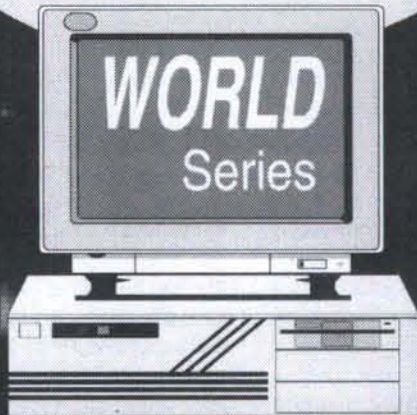

**FREE!**

MS-Dos 6.2  
6-Outlet Surge  
Protector

**FREE!**

Anti-Glare  
Lense &  
Keyboard  
Drawer

| WORLD<br>PCI-3300<br><b>Wizard</b>   | WORLD<br>Vesa-6600<br><b>Advance</b>  | WORLD<br>Vesa-3300<br><b>Office</b>  | WORLD<br>ISA-4000<br><b>Student</b>   |
|--|---|--|---|
| 486dx/33/256k<br>PCI-Vesa (P24T)<br>8mb-Ram 70ns<br>1.22/1.44mb FD<br>Quantum 270mb<br>S3 2mb PCI-Vesa<br>Serial Mouse/Pad<br>14" N.I. 28 SVGA<br>Panasonic CD-562 | 486dx2/66/256k<br>Vesa (P24T) upgr.<br>8mb-Ram 70ns<br>1.22/1.44mb FD<br>Quantum 270mb<br>VLB 5428 2mb<br>Serial Mouse/Pad<br>14" N.I. 28m SVGA<br>Panasonic CD-562 | 486dx/33/256k<br>Vesa (P24T) upgr.<br>8mb-Ram 70ns<br>1.22/1.44mb FD<br>Quantum 270mb<br>VLB 5428 2mb<br>Serial Mouse/Pad<br>14" N.I. 28m SVGA<br>Panasonic CD-562 | 386dx/40/128k<br>ISA / AMD<br>4mb-Ram 70ns<br>1.22/1.44mb FD<br>Quantum 245mb<br>1mb ISA Win/accl.<br>Serial Mouse/Pad<br>14" N.I. 28m SVGA<br>Panasonic CD-562 |

**\$2799      \$2659      \$2389      \$1749**

**BUY WISE - LEASE IT!**

# LEASE

### Networking

|                       |      |
|-----------------------|------|
| Intel 16-bit Coax     | 140  |
| SMC 16-bit Coax       | 140  |
| NetWorth UTP-16A      | 140  |
| Compex 16-bit Coax    | 95   |
| 3-Com 16-bit Boards   | Call |
| D-Link DE-220C 16-bit | 140  |
| D-Link DE-220T 16-bit | 135  |
| NodeRunner2000 coax   | 255  |
| NodeRunner2000 10B-T  | 265  |

### Controllers

|                      |      |
|----------------------|------|
| Adaptec 1522 kit     | 195  |
| Adaptec 1542C kit    | 349  |
| Adaptec 1542C + kit  | 429  |
| Always IN-2000 Pro   | 299  |
| Ultrastor 15-C1      | 299  |
| Trantor T130 SCSI    | 95   |
| Super Multi I/O VLB  | 39   |
| Future Domain SCSI   | Call |
| DTP caching IDE/SCSI | Call |

### Scanners

|                        |      |
|------------------------|------|
| Epson S600 Color       | 1129 |
| Epson S800 Color       | 1519 |
| Microtek II 800 Color  | 1199 |
| Microtek II-XE Color   | 1529 |
| HP ScanJet Color       | Call |
| Logitech Scanman 256   | 249  |
| Logitech Scanman Color | 599  |
| AVR 8000 Color kit     | 1589 |
| Mustek Color Artist II | 499  |

### Memory

|                           |      |
|---------------------------|------|
| SIMM 1mb 70ns             | 58   |
| SIMM 1mb 60ns             | Call |
| SIMM 4mb 70ns             | 199  |
| SIMM 4mb 60ns             | Call |
| PS/2 Memory               | Call |
| Printer Memory upgrds.    | Call |
| Math Co-Pro's SX/DX       | \$99 |
| Memory Installations!     | \$26 |
| Hard/Drive Installations! | \$26 |

2 Year Parts  
5 Year Labour  
**100%**  
Canadian  
Warranty

Makes A  
**WORLD**  
of  
Difference  
Compare  
Value

### Hewlett-Packard

- \* HP LaserJet 4P
  - \* 2MB Ram Standard
  - \* 45 Scalable Fonts
  - \* PCL5-E "NEW"
  - \* 4ppm, 16mhz Intel
  - \* 250 Sheet Paper Tray
- 1329**

### Printers

|                      |      |
|----------------------|------|
| Panasonic 2123       | 289  |
| Panasonic 2124       | 389  |
| Panasonic 2624       | 519  |
| Fujitsu DL-1150/5800 | Call |
| Canon BJ200 S/F      | 375  |
| Canon BJ230 S/F      | 529  |
| Canon BJ330 S/F      | 639  |
| Canon BJC600         | 775  |
| Canon BJC820C        | 1379 |
| HP-500               | 399  |
| HP-550C              | 795  |
| HP-1200C             | 1819 |
| HP-Laser 4L          | 899  |
| HP-Laser 4P          | 1329 |
| HP-Laser 4           | 1929 |
| HP-Laser 4M          | 2629 |
| Epson Stylus 800     | 429  |
| Epson Action 1500    | 889  |
| Genicom 3840E        | 2199 |
| Alps DXM 800         | 1529 |
| Alps LSX 1000        | 1709 |
| Lexmark 4039-12L     | 3199 |
| Lexmark 4039-16L     | 3799 |
| Lexmark ColorJet PS  | 3299 |

### Notebooks

|                       |      |
|-----------------------|------|
| AST PowerEx 486dx/40  | Call |
| AST PowerEx 486sl/25  | Call |
| Toshiba T1950 M/C     | Call |
| Toshiba T4500/4600C   | Call |
| NEC Versa 486sl/25    | Call |
| NEC Versa 486slc/33   | Call |
| Samsung 486sl 4-120   | Call |
| IBM ThinkNote 350M/C  | Call |
| Zenith Z-Star 486 M/C | Call |

### ALPS

- \* 10ppm, 600dpi
  - \* HP-Laser 4 compt.
  - \* PCMCIA slot,
  - \* 2mb-Ram upgd. 32mb
  - \* 45-scalable fonts
  - \* Uses HP-Toner cartr.
- \$1709**

### Video/Cards

|                        |      |
|------------------------|------|
| ATI Ultra + 2mb ISA    | Call |
| ATI Ultra Pro 2mb ISA  | Call |
| ATI Ultra Pro VLB 2mb  | Call |
| Diamond Pro 2mb VLB    | 489  |
| Diamond Viper VLB 2mb  | 509  |
| Herc Graphite 2mb VLB  | 529  |
| Trident 8900-c 1mb ISA | 89   |
| Weitek P9000 2mb VLB   | 449  |
| Curis 5428 VLB 2mb     | 189  |

### Fax/Modems

|                         |     |
|-------------------------|-----|
| Boca 14.4 F/M ext.      | 249 |
| Boca 14.4 F/M int.      | 219 |
| Practical 14.4 F/M int. | 279 |
| Practical 14.4 F/M ext. | 295 |
| IBM 14.4 F/M int.       | 175 |
| PC-Logic 14.4 F/M int.  | 175 |
| Intel Sati 400          | 385 |
| Intel Sati 400E         | 439 |
| Us-Sport 14.4 ext.      | 239 |
| Us-Sport 14.4 int.      | 209 |
| ZyXel U1496E ext.       | 419 |
| ZyXel U1496E+ ext.      | 619 |

### Monitors

|                   |      |
|-------------------|------|
| Nec 3-V           | 799  |
| Nec 5-FGP         | 1899 |
| Nec 6-FG          | 2989 |
| Mag 15-F          | 679  |
| Mag 17-F          | 1379 |
| Sony CPD-17"      | 1379 |
| Orchestra 14"     | 339  |
| Orchestra 15"     | 499  |
| Orchestra 17"     | 979  |
| Mitsubishi 17"    | 1339 |
| Mitsubishi 20"    | 2479 |
| Mitsubishi 21FS   | 2829 |
| Viewsonic 15      | 679  |
| Viewsonic 17      | 1539 |
| TVM LR-4A+        | 399  |
| TVM LR-5A+        | 589  |
| WORLD Digital 17" | 999  |
| Samsung 17"       | 1099 |

### Panasonic

- \* CD-562 int. Bundle
  - \* Sound Bla.16ASP M/CD
  - \* Double Speed CD-Rom
  - \* KOSS PCM-225 spkrs.
  - \* Microsoft 18-Titles CD-Package
- \$709**



### Software Alert!

|                         |      |
|-------------------------|------|
| Aldus Page 5.0 upgrd.   | 179  |
| Corel Draw 4.0 upgrd.   | 269  |
| MS-Access "New"         | Call |
| MS-Office 4.0 upgrd.    | 309  |
| MS-WorkGroups 3.11v     | 79   |
| MS-Windows NT           | 389  |
| MS-Video for/Win        | 189  |
| MS-Visual Basic         | 239  |
| MS-Visual C++ Pro       | 265  |
| MS-Word for/Win.        | 149  |
| Borland Paradox         | 159  |
| Borland Office          | Call |
| Borland Quattro Pro     | 79   |
| Borland Turbo C++       | 109  |
| Lotus 123 for/Win.      | Call |
| Lotus Freelance         | Call |
| Lotus Smart Suite       | Call |
| Lotus Ami Pro 4.0       | Call |
| Norton Anti Virus       | 109  |
| Norton Desktop          | 139  |
| Norton PCAnywhere       | 149  |
| Norton Speed Cache +    | 89   |
| OS/2.1 upgrd.           | 129  |
| Stacker for/Win.        | 79   |
| Winfax Pro 3.0          | 109  |
| Perform Plus            | Call |
| Dynacom GOLD            | 119  |
| Lantastic 5.0 kit       | Call |
| Quark Express for/Win.  | 769  |
| ProComm Plus for/Win.   | Call |
| Hyper Access 5 3.1v     | Call |
| Adobe Photoshop         | Call |
| Harvard Graph 2.0 upgr. | 109  |
| Q & A for/Win.          | Call |
| Dashboard for/Win.      | Call |
| Xtree for/Win. 2.0      | Call |
| FaxWorks 3.0 "New"      | Call |
| lap-link 5.0v "New"     | 169  |

### Diamond

- \* Viper 2mb VRAM
  - \* Vesa LB Accelerator
  - \* 50 Million Winmarks
  - \* Macromedia Action
  - \* 16.7 Million Colors
  - \* 5 Year Warranty
- \$509**

### Hard/Drives

|                     |      |
|---------------------|------|
| Quantum IDE 245mb   | 319  |
| Quantum IDE 270mb   | 339  |
| Quantum SCSI 245mb  | 395  |
| Quantum SCSI 525mb  | 759  |
| Quantum SCSI 700mb  | 1125 |
| Quantum SCSI 1.05GB | 1249 |
| Quantum SCSI 1.2GB  | 1559 |
| Maxtor SCSI 340mb   | 779  |
| Maxtor SCSI 540mb   | 1079 |
| Maxtor SCSI 1.2GB   | 1699 |
| Seagate SCSI 420mb  | 1025 |
| Seagate SCSI 525mb  | Call |
| Seagate SCSI 1.05GB | 1420 |
| Seagate SCSI 2.1GB  | 2519 |
| Toshiba SCSI 899mb  | 1020 |
| Toshiba SCSI 1.02GB | 1159 |
| Toshiba SCSI 1.2GB  | 1199 |
| WDD IDE 256mb       | 319  |
| WDD IDE 340mb       | 395  |
| WDD IDE 440mb       | 495  |
| ALPS IDE 245mb      | 285  |
| Fujitsu SCSI 1.04GB | 1259 |
| Fujitsu SCSI 1.5GB  | Call |

### Tape Back-Ups

|                       |      |
|-----------------------|------|
| Colorado DJ/250 int.  | 259  |
| Colorado Trakker 250  | 479  |
| Colorado Power 2GB    | 1499 |
| Archive 250 w/tape    | 249  |
| Archive Viper 150mb   | Call |
| Archive Mstream 250mb | Call |
| Archive Python 4-8GB  | Call |
| Image (Bernouli)      | Call |
| Syquest Drives        | Call |
| Conner 250mb int.     | 209  |

### Toshiba

- \* CD-Rom XM3401B
  - \* Fast 200ms/sec Trans.
  - \* Huge 330kb/sec Trans.
  - \* MPC2 & Kodak Multises.
  - \* Internal CD-Rom Drive
  - \* 2nd To None!
- \$545**

### CD-Rom's

|                         |      |
|-------------------------|------|
| NEC CD-3XE ext. Bndl.   | 989  |
| NEC CD-3XI int. Bndl.   | 859  |
| Toshiba XM3401 int.     | 545  |
| Toshiba XM3401 ext.     | 679  |
| Sony CDU-561 int.       | 599  |
| Pioneer DRM604X ext.    | 1719 |
| Mitsumi FX0001 int. kit | 289  |
| Panasonic CD-562 kit    | 289  |
| Creative/Labs OMNI int. | 415  |

### MultiMedia

|                           |      |
|---------------------------|------|
| Sound-Blaster 16          | 189  |
| Sound-Blaster 16 ASP M/CD | 289  |
| Sound-Blaster 16ASP SCSI2 | 319  |
| Creative Video Blaster    | 439  |
| Pro-Audio Studio 16       | 289  |
| Pro-Audio Studio XL       | 509  |
| ATI stereo FX-CD          | 179  |
| Logitech Soundman         | 169  |
| Intel Sma/Video Rec.      | 709  |
| Cardinal SNAPplus         | 1019 |
| Gravis Ultra Sound 16     | 189  |
| Creative Spigot           | Call |

**BUYER BE WARE! " We Believe In Total Customer Satisfaction "**

**Corporate &  
Government Po's  
Welcomed**

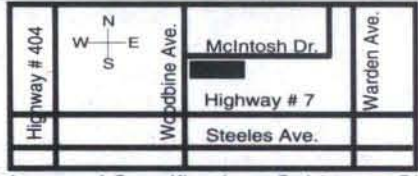

Order/Line:(905) 470-5760  
Sales/Line:(905) 470-5766  
24hour Fax:(905) 470-5772



5 McIntosh Dr. Unit 6 Markham, Ont. L3R 8C7

**Hours-Open**  
Mon-Fri. 9:00am-8:00pm  
Saturday 9:30am-5:00pm

Prices and Specifications Subject to Change With Out Notice - All Products Above are 3% Discounted for CASH!

mouse driver." What?! I was just running Windows with a mouse a few seconds ago! (Windows, for those who don't know, supplies its own mouse driver, which can often save about 20K of precious memory.) Solution: scramble around looking for the ATI mouse driver disc. Install. Reboot. Exit Windows. Launch it from DOS again. Type, type, type.

Are we having fun yet? Things are looking good! This time, I get to the main menu. Hurray! There's a list of choices. Hello,

what's this? A working model of Fractal Painter sounds like fun. I click it, it launches. Uh-oh. Another error message: "Requires single-plane display with at least 256 colors." What the heck is a single-plane display? The culprit in this case turned out to be Windows for Workgroups 3.11, to which we had recently upgraded. It had disabled the 256-color ATI driver that had previously been installed, and enabled its default 16-color VGA driver instead. Enter Windows. Fiddle. Exit Windows. Type, type, type.

Finally — hallelujah! It's running the shell, it's launching Fractal Painter. I exit Painter, it's back to the shell. This is pretty nifty after all, I'm thinking, as I launch another demonstration. Hmm, how about StrataVision 3d for the PC? Uh-oh. Why have my screen-colors gone berserk?

This story goes on and on, in that sort of funny/sad style that makes popular TV movies. Unfortunately, as I discovered, it makes for pretty lousy PC multimedia. Suffice it to say that PC multimedia, in my experience, tends to be this way. If you are committed to using an IBM-compatible platform, your best bet is to purchase a machine pre-configured for multimedia, such as one of the IBM Ultimedia systems. Many of these problems are directly related to DOS. If you chose to run, say, OS/2 2.1, you would solve some of these problems (especially the memory-related ones), and possibly substitute a whole new set of problems. Your fax/modem software might stop working, your sound card or network software might not have an OS/2 driver, etc. (The disc, as you might expect, coming from IBM, fully supports OS/2).

If you are wise or lucky enough to have a dealer help you set up a properly equipped and configured multimedia PC system, you'll find that it is possible to end up with a system that is relatively trouble-free. A good 486-based PC offers plenty of CPU muscle to deliver decent multimedia presentations with high-quality animation, graphics and sound. It's the configuration that is the challenge, especially on ISA bus-equipped PCs, where add-on cards require that DIP switches or jumpers be fiddled with in order to control IRQ interrupts, memory addressing, and other PC esoterica.

Machines with buses based on IBM's Microchannel architecture, Apple's Macintosh NuBus, Amiga's Zorro II or III, or Intel's

new PCI standard do not have to be manually configured. You just plug the card in and it works. Because multimedia is so hardware- and configuration-intensive, I categorically recommend one of these architectures.

**Macintosh Multimedia**

The Mac's strong suit is ease of use. Multimedia on the Mac is predictably simple. A multimedia-enabled Mac such as the Quadra 840AV or 660AV includes, at least minimally, everything necessary to record and play back audio and video with a computer. The audio and video connections are built right in. The Macintosh supports 16-bit sound, animation, Photo CD and image compression at the system software level, so there's little chance of hassles there. If the model is equipped with a built-in CD-ROM drive, there's nothing to set up there, either.

Sounds rosy, right? The only trouble is that video-playback performance isn't all that hot — even on the fastest Mac. Don't expect full-screen — or even half-screen — QuickTime movies to play back at reasonable frame rates. If you want full-screen/full-motion video, you'll have to throw an additional \$5,000 or so at a Macintosh setup and get a third-party video system such as Radius' VideoVision Studio.

Generally, a PC is a better choice to deliv-

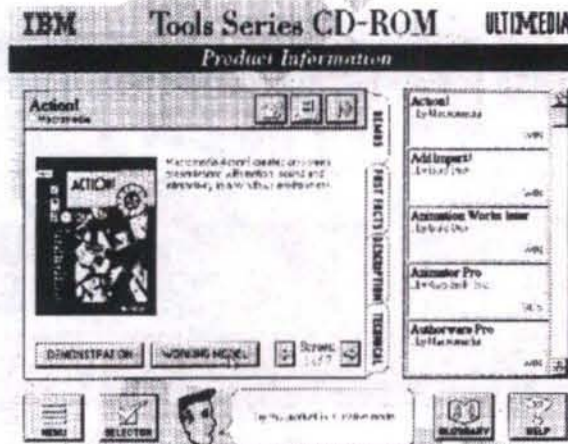

IBM's Ultimedia Tools CD-ROM Reference: Product Selector Screen with Product Selected.

**Power Series**

VESA LOCAL BUS

**486SX33 Mhz**  
**\$1339**

486DX33 Mhz \$1539

- ◆ INTEL 486 CPU, 128K Cache
- ◆ 4MB Ram Expanable to 32MB
- ◆ 170MB IDE Hard Drive
- ◆ Panasonic 1.44M Floppy Drive
- ◆ 14" SVGA .28dp Color Monitor 1024 X 768 NON-INTERLACED
- ◆ Trident Video 512K Exp. to 1MB
- ◆ IDE HD / FD Controller
- ◆ 2 Serial, 1 Parallel, 1 Game Port
- ◆ Mini Tower Case
- ◆ 200 Watt Power Supply
- ◆ 101 Key Enhanced Keyboard
- ◆ MS Compatible Mouse
- ◆ Microsoft DOS 6.2 Installed

**Power Plus Series**

VESA LOCAL BUS

**486DX33 Mhz**  
**\$1997**

486DX2/66 Mhz \$2297

- ◆ INTEL 486 CPU, 256K Cache
- ◆ 4MB Ram Expanable to 32MB
- ◆ Quantum 270MB IDE Hard Drive
- ◆ Panasonic 1.44M Floppy Drive
- ◆ Panasonic 1.2M Floppy Drive
- ◆ 15" FLAT Screen SVGA .28dp 1024 X 768 NON-INTERLACED LOW RADIATION Monitor 70Hz
- ◆ Cirrus Logic VL Bus Video 1MB
- ◆ VL Bus IDE HD / FD Controller
- ◆ 2 Serial, 1 Parallel, 1 Game Port
- ◆ Mini Tower Case w/ LED Display
- ◆ 250 Watt Power Supply
- ◆ KEYTRONIC USA Made Keyboard
- ◆ CORDLESS MS Compatible Mouse
- ◆ Microsoft DOS 6.2 Installed



**CONNELL COMPUTER INC.**

111A Queen St. E.  
Toronto, Ont.  
Tel: (416) 360-6368  
Fax: (416) 360-0487



Open : Mon-Fri 10am - 6:30pm Sat 10am - 5pm

All Prices are cash or certified cheque only. Prices are subject to change without notice.

**WHATEVER YOU WANT, WE WON'T LET YOU DOWN!**

Mon-Fri 10:30 AM - 8:30 PM  
Sat. 11:30 AM - 8:30 PM  
Sun. By Appointment Only

Please Call For More Information

**Powerful V-L Bus**

- 486 DX-33 \$1,449**
- 486 DX-40 \$1,469**
- 486 DX-50 \$1,649**
- 486 DXII-66 \$1,729**

**Complete With:**

- 128K Cache
- 4MB RAM
- 1.44MB Floppy Drive
- 245MB Hard Drive
- SVGA Color Monitor
- V.L. Bus 1MB Video Card
- Super I/O Card with 2S/1P/1G
- Mini-tower Case
- 101 Enhanced Keyboard
- Free Mouse

**Special 486 DLC - 33**

- 2 MB RAM (up to 32MB)
- 1.44MB Floppy Drive (Japan Made)
- 120MB IDE Hard Drive
- SVGA Color Monitor
- SVGA Video Card
- Super I/O Controller Card with 2S/1P/1G
- Mini Tower Case
- 101 Enhanced Keyboard
- Free Mouse

**\$899**

**Hard Drives:**

- 120 MB \$209
- 245 MB \$299
- 340 MB \$359
- 420 MB \$459

**Upgrade Special**

- 386SX-33 \$99
- 486DLC-33 \$169
- V-L 486DX-33 \$459
- V-L 486DXII-66 \$739

Done while for simple work  
No labor charge you wait

**CTS Computer Company**

1182 Queen St. East, Toronto, Ont.  
Tel: (416) 466-7153 Fax: (416) 466-6328

Prices are subject to change without prior notice.

# FREE SOFTWARE

We will give you 1 free software disk just to visit us at our location !!

CONVENIENTLY LOCATED BY:  
FINCH & DUFFERIN

Only valid for walk in at our Dufferin/Finch location with this add. 1 per customer

**NOW OPEN**  
**7 DAYS A WEEK**

**HOURS:**  
Mon - Fri 9am - 6pm  
Sat 10am - 5pm  
Sunday 10am - 4pm

**TO ORDER,  
PLEASE CIRCLE  
TITLES BELOW**

**BONUS:**  
For Every 10 Disks You Purchase  
**PICK 2 FREE**

**PRICES: 1-9: \$3.49 ea 10-49: \$2.59 ea 50-99: \$2.35 ea 100+: \$2.15 ea**

## EDUCATION

- Amy's first Primer (ED 101) A collection of routines for pre-schoolers with alphabet, counting, shapes and colour.
- PC-Touch (ED 107) Super typing Tutor. The best we've seen
- Dinosaur Database (ED 116) A fun educational program that teaches all about dinosaurs with world maps, pictures, common and scientific names. Also displays time periods.
- Googol Math Games (ED 121) Makes learning an exciting adventure. Supports age levels 4 thru 12.
- World Atlas (ED 151) (2 disks) Search by continent, country, or city in this fabulous atlas of the world.
- Dos Learning System (ED 159) A great first tutor for DOS. Learn more about these fantastic machines. You'll love it.
- French I & II (ED 302) Flash card drill familiarizes you with the French language. Review at your own pace.
- Languages (ED 306) Teach or advance yourself with these basic tutors in: French, German, Italian, Spanish.
- Balloo speller (ED 307) Great introduction to spelling for young children. Learn to spell in a fun environment.
- School mom (ED 308) Teaches children ages 2-14 the basics of art, music, spelling, english, and math. GREAT !!
- Funny Faces (ED 309) Make different looking funny faces on your screen. Loads of fun for the young generation.
- Yogi Bear Math Adventure (ED 310) In a remote section of Jellystone Park, The child through an animated adventure VGA
- Teenage Mutant Ninja Turtle Colouring Book (ED 318) Fantastic colouring book for all ages. Children love this !!
- Lotus Macros (SP 104) Short cuts for use with 123 !!
- Lotus Ready (SP 105) Ready made applications. Ready made templates to get you running immediately. LOTS !!
- Lotus Templates (SP 115) (2 disks) Basic tutorial for learning LOTUS 123. Use this to master the program.
- Lotus Learning System (WO 201) (3 disks) Learn all the powerful and new features of this new word-pro Simply the best tutorial on the market.
- Wordperfect 5.1 Macros By Design (WO 202) (2 disks) Superb collection of over 100 helpful macros for WP 5.1
- (DP 110) Word Perfect add on brings desktop publishing to your documents. Creates beautiful graphic polished documents in moments. Sells for \$179.00 in stores

## GENERAL

- PC Lotto (GE 101) Canadian based lotto systems. Covers 40 different lotto systems including Iottario and 649. File of all drawn numbers, best and worst numbers, GOOD LUCK
- Medical Doctor (GE 114) Diagnose various symptoms you have and come out with a treatment !! Fantastic
- Personal Budget Tools (GE 116) Plan your household budget. Keep track of finances and save for those luxuries.
- Horse Racing (GE 123) Handicapping for thoroughbreds. Help increase your odds at the track by 1000 percent.
- INCOME TAX RETURN (GE 138) Fast and efficient method for doing your income tax. Very helpful !!
- PC-LOAN (GE 145) Best loan & Mortgage, Canadian support.
- Collect (GE 170) Lets you track and manage any type of collection by categories of your choice. Antiques, art, audio, cards, books, coins, stamps, movie, ETC.
- Resume Master (GE 191) Resume quickly prepares a professional looking resume. Gives you the winning edge !!
- Edna's Cookbook (GE 202) (2 disks) An electronic cookbook with fantastic new recipes. Add your own as well.
- Brother's Keeper (GE 203) (2 disks) A great genealogy program that allows you to trace your family's history.
- Telx (TE 116) State of the art communications package.
- Solar System Simulation (AS 105) Gives a full simulation of our solar system in VGA graphics. Moon, planets, & more
- Skyglobe (AS 110) Shows 89 constellations as viewed from any location in the world and print them out. Easily the best and most acclaimed astronomy shareware package on the market. CGA/EGA/VGA
- Mcfee Antivirus (SH 107) (2 disks) Latest collection of anti-virus programs Detect and eliminate all known viruses.

## GRAPHICS & DEKTOP PUB

- Curve Digitizer (DP 104) (2 disks) True full featured CAD system. Extensive options, very easy to use. THE BEST !!
- PC Circuit (DP 108) Design printed circuit board layouts and electronic diagrams like magic. Fantastic !!
- Print Partner (DP 109) (2 disks) Printmaster/Printshop clone. Prints banners, signs, calendars, and more. Includes set of 200+ built in graphics.
- Dataworks Clipart I (DP 122) (12 disks) The best clipart collection we have seen in a long time, 500+ PCX graphics !!
- Dataworks Clipart II (DP 123) (12 disks) More of the greatest assortment of graphics for every need !!
- SimCGA (GR 102) Run CGA programs with Hercules type cards an essential program for anyone with a monochrome monitor.
- Printshop Graphics (GR 108) 3 additional libraries, over 200 additional pics - needs printshop. Fantastic collection
- Printmaster Graphics (GR 109) 3 more printmaster libraries
- Printshop Graphics II (GR 111) 500+ images for Printshop
- Printmaster Graphics II (GR 112) (2 disks) 500+ images
- VGA Universe (GR 123) Beautiful slideshow of actual digitized pictures from space. The best graphics VGA
- Printshop Graphics III (GR 125) (2 disks) More graphics for Printshop. This will complete your graphics library.
- Printmaster Graphics III (GR 126) (2 disks) More graphics for Printmaster. This will complete your graphic collection
- Kid Paint (GR 131) Kids go crazy on this program. A colouring book on computer. Songs & animation as well.
- New Printshop Graphics (GR 141) About 700 images of people business, icons, zodiac signs, and more. 24 more fonts !!
- VGA Space Flight Simulator (GR 308) Amazing demo for VGA. Blast off from planet earth and tour the universe. GREAT !!
- GULF !!! (GR 307) A tribute to the troops in the Mideast conflict. Full colour photos and music VGA Req.

## WINDOWS 3.1

- Utilities (WI 110) (4 disks) 40+ utilities that will help you get the most out of windows & make it easy to use.
- Windows Games I (WI 113) Includes Tetris, centipede, atoids, lunar lander, checkers, backgammon, and more !!
- Icons & Icondraw (WI 114) (4 disks) Contains 1100+ icons for windows. Has icons for popular software packages and lets you view, edit, and create your own. FANTASTIC !!
- Windows Games II (WI 119) Space walls, Hextris, Mines, Risk, Pente, Millie bornes, and more. Collect them all !!
- Windows Games III (WI 120) Includes teris, Concentration, Taipei 3.5, Arachnid, Blackout, ataxox, Moku, and Solitaire.
- Windows Games IV (WI 121) Tops off the game sets with Missile command, Cubic, Pacman, Pipe, Wordhal, Tetwin.
- Chess for Windows (WI 122) Two great chess programs for windows 3.0, both play excellent games of chess.
- Winjack (WI 127) Excellent game of BLACKJACK for Windows.
- TRUE TYPE FONTS I (WI 134) (12 disks) The ultimate set of fonts for Windows 3.1. Over 120 fantastic fonts worth \$100's
- TRUE TYPE FONTS II (WI 135) (12 disks) The second set, with another 120 fonts. Fantastic variety !! GET THIS SET !!
- Virus Scan (WI 140) Updated for use with both DOS and Windows
- Benchmark (WI 149) Shows you your windows speed and how to increase your performance. Essential for all !!
- WIN TREK (WI 102) (2 disks) Windows STAR TREK at its best !! Fantastic graphics and game play. ENJOY !!
- FRACTAL (WI 166) A great fractal design program !!
- Termite (WI 167) A hilarious program, termites chew up windows and spit them out on screen. Great prank !!

## VGA GAMES

- SUPER VGA GAME- Moraff's Entrap (HG 102) HIGHLY RECOMMENDED- Supports all monitors up to 1024 X 768. Trap the killer robots throughout the various levels. FANTASTIC
- Mario Brothers (HG 103) Fantastic version of the popular arcade game. Just like the nintendo game. (VGA Req.)
- VGA Wheel of Fortune (HG 115) VGA version of the game with over 200 built in phrases. Add your own phrases.
- Kung Fu Louie (HG 140) (3 disks) This time Louie takes on the martial art posse. Kicks, roundhouses, punches and spinning flying kicks are Louie's arsenal. VGA
- VGA Trek (HG 155) Super Star Trek game for VGA, fight the klingons & Romulins- EXCELLENT GRAPHICS !!
- CATACOMBS OF THE ABYSS (HG 169) Fantastic 3-D graphics just like WOLFENSTEIN in this D&D adventure !!
- LEMMINGS !! (HG 173) A limited version of the best game in the market. This is Fantastic !! A MUST !!
- WOLFENSTEIN (HG 175) (2 disks) The greatest in PC entertainment. Escape from the dungeons of a WWII prison in this 3-D action adventure. VGA, SB support
- Jill of the Jungle (HG 176) Help Jill explore the far reaches of her mysterious jungle domain. Stunning action, great graphics & sound. VGA/EGA/CGA, SB support
- 3-D Flight Simulator (HG 178) SIMPLY THE BEST !! Stunning graphics, Sound card support, & real combat make this one of the best we carry. GET THIS !! VGA
- GALACTIX (HG 179) (2 disks) An opening similar to WING COMMANDER. This game had us spellbound !! Destroy the evil Xidus fleet in your advanced battle craft. VGA req.
- Prince of Persia (HG 183) (3 disks) VIRTUAL REALITY in the most realistic boxing game ever !! The best in VGA !!
- 4-D BOXING (HG 185) ALIENS ATE MY BABY SITTER Help Keen rescue his baby sitter. SB support. VGA
- Commander Keen 6 (HG 186) (2 disks) APOGEE !! Help poor Cosmo find his parents lost on a hostile alien planet. Superb graphics, Sound Blaster, FANTASTIC!! VGA
- Cosmo's Cosmic Adventure (HG 189) 4 amazing levels. Save Lemmings in their snowy domain. SB support. VGA/EGA/CGA
- X-MAS LEMMINGS (HG 190) (2 disks) Find the antidote and save penelope in this graphic adventure. VGA
- HUGO III - Jungle of Doom (HG 191) (2 disks) The full working demo of the greatest flight simulator ever created. The best with incredible graphics, SB support. Fly an F-18 !! VGA
- FALCON 3-D (HG 192) THE LOST EPISODE. Invade Tuberia and destroy King Boobus Toober, a real mean spud !! The best Graphics & Sound Card support. VGA
- SPIDER MAN (HG 194) FANTASTIC !! Use your skills to penetrate the enemy hideout. Sound Blaster. VGA req.
- Carmen Sandiego (HG 196) Blockout is better than any other Tetris we have seen. Fantastic 3D graphics. VGA/EGA
- ELECTRO BODY (HG 202) Are you tired of saving those stupid lemmings, now blow them away in this fantastic spoof !! Stunning graphics, mouse & Sound Card support !! VGA req.
- Crazy Cars III (HG 204) The ultimate car racing game !! Choose from a variety of sports cars and race Pole Position style illegally avoiding the police !! SUPERB VGA
- POOL - Jim Kobe (HG 210) Fabulous pool game with stunning graphics & mouse support. Nothing is better !!
- Carmen Sandiego (HG 217) The shareware version of the popular commercial game, FANTASTIC fun for all. VGA
- ELECTRO BODY (HG 222) (2 disks) ROBO COP at its best. Sound blaster, speech, superb graphics !! Clear this multi level complex of all hostile criminals and robots !! VGA
- MIG 29 Fighter (HG 223) BEST air combat simulator. Fly your MiG & clean up the sky !! Sound card support. VGA !!
- ANCIENTS - The Deathwatch (HG 225) A fantastic 3-D D&D adventure WOLFENSTEIN style !! One of the best !! VGA
- GOLF- Jack Nicklaus (HG 227) (2 DISKS) The best golf game we have seen yet with full sound card support and the best in graphics, overhead and thruway views ETC. VGA
- MAJOR STRYKER (HG 231) (2 disks) APOGEE again !! Fantastic space action as you defend earth from invasion. Full sound card support with incredible graphics !! VGA
- OVERKILL (HG 234) EPIC MEGAGAMES !! Defend your homeland against hordes of evil aliens. Blow them out of the sky with your atomic battlecraft, Sound card !! VGA
- SOLAR WINDS (HG 235) (2 DISKS) FANTASTIC !! our personal favorite game from EPIC !! GREAT graphics and sound blaster support. WING COMMANDER. As Jake Glone, fearless bounty hunter, explore the galaxy !! The ultimate adventure that will keep you glued to your seat for days !! VGA
- NOVA 9 (HG 236) (3 disks) The music and 3-D graphics are simply incredible !! Full sound card support Drive your battle craft over alien terrain in a cockpit just like Wing Commander or F-16 !! UNBELIEVABLE !! We were incredibly impressed with this game, and you will be too. VGA req.
- RED HOOK'S REVENGE (HG 245) As the most dreaded pirate of the seven seas, you brave storms, fight fierce battles, discover treasure, & visit mermaid island in this great adventure. Superb art with SB support. VGA
- JETSON'S (HG 246) Play the role of elmo, George or Astro in this great graphical adventure to save Cogswell's factory. Killer robots lurk at every corner !! A Fantastic spoof of the original television series. VGA
- The Perfect General (HG 249) A fabulous game for all you strategists out there. Great graphics and Sound Blaster support. Use all your skills to win the war for the allies or the enemy in WWII. A strategy classic. VGA
- WOLFENSTEIN - Street Fighter (HG 251) (2 disks) A new Wolfenstein with all new levels, graphics, ninja warriors Adlib/SB support, and more !! THE BEST need we say more ?? VGA
- MORE WOLFENSTEIN (HG 253) (2 disks) New Shareware episode of this years #1 game !! Created by a user with new levels, layouts, & graphics. Sound card and tons of enemy scum to be blown away. VGA
- WOLFENSTEIN - 60 levels (HG 255) 60 custom designed floors on 6 new levels. Some are totally redone, some have been given face lifts. You'll be amazed at all the new twists, adventures, and challenges. Wolf required !!
- SPACE CHASE (HG 264) (2 disks) As The hero Jason Storm you must reach the command centre of station alpha and capture members of Evil Guys Inc. Adlib/SB sound with stunning graphics. VGA
- NINJA RABBIT (HG 265) (2 disks) Fight greuling battles against the international crime ring S.L.I.M.E. Use all your karate moves against your opponents. GREAT !! VGA
- STAR TREK Battle with the Borg (HG 268) The next generations battle with that ugly evil cube. High res animated of the enterprise through warp. VGA
- STAR TREK Combat Simulator (HG 269) The ultimate combat simulator for you trekies !! Control the starship Enterprise while battling it out with all sorts of federation enemies !! Sound card support and great graphics !! VGA
- The Incredible Machine (HG 271) BY SIERRA !! For all you crazy puzzle solvers out there !! The best in graphic thinking games, place objects around a screen to make an event take place properly !! SB support. VGA req.
- KAEON (HG 273) Incredible graphics and sound with more motion and animation than you can shake a stick at !! Pilot your fighter through endless scenarios blasting the enemy. 32-bit game with Adlib/SB support. 386+ & VGA
- EXECUTIONERS (HG 275) (2 disks) Disgusting bloody gory combat similar to Street fighter. NOT FOR CHILDREN !! The greatest graphics and Adlib/SB sound. Get this !! VGA
- ONE MUST FALL (HG 276) The best in KARATE fighting !! Sound card support with stunning graphics, battle the computer or a friend for honor. If you like street fighter, you'll love this one !! One of the best. VGA
- STAR TREK - Combat Sim. (HG 289) The ultimate of battle from the enterprise bridge. VGA
- BARON BALDRIC (HG 280) The GRAVE adventure. Discover the ghost of a slain milkmaid in this hilarious horror spoof with stunning graphics and Adlib/SB support. Definitely get this one !! VGA
- BIO MENACE (HG 281) (2 disk) APOGEE !! Reclaim metro city from evil disgusting mutant scum that shot you out of the sky. One of the best games with full Adlib/SB support. VGA
- KEN'S LABRYNTH (HG 285) (3 disks) BETTER THAN WOLFENSTEIN !! 3-D graphics, Adlib/SB support. Brave the labyrinth for fame, glory & fun. Many enemies, secret rooms, monsters, and evil creatures. The best in graphical 3-D adventure gaming (we're not kidding !!) VGA, and 386+ computer required.
- ZONE 66 (HG 287) (3 disks) EPIC MEGAGAMES !! The newest 32-bit game with full Adlib/SB support. Fly your super fighter through 380 degree playfield blasting enemies in the most spectacular game ever. 386+ computer & VGA required to play the most graphical and awesome game ever !!
- MONSTER BASH (HG 289) (3 disks) HORROR by APOGEE !! Scary Adlib/SB music & effects in Apogee's biggest and best game ever. Young hero Johnny Dash journeys through the domain of count chuck to save his dog Tex. Face countless horrors in the domain of count chuck, monsters, zombies, & more !! VGA
- INDIANA JONES - Fate of Atlantis (HG 238) (2 disks) Help Indy find the lost city of Atlantis in this game similar to KING'S QUEST with sound card support. VGA
- JET PACK (HG 296) Search for fame fortune and SPACE BABES in this action adventure. Strap on your jet pack and journey through hundreds of danger filled levels to discover their hidden secrets & horrors. Sound Blaster Support. VGA
- GATEWORLD - The Speedship (HG 297) (2 disks) Captain Klondike vs GORG. Stop an evil machine in charge of a run away asteroid. Explore underground caverns, avoid traps, evil creatures, security defenses & more. Full Sound Card Music with great graphics make this one game to beat. VGA
- Dungeons of Daloman (HG 307) The ultimate in AD&D type games, similar to Gauntlet in style. Roam the haunted evil caverns in search of adventure and treasure. Battle evil wizards and horrible evil creatures. VGA
- XYPHER (HG 309) UNBELIEVABLE !! Fantastic audio and visual. Control the most powerful and agile space vehicle in the galaxy & defend. Encounter countless enemies, organic, insect, metallic. VGA
- MARBLE MADNESS (HG 314) Ball Game !! is the ultimate in hand eye co-ordination games for the PC. Use all your skills with gravity and a score of other objects as your enemy. FANTASTIC !! One of our favorites. VGA

## THOUSANDS OF TITLES

NOW FEATURING:

# MACINTOSH

A full collection in our showroom !!

Come browse through the thousands of titles and many ALTERNATIVE SHAREWARE titles in our show room. We only carry top quality SHAREWARE that will have you GAWKING with wonder !! The shareware we sell is a fantastic means of software distribution, PLEASE SUPPORT THE SHAREWARE CONCEPT. For more information call 638-4411. If you can't make it to our showroom then call for our FREE CATALOG to introduce you to THE WORLD'S GREATEST SOFTWARE COLLECTION

FREE CATALOG WITH EVERY ORDER !!

FREE CATALOG WITH EVERY ORDER

FOUR WAYS TO ORDER:

- 1 - MAIL YOUR ORDER
- 2 - FAX YOUR ORDER (638-4477)
- 3 - PHONE YOUR ORDER (638-4411)
- 4 - VISIT OUR OFFICE AT FINCH & DUFFERIN



ORDER:

PLEASE CHECK

VISA:

# Disks: \_\_\_\_\_

ALL THAT APPLY

MC:

# Free Disks: \_\_\_\_\_

Street: \_\_\_\_\_

CHK:

Price per Disk: \$ \_\_\_\_\_

City, Prov: \_\_\_\_\_

5%

Post & Hand: \$4.00

Postal Code: \_\_\_\_\_

3%

\*\*SUB-TOTAL: \$ \_\_\_\_\_

Phone# \_\_\_\_\_

CREDIT CARD # \_\_\_\_\_

7% GST on \*\*: \$ \_\_\_\_\_

EXPIRY DATE: \_\_\_\_\_

8% PST on \*\*: \$ \_\_\_\_\_

NAME ON CARD: \_\_\_\_\_

TOTAL: \$ \_\_\_\_\_

**MARCOM COMPUTERS CANADA**

4490 CHESSWOOD Dr. #3, Downsview, Ontario, M3J 2B9

# VOICE MAIL SYSTEMS

|   |  |
|---|--|
| <h2 style="text-align: center;">FAXMOUTH PLUS</h2> <p style="text-align: center;"><b>FAX ON DEMAND</b></p> <ul style="list-style-type: none"> <li>* Intel SatisFAXtion 100 (CAS)</li> <li>* Ideal for distributing product literature</li> <li>* Cuts Mailing Cost / Staff Cost / Printing Costs</li> <li>* Has full voice mail capabilities included</li> <li>* Stores up to 99 million documents</li> <li>* Password protection for sensitive documents</li> <li>* Tracks number of requests for each document</li> </ul> <p style="text-align: center;"><b>\$ 699.95</b></p> | <h2 style="text-align: center;">BIGMOUTH</h2> <p style="text-align: center;"><b>Single Line Voice Mail</b></p> <ul style="list-style-type: none"> <li>* Supports Up to 300 Voice Mail Boxes</li> <li>* Ideal for Small Offices</li> <li>* Outbound Telemarketing</li> <li>* Has full voice mail capabilities</li> <li>* Call Logging</li> <li>* Private passwords for each mail box</li> <li>* Timed Messages</li> </ul> <p style="text-align: center;"><b>\$ CALL</b></p>   |
| <h3 style="text-align: center;">AMANDA</h3> <p style="text-align: center;"><b>2 PORTS</b></p> <p style="text-align: center;"><b>\$ 2495.00</b></p> <p style="text-align: center;"><b>4 PORTS</b></p> <p style="text-align: center;"><b>\$ 3495.00</b></p>   | <ul style="list-style-type: none"> <li>☑ Auto Attendant</li> <li>☑ Call Transfer</li> <li>☑ Call Screening</li> <li>☑ Unlimited Voice Mail Boxes</li> <li>☑ Pager Notification</li> <li>☑ Expandable to 24 Lines</li> <li>☑ Digital Recorded Voice</li> <li>☑ Variable Compression</li> <li>☑ Guest Mailboxes</li> <li>☑ System Announcements</li> <li>☑ Distribution Lists</li> <li>☑ Remote Modem Access</li> <li>☑ On-Line Order Taking</li> <li>☑ Serial Port Access (IVR)</li> <li>☑ Programming Language</li> <li>☑ FAX-ON-DEMAND</li> </ul> |
| <h3 style="text-align: center;">COMPUTEL</h3> <p style="text-align: center;"><b>24 HOUR FAX-ON-DEMAND SYSTEM</b></p> <p style="font-size: x-small;">Retrieve up-to-date product information using our 24 hour FaxmOuth Plus system. Please call using your fax machine telephone.</p> <p style="text-align: center;"><b>[905] 294-8065</b></p> <p style="text-align: center;">TEL: [905] 472-2466</p>   |  |

# READY TO GO PRO?

## PASSPORT MUSIC SOFTWARE DELIVERS!

MACINTOSH & PC WINDOWS COMPATIBLE!

PERFECT FOR BASIC NOTATION & SCORING NEEDS!

### MusicTime™

- Compose, edit, play back music using your computer
- Supports up to six staves of notation with lyrics
- High quality print output to virtually any printer
- Record with a MIDI keyboard and immediately see it in standard notation

THE EASY-TO-USE PROFESSIONAL MIDI SEQUENCER!

### PASSPORT MASTER TRACKS PRO

- 64 Track capability, 8 Track simultaneous recording
- Graphic & Event list windows for detailed editing & control
- On-screen 'Master Faders' for mixing ease
- Simple capable with 'Cue List Editor' for professional synchronization

FROM LEAD SHEETS TO ORCHESTRAL SCORES!

### PASSPORT ENCORE

- Intuitive, easy to use graphic interface with real or step time input
- Transcribe from MT Pro or import MIDI files from other sequencers
- Up to 64 staves with support for Lyrics, Percussion & Guitar tablature
- Dynamic markings, Repeats & Tempo changes reflected in MIDI playback
- Publishing quality print-out for a truly professional look. Supports EPS export

Please call Musicware for the name of a dealer near you. Demo disks available. Dealer inquiries welcome.

**MUSICWARE DISTRIBUTORS INC.**  
641 Caledonia Road, Toronto, Ontario  
TEL (416) 785-3311 • FAX (416) 785-6416

## Multimedia on Your PC

*Continued from page 28*

er animated presentations (of course, a VHS videotape is a great way to deliver presentations, too), while a Mac is a better choice to build them.

There's plenty of software and hardware available for both tasks on both platforms.

### Specifics

Despite my complaints and reservations about many of the above-mentioned products, I have used a large number of multimedia tools over the past few months, while researching this article. Here are my conclusions.

### PC Multimedia:

**Best Bet:** development of business presentations.

### Hardware:

Look for a PC (pre-configured, if possible), equipped with the following:

- Sound Blaster Pro or Sound Blaster 16/ASP-compatible sound card. Although these are not the best sounding cards on the market, they are widely supported.
- A/C-powered speakers — preferably with two separate inputs, each with independent volume control. Recommended: Altec Lansing
- double-speed, Photo CD-compatible CD-ROM drive. Drives equipped with an SCSI interface are faster, but cost a little more. Recommended: top-of-the-line drives from Toshiba, Sony, Texel, NEC, Teac, Panasonic, Apple.
- Video digitizer with on-board image-compression implemented in hardware. The video digitizer should not require the use of a "VGA Feature Connector." Recommended:
- if you want to create video tapes, you will minimally require a video card or box that specifies NTSC- or (even better) SVHS-compatible output. Note that this does not necessarily imply that it will be broadcast quality video output — or even close. Recommended: Aver VideoKey.

### Recommended Software:

- MS-DOS 6.2 (PC) - for PC users who favor simplicity over power
- or OS/2 2.1 (PC) — for PC users who favor power over simplicity and have a multimedia hardware configuration known to be compatible with OS/2.
- Windows for Workgroups 3.11 (PC) - faster disk access than Windows 3.1, integrated fax services, improved file manager and other enhanced features over Windows 3.1
- CorelDRAW 4.0 (PC) — a good all-in-one graphics package, including animation, presentation, charting, clip art, fonts, paint and draw functions, etc.
- Adobe Premiere 1.0 (PC) or 3.0 (Mac) — for digital video editing.
- Adobe Photoshop 2.5 (Mac & PC) — for digital still-image manipulation.
- Asymetrix Toolbook (PC) — for creating interactive multimedia presentations. Runs somewhat slowly.
- HyperCard or SuperCard (Mac) — either title is a good choice for prototyping multimedia presentations. SuperCard is more capable than HyperCard, but runs more slowly.
- Macromedia Director. Expensive, complicated, but the de facto standard tool for building interactive animations on the Macintosh for delivery on Mac and Windows platforms.
- Passport Producer and Producer Pro — my pick for best Mac development tool for multimedia, especially if you are interested in animations with MIDI and/or SMPTE synchronizations.

If you are serious about broadcast-quality video output and/or production, here are some of the leading contenders in the area.

- Video Toaster 4000 (Amiga 4000)
- FAST Video Machine (PC and Mac)
- Avid Media Composer (Mac)
- Radius VideoVision Studio (Mac)

### Other reading:

- Instant Multimedia for Windows 3.1 is a book/2-disk set by Kris Jamsa. The 416 page book retails for C\$37.95.
- The Desktop Multimedia Bible by Jeff Burger is a must for people interested in developing multimedia applications or presentations. Paperback, 635 pages, \$42.95 (Addison-Wesley). ■

## Presentations

*Continued from page 24*

make a dramatic point is ok, but avoid using it consistently on all screens.

Color is also ideally suited to establishing continuity and differentiation in a presentation. It can link common thoughts and messages or reinforce hierarchical relationships. Picture a presentation that is pitching several different product lines. Each product line is given its own color scheme. When a new color scheme is encountered, it signals to the audience a new product line is being presented.

Colors make subtle, subconscious state-

ments to different audiences. Red is intense. Blue is loyal. Black is formal. Gold is rich. White is pure.

Color is often used to evoke certain reactions in people, such as:

- Red:** danger, stop, excitement, hot
- Dark Blue:** stable, calm, trustworthy, mature
- Light Blue:** youthful, masculine, cool
- Green:** growth, positive, organic, go
- White:** pure, clean, honest
- Black:** serious, heavy, death
- Gray:** integrity, neutral, cool, mature
- Brown:** wholesome, organic, unpretentious
- Yellow:** emotional, positive, caution. ■

## Where to Get Making Great Presentations

MINNEAPOLIS, MI — The Ask Me Multimedia Center has a multimedia program called SST— Super Show & Tell — along with the book, *Making Great Presentations On Your PC*. SST is a multimedia presentation tool for the entry-level enthusiast.

The product runs under Windows 3.1 and enables PC users to create presentations quickly, using text, pictures, animation, sound, and live-motion video.

Ask Me boasts that, using Super Show & Tell, any person with a basic understanding of the Windows environment can create a useful multimedia presentation within 60 minutes. The software and the book are available directly through Ask Me. List price is US\$299. ■

Contact: Ask Me, 612-531-0603; fax 612-531-0645

# LANCE ELECTRONICS Inc

WILL SHIP ANYWHERE IN CANADA  
FOR OUT OF TOWN ORDERS CALL  
**1-800-661-2319**

## BUILDING YOU THE FASTEST VESA SYSTEMS

### MOTHERBOARDS

|                                 |               |
|---------------------------------|---------------|
| <b>486-40MHz,w/CPU!</b>         | <b>\$ 189</b> |
| <b>4C87 MATH CO-PRO ADD</b>     | <b>\$ 60</b>  |
| AMD486DX-66 VLB 128k, w/CPU     | \$ 768        |
| 486DX-xx VLB, 128k, Ami         | \$ 149        |
| 3/486DX-xx VLB, 128k Ami        | \$ 159        |
| 486DX-xx EISA/VLB 256K AWARD    | \$ 399        |
| 486DX-xx VLB,AMI, SIS CHIP 256K | \$ 179        |
| <b>386SX 40MHz</b>              | <b>\$ 109</b> |

### SOUND BOARDS

|                         |        |
|-------------------------|--------|
| GRAVIS ULTRASOUND       | \$ 169 |
| GALAXY NX-PRO 16        | \$ 239 |
| PRO AUDIO SPECTRUM      | \$ 299 |
| ATI STEREO F/X          | \$ 119 |
| SOUND BLASTER 16 CD ASP | \$ 309 |
| ATI STEREO F/X--CD      | \$ 149 |

### CD-ROMS & TAPE DRIVES

|                               |               |
|-------------------------------|---------------|
| MITSUMI DOUBLE SPIN           | \$ 299        |
| PANASONIC DOUBLE SPIN         | \$CALL        |
| NEC CRD-74 280ms SCSI         | \$ 599        |
| TOSHIBA 200ms SCSI            | \$ 549        |
| SUMMIT SE305 IDE -Tape        | \$ 398        |
| <b>ARCHIVE Python 4mm Dat</b> | <b>\$ 998</b> |
| IOMEGA TAPE250                | \$ 279        |
| COLORADO JUMBO 250            | \$ 229        |

### CONTROLLERS

|                              |         |
|------------------------------|---------|
| AT IDE MULTI I/O             | \$ 24   |
| HIGH SPEED AT IDE I/O 2P     | \$ 79   |
| HIGH SPEED SERIAL 2S         | \$ 49   |
| ADAPTEC 1542C KIT SCSI       | \$ 369  |
| ADAPTEC 1542C BOARD SCSI     | \$ 279  |
| ADAPTEC 1522 SCSI BOARD      | \$ 119  |
| ADAPTEC 1522 KIT SCSI        | \$ 199  |
| ADAPTEC 2742 KIT EISA SCSI   | \$ 549  |
| DPT SMART CACHE III ISA SCSI | \$ CALL |

### SOFTWARE

|                           |              |
|---------------------------|--------------|
| <b>CANTAX FOR WIN..</b>   | <b>\$56</b>  |
| <b>CANTAX FIR DOS</b>     | <b>\$56</b>  |
| <b>HOMETAX FOR WIN..</b>  | <b>\$39</b>  |
| <b>HOMETAX FOR DOS</b>    | <b>\$39</b>  |
| <b>WP 6 FOR WIN. UPG.</b> | <b>\$139</b> |
| <b>WP 6 FOR WIN TRADE</b> | <b>\$169</b> |
| <b>MS WORD 6 UPGRADE</b>  | <b>\$126</b> |
| <b>MS WORD 6 TRADEUP</b>  | <b>\$159</b> |
| <b>MS EXCEL 5 TRADEUP</b> | <b>\$159</b> |
| <b>MS EXCEL 5 UPGRADE</b> | <b>\$126</b> |

### HARD DRIVES

|                                     |   |
|-------------------------------------|---|
| <b>WD CAVIAR 340M, IDE</b>          | <b>\$ 388</b>                               |
| <b>WD CAVIAR 425M, IDE</b>          | <b>\$ 499</b>                               |
| SEAGATE 3144A, IDE 130mb            | \$ 239                                      |
| SEAGATE 3290A, IDE 260mb            | \$ 299                                      |
| SEAGATE 3390a, IDE 340mb            | \$ 419                                      |
| SEAGATE 452M, IDE                   | \$ 549                                      |
| <b>BARRACUDA The fastest drives</b> | <b>in the world call for more info.....</b> |
| TOSHIBA 3.5" FLOPPY DRIVE           | \$ 52                                       |
| TOSHIBA 5.25" FLOPPY DRIVE          | \$ 58                                       |

### VESA-LB VIDEO CARDS

|                           |        |
|---------------------------|--------|
| Cirrus Logic 1M-2M        | \$ 146 |
| WD 1M -2M , C33 ChipSet!! | \$ 189 |
| S3, VLB, FASTI            | \$ 182 |
| ATI Ultra Pro 2M , VLB    | \$ 428 |
| #9 GXE 2MB VLB VRAM       | \$ 499 |

### OTHER SPECIALS

|                               |               |
|-------------------------------|---------------|
| <b>OLIVETTI 150W INKJET</b>   | <b>\$ 379</b> |
| HP-DESKJET 500                | \$ 399        |
| HP DESKJET 550C               | \$ 810        |
| INTEL 14,4 FaxModem Int.      | \$ 269        |
| USRobotics 14,4 FaxModem      | \$ 239        |
| <b>ZOLTRIX 24/96 S/R INT.</b> | <b>\$ 49</b>  |
| 3.5" DSHD FLOPPY DISKS /10    | \$ 6.99       |

### KEYBOARDS & .....

|                              |         |
|------------------------------|---------|
| DATAWARE XT/AT BILINGUAL     | \$ 26   |
| FUJITSU JUNIOR PRO           | \$ 39   |
| FUJITSU PROFESSIONAL         | \$ 77   |
| Z-NIX SERIAL MOUSE 3 BTN     | \$ 19   |
| 486 CPU COOLING KIT          | \$ 19   |
| 3.5" FLOPPY DRIVE BRACKET    | \$ 5.99 |
| 3.5" HARD DISK STEEL BRACKET | \$ 5.99 |
| OKILASER 400E                | \$ 689  |
| OKILASER 410E 600DPI 2MB     | \$CALL  |
| 1x 9 70ns SIMM MEMORY        | \$ CALL |
| 387-40MHz CO-PROCESSOR       | \$ LOW  |

### MONITORS

|                                   |               |
|-----------------------------------|---------------|
| <b>POWERII 17".26,FLAT-SQ.</b>    | <b>\$ 989</b> |
| <b>SVGA 17" 1280X1024 N.I. LR</b> | <b>\$1150</b> |
| SVGA 15" 1280x1024 N.I. LR        | \$ 549        |
| SVGA 14" 1280x1024 N.I.           | \$ 379        |
| SVGA 14" 1024x768 N.I.            | \$ 339        |
| SVGA 14" 1024x768 INT             | \$ 319        |
| VGA 14" PAPER WHITE               | \$ 149        |

CALL FOR OTHERS

## BASE SYSTEMS SPECIALS

\*\*\*\*\*

### 486-40MHz SYTEM

ISA BUS 128K CACHE  
MINITOWER/DESKTOP  
1.44 HD FLOPPY DRIVE  
2 SER/ 1 PAR / 1 GAME  
101 ENHANCED KB  
1MB SVGA VIDEO  
14" SVGA COLOUR

FREE MOUSE FREE MOUSE FREE MOUSE

**\$ 699**

486DX33MHz VLB 128K

### INTEL INSIDE

MINITOWER/DESKTOP  
1.44 HD FLOPPY DRIVE  
2 SER/ 1 PAR / 1 GAME  
101 ENHANCED KB  
1MB SVGA VIDEO  
14" SVGA COLOUR

FREE MOUSE FREE MOUSE FREE MOUSE

**\$ 999**

## JUST ADD MEMORY & HARD DISK

FEATURING UPGRADES WHILE YOU WAIT  
CUSTOM CONFIGURATIONS - FINEST COMPONENTS - CALL FOR LOWEST PRICING

## PLANTRONICS

World Leader in Telephone Headsets



ASK ABOUT OUR NEW  
COMPUTER MODEM  
HEADSETS

CALL  
FOR  
PRICING

### Mirage® - All Day Comfort



Modular headsets for phones  
with unpluggable handsets

SHARE 3 DEVICES ON ONE LINE  
WITH SEPARATE NUMBERS!

**\$99.95**

**Ring-ID**  
STATIC RING IDENTIFIER

**\$99.95**

#### FEATURES

- Works with IDENT-A-CALL service.
- New, super accurate, static design
- LED line activity indicators
- Built-in phone SURGE SUPPRESSOR
- Handles THREE separate numbers
- No need for separate line for FAX
- Line lock out feature
- No setup required; Just plug it in

THREE YEAR LIMITED WARRANTY

Made in Canada

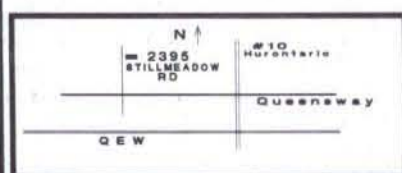

**CALL (905) 566-8325**  
**FAX (905) 566-0812**

OUT OF TOWN CALL 1-800-661-2319

2395 STILLMEADOW RD MISSISSAUGA

PRICES ARE CASH DISCOUNTED -/- SUBJECT TO CHANGE WITHOUT NOTICE -/- MASTERCARD ACCEPTED \*\* SOME QUANTITIES ARE LIMITED \*\*

# MAKE TAX TIME LESS TAXING.

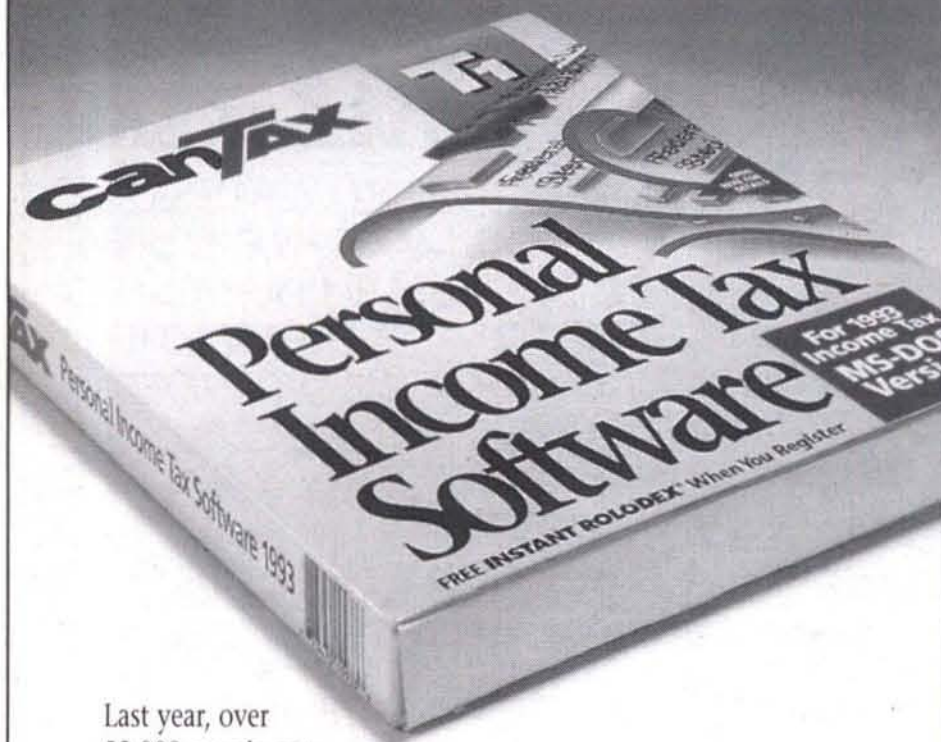

Last year, over 52,000 people got the best return for their money with CANTAX T1 personal tax software for DOS. This year, what's new to Canada's Number One Income Tax Software line is even less taxing.

**New CANTAX T1 for Windows™** lets you view, re-size, move and access multiple forms instantly. Simply enter figures from tax information slips. Canada's most comprehensive tax software does the rest.

**The New Jump Start feature** prepares 1993 provincial and federal taxes in minutes (up to 15 individual returns in all) for any province or territory (except Quebec provincial taxes).

**A New Built-In Tutorial plus Step-by-Step Checklist** guide you easily through over 50 Revenue Canada approved forms and schedules. Self diagnostics ensure accuracy. **Over 1600 HELP screens** offer money saving tips and options for carrying forward yearly details and creating tax summaries of "what if" scenarios.

**Complete, approved returns** can be printed on a dot matrix printer. **Exact duplicate returns** can be printed on a compatible laser printer.

**Why tax yourself more? Call 1-800-265-3800** for the name of your nearest CANTAX T1 retailer.



# canTAX

Canada's Number One Income Tax Software

CANTAX, 200 - 6130 3rd Street S.E., Calgary, Alberta T2H 1K4

MS-DOS™, Microsoft® Windows™, Quicken™ and Microsoft® Money™ are registered trademarks of their respective owners.

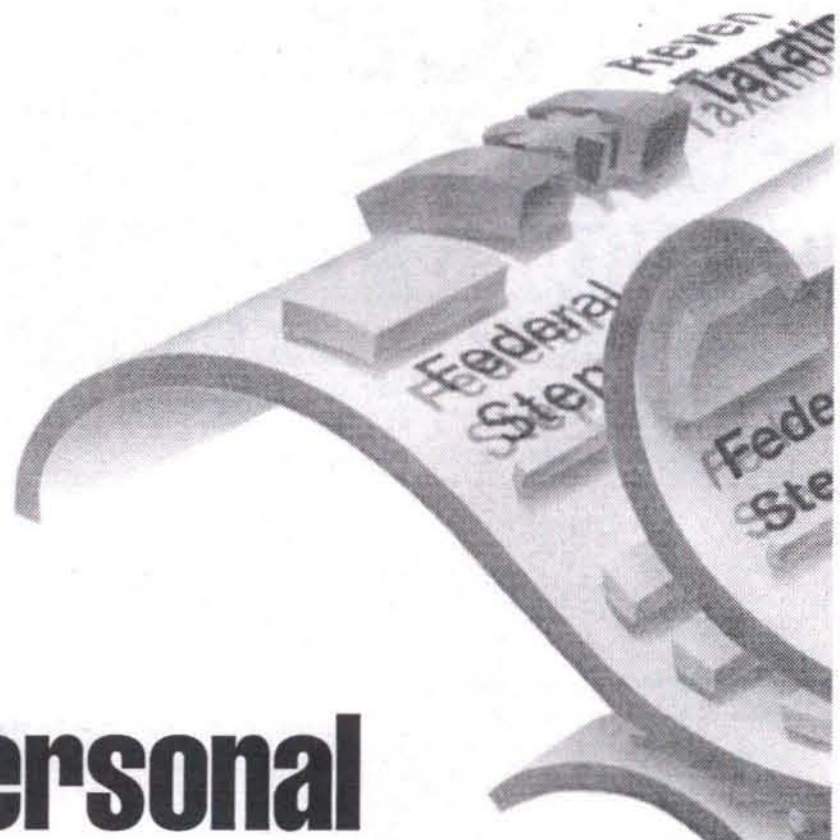

## Personal Tax Software

BY FRANK HILLIARD

*The pain of filing your income tax may not be as bad if there's a really slick program to help you fill out the forms.*

Nobody likes paying taxes, but almost everyone who reads *The Computer Paper* likes trying out new software. That was the idea I had when I sat down to compare three popular tax preparation programs; CanTax, HomeTax, and WinTax and a fourth you may not have heard about, Tax Made Easy.

The other thought that crossed my recession-weary brain was that maybe one program would find a better tax break than the others, some little known part of the Code that would save me a few bucks.

If that's what you're hoping for, you'd better go out and hire a Chartered Accountant, because these programs are required by Revenue Canada to come up with the same answers. They may help you get your refund faster by letting you file early, but that's it.

The difficulty was in making the comparison fair, because each year tax preparation companies come out with improved versions and not all the new ones were on the market when this was written. As a result, I looked at all four programs for last year (1992) as well as WinTax and HomeTax for this tax year (1993).

Not surprisingly, since they're all basically doing the same thing, they have quite a few operating features in common. For example they all produce regulation output, cross-enter data where necessary, make sure your form and your spouse's are optimized for the best results and have an override function.

What makes them a joy to use is that after you enter the figures, they do the work. Among other things, you can forget about figuring out the Provincial Income Tax sec-

tion. This little bit of pencil pushing is handled by all the programs instantly, allowing you to get to the refund box (item 484) in double quick time.

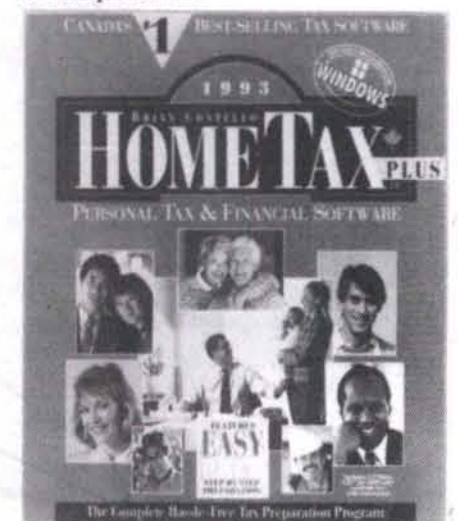

**HomeTax**  
Brian Costello HomeTax Plus is published by Informatrix 2000 Inc., a member of the Soft-key group of companies in Toronto. It comes with two floppy disks, a 144 page manual and occupies 2 MB of disk space.

Like three of the four reviewed, it's a DOS program, and uses ASCII graphics, so it looks and feels rather like a late model DOS word processor, such as MultiMate, with drop down menus from an option list across the top of the screen. There's nothing wrong with this from a practical point of view, but it will strike confirmed Windows users as dated in appearance.

Once the number crunching begins, HomeTax shines. The four pages of the T1

# BRIAN COSTELLO HOME TAX PLUS™



## CANADA'S BEST SELLING PERSONAL TAX PREPARATION & FINANCIAL SOFTWARE

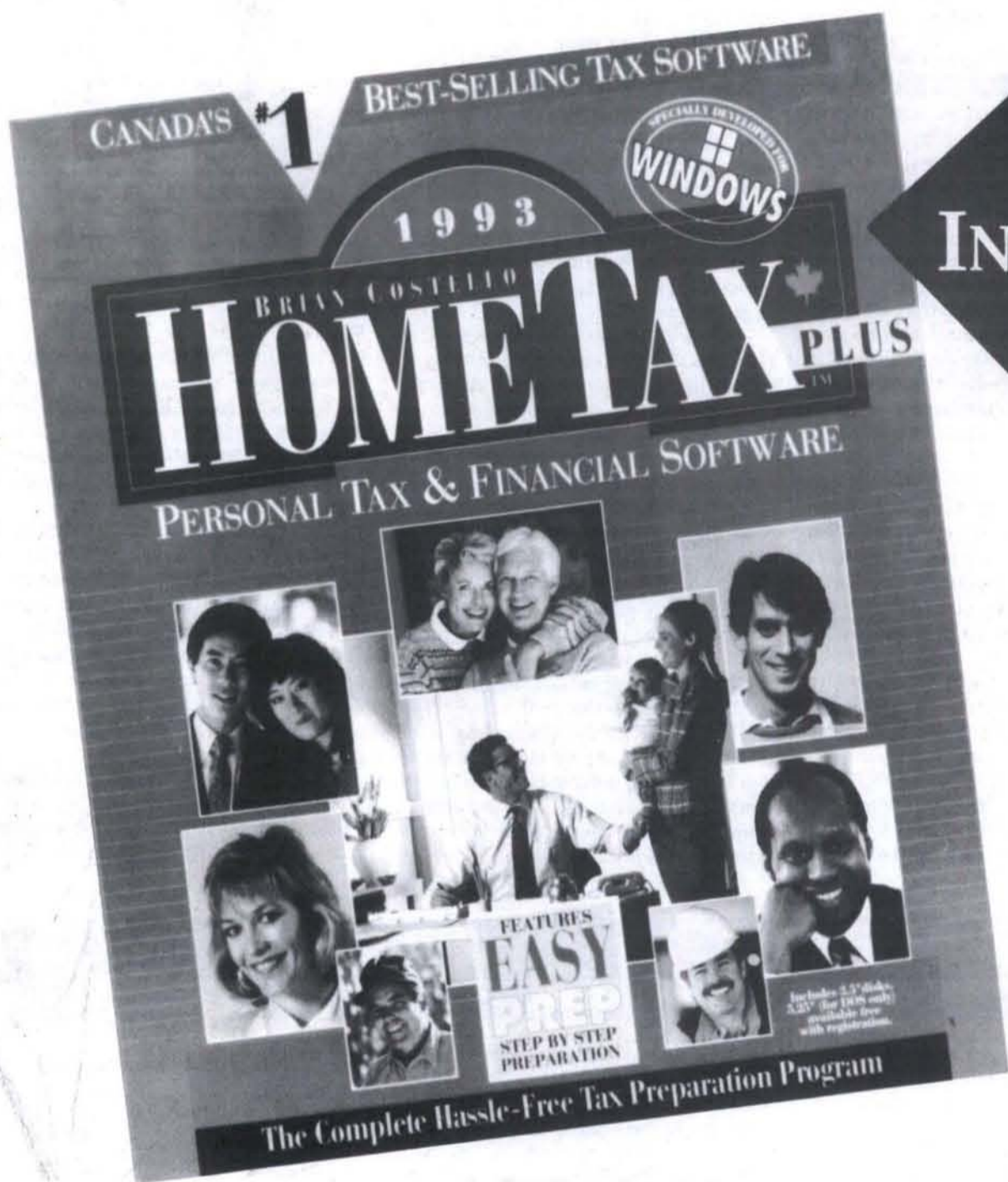

**NOW AVAILABLE  
IN DOS, WINDOWS\*  
& MACINTOSH**

Available  
At The Following  
Fine Retailers

▼  
BUSINESS DEPOT

—  
CLUB BIZ

—  
COLES

—  
COMPUCENTRE

—  
FUTURE SHOP

—  
PRICE CLUB

—  
RADIO SHACK

—  
SMITH BOOKS

—  
WISE GUYS

*"I find HomeTax Plus the easiest program to use and the question and answer format helps to ensure you don't miss any deductions."*

**RICHARD MOROCHOVE ~ *The Toronto Star***

\* Windows & Mac versions available Feb 1, 1994.

You may purchase DOS version at retail and receive Windows update FREE with registration card.

# dataTAX

By Legendary Design Technologies

The **ONLY!** DOS tax program that uses graphics and a mouse, but does **NOT** require Windows!

Requirements: 640k and a hard drive. Works with virtually any colour or monochrome monitor and printer. Mouse supported but not required.

\*Also available for the Amiga\*

- Government approved; print & sign!
- What-if? tax planning
- Yearly updates available
- Main/Spouse return at the same time



Only \$39.95, taxes and shipping included if ordered by March 1.

Available from:

Canada Computerware  
100 City Centre Drive  
P.O. Box 2201  
Mississauga, ON L5B 3C7  
Orders: 1-905-821-9927  
Inquiries: 1-519-753-6120  
Toll Free Orders: 1-800-263-7820

General form are set up as four screens with the same numbered boxes as those put out by Revenue Canada. An "Interview" option, walks you through the form, asking questions and providing screens as you go along. The supporting material, such as your T4 Slip, are separate screens accessed from a Main Menu. An override key, <F9>, allows you to bypass the HomeTax calculation if there's a disagreement.

HomeTax will import Quicken data directly, supports 80 printers and includes a financial planning function and a calculator that will perform metric conversions. Perhaps its best feature is its "Planif" function, a tax alternatives worksheet. This shows the basic entries on the T1 tax form for three different scenarios side-by-side. If you're considering an RRSP contribution, you can see exactly how it's likely to affect your bottom line.

Altogether, HomeTax is a solid, comprehensive product that has an excellent planning and scenario building capability. Any difficulties with its DOS interface are easily overcome with its Interview function and easy to understand manual.

New in the 1993 Edition: The Interview function has been improved and renamed "Easy-Prep" and the box says the disk space needed is 4.5 MB. If you buy it, check to see if you have an "Early Bird" version that requires you to send away for a free upgrade to the production release. A Windows version may also be in the stores when you go to look, but was not available for review.

### Cantax

Cantax personal income tax software, published by Cantax in Calgary, is one of two major offerings produced in Alberta, and is very popular on the west coast. A question I left on a BBS in Victoria, showed CanTax was easily the most popular program among board members.

It comes with two floppy disks, a 90-page guidebook, and 100 page-tax summary and occupies about 2.5 MB of disk space. Like HomeTax it has pull down menus, but it differs in that, it's laid out in scrollable lists. The main one is the Index of Information Required, which puts all the forms, schedules and other calculations in a logical order from

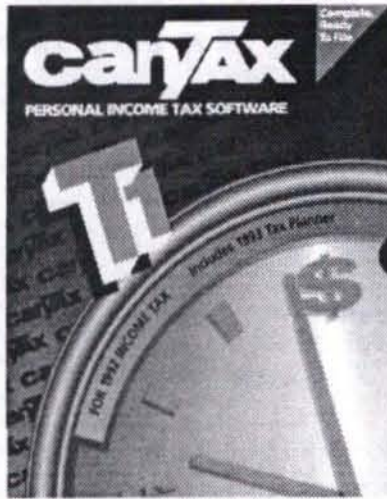

top to bottom. Each line can be expanded into a form and then reduced again.

The second key point about CanTax is that it has a built-in diagnostic function that offers warnings, and reminders of where you should sign and what you should attach to your return. If you miss claiming a standard tax credit for example, the diagnostic screen will point this out.

Throughout, there is a context sensitive help function under the <F1> key when used on an entry field. In other spots, you need to use <Shift-F1> to get tax advice or <Ctrl-F1> to get program help.

CanTax also has its own Bulletin Board at (403) 255-3589 for software support, tips and tricks, which I thought was a good approach.

### Tax Made Easy

This is the David among the Goliaths. Tax Made Easy, produced by La Motte Enterprises Inc., 2614 Bridge St., Victoria, BC V8T 4S9, comes on one diskette and has a user guide that is printed on one piece of paper.

Despite this, or perhaps because of this, it's remarkably easy to use. Just insert the diskette and the program will run right off the floppy. The screens are very plain, but the questions are logical and straightforward and the information easy to fill in.

Navigation is simple. As you move down the list, you fill in the highlighted fields, or skip them if they don't apply. Make a mistake? Delete the offending figure and enter it again. Any problem? Just look at the bottom of the screen for what to do next.

By ignoring most of the more obscure filing forms and including all eight schedules needed to produce a T1 personal income tax return, TAX Made EASY really does make it easy. It doesn't have much help, a manual, a calculator or any bells and whistles, but it does the same job as the others and takes less time to do it. It also prints the whole form out in a Revenue Canada approved style that you can send in with your T-slips.

Tax Made Easy is available for B.C., Alberta and Ontario at \$39.95.



### WinTax

WinTax is the other Alberta-based tax preparation software, produced by WinTax Software Corporation in Edmonton, which is owned by Intuit, the makers of Quicken. This is the killer application of the four, a sleek, comprehensive, Windows program that, this year, is really, really cheap.

Most tax software, except Tax Made Easy, retails for between \$50 and \$60. WinTax will be going on the shelf for \$29.95 and will contain a manufacturer's cash rebate coupon for \$20, making the effective price \$9.95!

WinTax comes on one floppy, has a 104 page manual and occupies about 2 MB of disk space. It's installed from inside Windows and sets itself up in its own WinTax group.

Once a new file is opened, you see wonderful exact reproductions of the Revenue Canada tax form and get a guided tour from

## TELL ADVERTISERS YOU

SAW THEIR AD IN



# ACM COMPUTER SYSTEM

4800 Sheppard Ave. East, Unit 109  
Scar., ON M1S 4N5 BBS Support: 412-0932

Tel: (416) 298-6646  
Fax: (416) 298-6302

### SUPER SPECIAL: Pentium 60 MHz-PCI System \$3,300

- Intel 60MHz Pentium CPU
- True 64-bit data path
- 8MB RAM, max: 128MB
- 256KB processor cache
- 3.5" 1.44MB diskette drive
- 340MB hard disk
- 4 ISA, 2 PCI, 1PCI/ISA slot
- MINI tower case
- ATI Ultra + Acc. /2M RAM
- 101 Enhanced Keyboard
- Microsoft Compatible Mouse
- 14" SVGA NI .28dp monitor

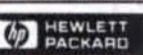

Authorized Retailer

- HP DeskJet 310 Ink Jet \$415
- HP DeskJet 500 Ink Printer \$395
- HP DeskJet 500C Ink Printer \$535
- HP DeskJet 550C Ink Printer \$799
- HP LaserJet 4L 1Mb Ram \$929
- HP LaserJet 4P 2Mb Ram \$1,379
- HP LaserJet 4ML, 4MP, 4, 4M\$Call
- HP ScanJet iicx Scanner \$1,359
- HP ScanJet Iip Scanner \$1,059

• Ink & Toner Cartridges Available

### 486DX-33 Intel VESA SYSTEM \$1,599

- 128K Cache
- Pentium P24T Socket
- 4 MB Fast Memory (70ns)
- 270 MB Hard Drive
- 1.44 M Floppy Drive
- SVGA NI 0.28 Monitor
- 32 bit LB Window Accelerator 1M
- 32 bit LB IDE I/O (2S, 1P, 1G)
- Mini Tower Case 200W PS
- 101 Enhanced Keyboard
- Free Microsoft Compatible Mouse
- 2 Years Labour & 1 Year parts Wty

Peace of mind Solutions to your needs and more... in ONE box. Take a PS/1 home today.

Look! Complete lineup of PS 1 at LOW prices

- IBM PS/1 Model E49 \$1645
- IBM PS/1 Model D48 \$1789
- IBM PS/1 Model E26 \$1595
- IBM PS/1 Model E28 \$1949
- IBM PS/1 Model E32 \$2295
- IBM PS/1 Model E63 \$2669
- IBM PS/1 Model E67 \$3099



### IBM PS/1 E92 Multimedia \$2,348

- 486SX-25MHz
- 4Mb Ram, 170Mb HD
- 1.44M Floppy Drive
- 1 Meg LB Video
- 14" SVGA Colour Monitor
- Modem & Mouse
- SB16 & Double Speed CD-ROM
- Windows 3.1, Dos 6.0 & MS Works 2.0

### Components Galore

- Multimedia**
- SB Discovery 8/16 \$509/\$599
- Panasonic CR562 DS CD-ROM \$289
- ATI CD Sound Dimension \$349
- SB16 MultiCD/MultiCD-ASP Sound Card \$229/\$279
- SB16 SCSI-II ASP Sound Card \$295
- Drives**
- Maxtor 345 Meg \$389
- Western Digital 420 Meg Hard Drive \$469
- Western Digital 540 Meg Hard Drive \$649
- Toshiba 1.44/1.2M Floppy Drive \$53/\$63
- Modems**
- USRobotics 14.4 Internal/External \$209/\$239
- Boca 14.4 Internal/External \$169/\$199
- Monitors**
- Sony GDM-17SE \$1599
- NEC 4FGe-ip \$939
- CTX 1561 15" LR \$499
- 14" NI SVGA \$325



Member of Better Business Bureau

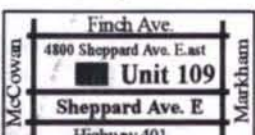

# This year, do your taxes the easy way... with WinTax.

**Special Introductory Offer!**  
Try WinTax today  
and get a \$20.00 rebate!  
It's like getting an early  
tax refund!

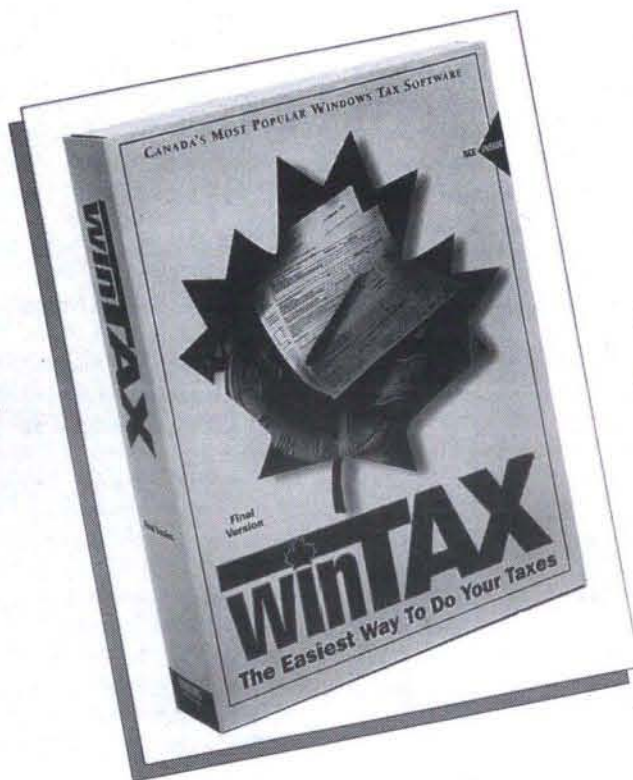

*"WinTax is the killer  
application of the four, a  
sleek, comprehensive  
Windows program..."*

*Frank Hilliard  
The Computer Paper*

WinTax is Canada's first personal tax software designed for Windows™. Now you can see exact replicas of Revenue Canada-approved forms on your screen and print them on your printer!

**Easy To Use!**

WinTax includes over 50 Revenue Canada-approved forms. Plus, extensive help is available to assist you every step of the way.

**Fast!**

WinTax recalculates your return instantly whenever you change a number, saving you valuable time.

**Accurate!**

You can file your tax return with confidence, because WinTax checks your return for accuracy-- alerting you of any errors and even offers tax savings suggestions.

**Guaranteed!**

If you can't complete your tax return with WinTax, we'll refund your money -- guaranteed!

To order WinTax for \$29.95 (plus \$6.50 shipping and applicable sales tax)

call  
**1-800-268-6434.**  
ext.100

**winTAX**  
©1994 All rights reserved. The WinTax logo is a trademark of WinTax Software Corporation. All other trademarks are the property of their respective owners.

a help function called "Assist New." When this option is enabled, WinTax will explain the recommended method for preparing your return, invoke the Information Slips dialogue automatically, and then display a help window with information on what not to forget to enter, the different kinds of income and expenses and where they go, and a brief description of each of the forms.

There is context sensitive help, a unique "Tax Summary" window that floats on top of the forms and much, much more.

It's so sophisticated, a fail-safe help screen pops up after the print dialogue box, for one last chance to get it right the first time.

New in the 1993 Edition: The "Head Start" version of WinTax has an attractive toolbar across the top of the screen, faster printing speed, improved validation features with two levels of warning messages and a much smaller file size. In addition, the production release will contain a new technology called the "EasyStep" system that will guide new users through every step of the tax filing process.

Whether you want financial planning, user endorsements, bare bones or ultra sophisticated, there's quite a field to choose from—and every one of them is easier than doing it with a pencil. ■

### OCEAN SYSTEM

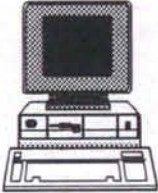
|  |  |
|--|--|
| <p><b>386DX33</b><br/><b>\$1040</b></p> <p><b>486SX25</b><br/><b>\$1080</b></p> <p><b>486SX33</b><br/>128K Cache<br/><b>\$1130</b></p> <p><b>486DX40</b><br/>128K Cache<br/><b>\$1320</b></p> <hr/> <p><b>VESA LOCAL BUS SYSTEM</b></p> <ul style="list-style-type: none"> <li>- VESA Local Bus SVGA 1MB RAM</li> <li>- 250MB Hard Drive</li> <li>- 4M Ram</li> <li>- 128K Cache</li> <li>- 1.2MB Floppy Drive</li> <li>- 1.44MB Floppy Drive</li> <li>- 2serial, 1parallel, 1game ports</li> <li>- 14" SVGA Non-Interfaced Monitor</li> <li>- 101 Keyboard</li> <li>- Mini Tower Case</li> <li>- MS compatible Mouse</li> <li>- IDE Controller</li> </ul> <p><b>486SX25</b>      <b>\$1350</b></p> <p><b>486SX33</b>      <b>\$1390</b></p> <p><b>486DX40</b>      <b>\$1580</b></p> <p><b>486DX2-50</b>    <b>\$1610</b></p> <p><b>486DX2-66</b>    <b>\$1770</b></p> <p><small>Prices are subject to change without notice.<br/>Warranty: Two years labour and one year parts</small></p> |  <p><b>VIDEO CARD-</b></p> <ul style="list-style-type: none"> <li>VGA 256K Ram \$ 35</li> <li>Trident SVGA 512K Ram \$ 50</li> <li>Trident SVGA 1M Ram \$ 85</li> <li>ATI XL24 SVGA 1M Ram (OEM) \$ 125</li> <li>ATI Ultra plus VESA Local BUS 2MB (OEM) \$ 350</li> <li>Cirrus Logic VESA Local BUS 1MB \$ 145</li> </ul> <p><b>PRINTER -</b></p> <ul style="list-style-type: none"> <li>Raven RP-2405 B / W \$260</li> <li>Raven RP-2406 color upgradeable \$290</li> <li>Raven LP-510 5ppm Laser 512K \$730</li> <li>Raven LP-530 5ppm Laser 1MB \$930</li> <li>Panasonic 1150 \$195</li> <li>Panasonic 2023 \$260</li> <li>Panasonic 2123 colour upgradeable \$300</li> <li>Samsung 24pin B / W \$195</li> <li>Canon BJ-200 Bubble jet \$380</li> <li>Canon BJ-230 Bubble jet \$530</li> <li>HP 4L Laser jet \$980</li> </ul> <p><b>MONITOR -</b></p> <ul style="list-style-type: none"> <li>14" Mono VGA \$145</li> <li>14" VGA 0.41dpi \$245</li> <li>14" SVGA 0.39dpi \$265</li> <li>14" SVGA 0.28dpi \$300</li> <li>14" SVGA 0.28dpi (NI) \$340</li> <li>15" SVGA 0.28dpi (NI) \$510</li> </ul> <p><b>HARD DRIVE -</b></p> <ul style="list-style-type: none"> <li>50 MB IDE \$ 170</li> <li>80 MB IDE \$ 200</li> <li>105 MB IDE \$ 220</li> <li>120 MB IDE \$ 230</li> <li>170 MB IDE \$ 260</li> <li>245 MB IDE \$ 300</li> <li>340 MB IDE \$ 430</li> <li>520 MB IDE \$ 830</li> <li>Conner 250M Tape Drive \$ 250</li> </ul> <p><b>MODEM -</b></p> <ul style="list-style-type: none"> <li>2400 Internal Modem \$ 50</li> <li>96/24 Internal Fax Modem \$ 65</li> <li>14/96 Internal Fax Modem \$ 175</li> <li>14/96 External Fax Modem \$ 230</li> </ul> <p><b>OTHER INTERFACE -</b></p> <ul style="list-style-type: none"> <li>IDE Controller I/O(2S, 1P, 1G) \$ 30</li> <li>VESA IDE Controller I/O (2S, 1P, 1G) \$ 45</li> <li>Game Card 2 Ports \$ 28</li> <li>Monochrome Card \$ 20</li> <li>Printer Card \$ 20</li> </ul> |
|--|--|



**OCEAN ELECTRONICS**  
825 Denison St. Unit 3, Markham, Ontario L3R 5E4  
Tel: (416) 946-8986 Fax: (416) 946-8990  
Mon. To Fri. 10:30 - 6:30 Sat. 10:30 - 4:00

# Other Tax Preparation Packages

## dataTAX

Legendary Design Technologies Inc. In Brantford, Ont. has dataTAX for the Amiga and also the PC.

The program presents on-screen graphic representations of the Revenue Canada Forms and also prints out look-alike forms on plain paper. The program will handle two returns simultaneously, so couples can calculate their returns at the same time.

An on-line calculator is included and results can be cut and pasted into the form. Calculation of deductions and refunds within the forms is performed automatically, and the values of a cell may be over-ridden to perform "what-if" analyses.

Suggested retail price is \$59.95 and yearly updates to registered users cost \$29.95.

Contact Legendary Design Technologies, 519-753-6120

## ProTax

Raspberry Software, 5284 Heritage Hills Blvd., Mississauga, Ontario L5R 3H2. Tel 416-507-9345, Fax 416-568-8323

## Quick Returns!

Contact: Ontek Development, 20 Wertheim Court, Unit 16, Richmond Hill, ON L4B 3A8, 905-764-1064, fax 905-764-7138

## Macintosh Tax Software

### MacTax Pro

MacTax Corp, 5284 Heritage Hills Blvd., Mississauga, Ontario L5R 3H2. Tel 416-507-9345, Fax 416-568-8323.

## GriffTax Macintosh

Colin Griffith & Associates Ltd, 120 Pineridge Road, Carp, Ontario K0A 1L0, Tel 613-839-5796, Fax 613-839-1764.

## RRSP Tracking Software

New this year is a piece of software called RRIFMETRIC is designed to help in RRSP accumulations and withdrawals. It covers both the RRSP contribution and withdrawal phase in one screen. You can change each number year by year. You can also chart large withdrawals for major expenses, and deal with integrating pensions and other income. The program allows you to integrate tax-sheltered and other incomes into one income stream. Results can be shown as taxed, or untaxed amounts and displayed in tabular or graph forms.

Contact: FIMetrics Systems Ltd., 1240 Eldon Road, North Vancouver, BC, V7R 1T6, Tel 604-988-6585.

## GriffTax

Colin Griffiths And Associates of Carp Ont. is offering GriffTax for Macintosh computers. The company offers variations of the program tailored to a number of markets — individual, individual (Quebec version), corporate and trust. The program also supports Revenue Canada's E-filing.

The program allows several returns to be open at the same time, thus allowing automatic transfer of amounts between spouses, or transfer to a provincial return for the same taxpayer.

The program uses on-screen forms and also includes on-line help as well as the Revenue Canada guide.

The Personal version of GriffTax sells for \$69 or (\$99 for the Quebec edition).

Contact: GriffTax, 613-839-2455, Fax 613-839-1764

# NOTEBOOK BLOWOUT

FREE HOME ALARM WITH "LOWEST PRICE GUARANTEED"  On the Spot Financing  Best Rates Leases  Visa / Mastercard / Amex

**IMPULSE**  
486 4/120  
**\$1699**



**WINDOWS / DOS**  
4 Megs Ram, 120 MB Hdd  
10" Monochrome

**AST.**  
486 25  
**\$2099**



120 Hdd With Cellular ready fax modem \$2499  
4 Megs Ram, PCMCIA  
Dos 6.0, Windows 3.1

**ARRIVA**  
**COLOUR 486-25**  
**\$2399**



1 Yr Warranty  
4 Megs Ram, 120 MB Hdd  
Trackball, Colour Screen

| NOTEBOOK SPECIALS        |           |
|--------------------------|-----------|
| AST 486 Bravo            | \$2099.00 |
| Compaq 486 Colour        | \$3449.00 |
| Texas Instruments 486    | \$1999.00 |
| Ultralite Versa DX40 COL | \$5699.00 |
| Toshiba T1900            | \$2199.00 |
| AST Active Matrix        | \$4499.00 |
| Samsung 486 4/120        | \$1799.00 |

MEMORY, HARD DRIVES, FLOPPY MODEMS, PCMCIA, SOFTWARE

| ON THE SPOT FINANCING   |        |
|-------------------------|--------|
| Impulse 486 33          | \$1699 |
| Toshiba T4600 Active    | \$5699 |
| Toshiba T1950           | \$2999 |
| TI Win 4000 (D) SX 25   | \$2049 |
| TI 4000e (D)SX25 Colour | \$2599 |
| TI 4000e (D)DX50 Colour | \$4395 |

all prices have been cash discounted

**SHORT TERM RENTALS**

# THE NOTEBOOK STORE

4495 Chesswood Drive  
North York, Ontario. **(416)630-5681**

FAX ORDER (416)630-2594      Watch for our 2nd Location

# The New World Of PC Spreadsheets

BY ALAN SALMON

As we move into the mid-1990s, the world of spreadsheets is taking a dramatic leap forward. With new products and significant upgrades to old favorites, number crunching is getting easier for the novice and more power and flexibility are becoming available for the advanced user.

The three major spreadsheet developers have each released new versions of these products. These include the Lotus 1-2-3 Release 4.0 for Windows; Borland's Quattro Pro 5.0 for both Windows and DOS; and Microsoft's Excel 5.0.

As well, two new products from Computer Associates will join the spreadsheet marketplace in early 1994. Visual 20/20 is a Windows version of the former Unix 20/20 spreadsheet. It will differ from other spreadsheet products in that it will be sold through value added resellers (VAR's) and targeted to companies that have a mix of PC, VAX, and Unix environments.

The second CA product, SuperCalc V for Windows, will provide the same functionality as the current SuperCalc V for DOS product. It represents Computer Associates' attempt to regain some of its lost market share in the spreadsheet world.

There is no question that Windows is

putting a lock on the spreadsheet market. With their graphical user interface, ease of use and advanced features, Windows spreadsheets are now a dominant force. While the DOS products will still co-exist for a number of years, and there will be upgrades to major products such as Lotus 1-2-3 for DOS, their days are clearly numbered.

### Into The Fourth Dimension

Without a doubt, multi-dimensional modeling software is an exciting world for spreadsheet users. Lotus Improv and CA-Compete go well beyond the three dimensional limits of traditional spreadsheets and these 4th dimensional products provide the ability to arrange spreadsheet views dynamically and allow the user to view data in new and revealing ways.

Rearranging a spreadsheet merely involves selecting a category and dragging it

486DLC33/128k \$929

2M RAM, 120M Hard Drive  
1.44M Panasonic Floppy Drive  
512K Trident Video Card  
14" .39 1024x768 Amazing Monitor  
IDE I/O Controller w/1P,2S,1G Ports

486DX33/128k \$1,578

486DXII66/128k \$1,868

4M RAM, 245M Hard Drive  
1.2M & 1.44M Panasonic Floppy Drive  
VESA Local Bus 1M Video Card  
14" .28 1024x768 Non-interlaced Monitor  
VESA Local Bus I/O Controller (1P/2S/1G)

All Systems come with:  
Mini Tower Case, 101 Enhanced Keyboard  
1 Year Parts & 2 Year Labor Warranty

### REPAIRS

VGA Monitor \$60 include parts & labor  
Printer, Fax Machine, UPS & Hard Drive .Call

**GHE inc. 905-479-4235**

1001 Denison St. Unit #1, Markham, Ont. L3R 2Z6



## Microview Systems



486DX33 \$ 1595

486DX2-66 \$ 1895

Intel CPU  
Built-in Math Co., 3 Vesa L.B. Slots, Opti  
256K Cache  
4MB Ram 70ns  
14" NI SVGA Monitor, .28dp  
Vesa L.B. SVGA 1MB Video Card  
210 MB IDE Hard Drive  
1.2 & 1.44 MB Floppy Drive  
Hard & Floppy Drive IDE Controller  
2S, 1P & 1G Ports  
Mini-Tower Case w/ 200w PS  
101 Enhanced Keyboard  
MS-Compatible 3-Button Mouse

Commodo CLR 433 \$1975

Intel 486DX-33MHz CPU  
Three VESA local bus Slots  
4MB RAM  
8k level-1 cache  
128 level-2 cache  
245MB hard drive  
1.44MB floppy drive  
Super VGA Monitor, 0.28dp  
1MB VESA video card  
Desk-top Case  
Commodo Mouse  
MS Works, MS DOS 6.2, Windows 3.1

Microsoft Serial Mouse (new Ver.) \$35

7725 Birchmount Road, Unit 43, Markham Tel: (905) 513-9922 Fax: (905) 513-1165

# OTA Notebook Centre

343 COLLEGE STREET · TORONTO, ONTARIO · M5T 1S5  
TEL (416) 921-1177 · FAX (416) 921-8664

**Canon PRINTERS** BJ10ev BJ300 BJ200 BJ330  
BJC600 only \$769  
CARTRIDGES: Black \$13.95, Colour \$15.95

**Panasonic FAX MACHINES** KX-90 KX-F190C KX-F110 KX-F250C  
PHOTOCOPIER FP-820

**SAMSUNG FAX MACHINES** FX-500 FX-505 FX-2200

**HP** HP 500, 500C, 550C  
HP Portable Printer  
HP LaserJet 4 & 4L

**Microsoft** HP 500, 500C, 550C  
HP Portable Printer  
HP LaserJet 4 & 4L

### AST Bravo Series

w/ DOS, Windows, Trackball, PCMCIA

| CPU       | RAM (MB) | HD (MB) | Price  |
|-----------|----------|---------|--------|
| 486 SX/25 | 4        | 80      | \$2245 |
| 486 SX/25 | 4        | 120     | \$2395 |
| 486 SX/25 | 4        | 170     | \$2575 |

### IBM ValuePoint

DESKTOP VLB SYSTEMS

|                         |        |
|-------------------------|--------|
| 486 DX/33 w/ 170 MB HD  | \$1795 |
| 486 DX/33 w/ 340 MB HD  | \$1945 |
| 486 DX2/66 w/ 170 MB HD | \$2095 |
| 486 DX2/66 w/ 340 MB HD | \$2245 |

**Systems include:** 4 MB RAM, DOS 1.2 MB Floppy Drive, 1 MB VLB SVGA card, IBM 101-key keyboard, Serial (2)/Parallel/Game Ports, Desktop/Mini-Tower Case. Monitor not included. Limited Quantities.

**1 YEAR ON-SITE WARRANTY**

### PIONEER-GEMINI

Two year warranty, built-in Trackball, Colour Available  
Following have 4 MB RAM and 120 MB Hard Drives  
CPU/Screen upgradeable, 1 MB video Local Bus

| CPU       | Price  | CPU        | Price  |
|-----------|--------|------------|--------|
| 486 SX/25 | \$2395 | 486 DX2/50 | \$2795 |
| 486 DX/33 | \$2695 | 486 DX2/66 | \$2995 |

### HYPERDATA

With 4MB RAM & 120 MB HD, DOS, Fax Modem, Trackball  
SCSI-2, Car Adapter, Carry Bag, Separate Number Pad

|            |        |                   |        |
|------------|--------|-------------------|--------|
| 486 SLC/33 | \$2295 | w/ Passive Colour | \$3395 |
|------------|--------|-------------------|--------|

### AST PowerExec Series

w/ DOS 6.0 and Windows 3.1 and Removeable Hard Drive

| CPU         | Video  | RAM | HD  | Price  |
|-------------|--------|-----|-----|--------|
| SL486 DX/25 | Mono   | 4   | 80  | \$2995 |
| SL486 DX/33 | Mono   | 4   | 200 | \$3695 |
| SL486 DX/25 | Colour | 4   | 200 | \$5695 |
| SL486 DX/33 | Colour | 4   | 200 | \$5895 |

**PowerExec Accessories**

Port Replicator ..... 179 NiMH Spare ..... 249  
4 MB Upgrade ..... 339 TrackBall ..... 139  
Leather Carry Case .... 149 NumPad ..... 129

### Impulse

Notebooks include DOS & Windows, Trackball  
All have 4 MB RAM and 120 MB Hard Drives

| Model     | CPU        | Display      | Price  |
|-----------|------------|--------------|--------|
| SubNote   | 486 SLC/33 | Mono         | \$2195 |
| CompuBook | 486 SLC/33 | 10" Mono     | \$1995 |
| CompuBook | 486 SX/25  | Dual Passive | \$2895 |
| CompuBook | 486 DX/33  | 10" Mono     | \$2295 |
| CompuBook | 486 DX/33  | Dual Passive | \$3295 |

### TOSHIBA

Notebooks w/ DOS & Windows, Trackball & Fax Modem  
Both have 4 MB RAM and 120 MB Hard Drives

| Model    | CPU                         | Price  |
|----------|-----------------------------|--------|
| T-1900   | 486 SX/25                   | \$2295 |
| T-1900C  | 486 SX/25 (Passive Colour)  | \$3295 |
| T-1950   | 486 DX2/40                  | \$3095 |
| T-1950CS | 486 DX2/40 (Passive Colour) | \$3895 |
| T-1950CT | 486 DX2/40 (Passive Colour) | \$4795 |

### Raven / Panasonic Notebooks

| Model   | CPU        | RAM (MB) | HD (MB) | Price  |
|---------|------------|----------|---------|--------|
| Flite 4 | 486 SLC/25 | 4        | 170     | \$2495 |

**Raven 24-pin Printers (unless noted)**

|                 |       |                 |       |
|-----------------|-------|-----------------|-------|
| RP-9105 (9 pin) | \$199 | PR-2465         | \$479 |
| RP-2405         | \$279 | PR-9606 (9 pin) | \$499 |
| RP-2406         | \$299 | PR-2465Q        | \$599 |
| RP-2420         | \$409 | PR-2466         | \$699 |

### EPSON

| CPU        | RAM (MB) | HD (MB) | Price  |
|------------|----------|---------|--------|
| 386 SX/25  | 4        | 60      | \$1375 |
| 486 SLC/33 | 4        | 120     | \$2295 |

386 w/ DOS; 486 w/ DOS & Windows and Mouse

### NEW!

|         |          |             |        |
|---------|----------|-------------|--------|
| SubNote | 486SX/25 | 9 1/2" Mono | \$2295 |
|---------|----------|-------------|--------|

PCMCIA, Trackball, Built-in Sound (MS Sound, SB/AdLib compat.), DOS 6.2, WIN 3.1, Battery. Only 4 lbs! Colour opt. **INTRODUCTORY PRICE \$2295**

### TERRANOTE

(VOLUME DISCOUNT AVAILABLE)  
w/ Trackball, Fax Modem, DOS, Windows, Built-in Sound

| Model  | CPU       | RAM | HD  | Price  |
|--------|-----------|-----|-----|--------|
| LCD64  | 486 SX/25 | 4   | 120 | \$2390 |
| LCD64  | 486 SX/25 | 4   | 200 | \$2675 |
| LCD64  | 486 DX/33 | 4   | 120 | \$2795 |
| LCD64  | 486 DX/33 | 4   | 200 | \$2995 |
| TFT256 | 486 SX/25 | 4   | 120 | \$4475 |
| TFT256 | 486 SX/25 | 4   | 200 | \$4675 |
| TFT256 | 486 DX/33 | 4   | 120 | \$5095 |
| TFT256 | 486 DX/33 | 4   | 200 | \$5275 |

### Raven Laser Printers

|        |       |          |        |
|--------|-------|----------|--------|
| LP-510 | \$779 | LP-1030  | \$1445 |
| LP-530 | \$999 | LP-570PS | \$1649 |

**Raven Slim Laser Printers**

|        |       |          |        |
|--------|-------|----------|--------|
| LP-410 | \$749 | LP-470PS | \$1299 |
|--------|-------|----------|--------|

**Raven Fax Machines**

|        |       |        |       |
|--------|-------|--------|-------|
| RF-350 | \$525 | RF-360 | \$595 |
|--------|-------|--------|-------|

OTA is an Authorized RAVEN Reseller

### 14,400 FAX MODEMS

| BRAND NAME | US Robotics Sportstar | Intel | ATI   | GVC   | Supra |
|------------|-----------------------|-------|-------|-------|-------|
| Internal   | \$219                 | \$239 | \$219 | \$219 | \$219 |
| External   | \$239                 | \$269 | \$249 | \$239 | \$239 |

Prices are subject to change at any time without notice. Call for our current prices and product availability.

Go for the best... Go for the **GOLD!**

|                                      |  |   |                                     |
|--------------------------------------|--|---|-------------------------------------|
| <br>Novell Authorized Service Centre | <b>Novell Experts!</b><br>Installation/Setup/Support/Maintenance<br>Access & Gateway Server Installation<br>2 Certified Netware Engineers on Staff | <b>AST COMPACT</b><br>Authorized Service Centre<br>Novell Labs Tested & Approved<br>File Server and Workstation | <br>Novell Gold Authorized Reseller |
|                                      | <b>IBM</b> <b>Panasonic</b><br>Authorized Service Centre   |   |                                     |
|                                      | Novell Labs Tested & Approved<br>File Server and Workstation   |   |                                     |

**AMNET 2000 INC.** 1025 McNicoll Ave., 2nd Fl., Scarb., Ont. M1W 3W6  
 Ph: (416) 499-3030 Fx: (416) 499-5128

|  |   |
|--|---|
| <b>VESA LOCAL BUS</b><br><b>486DX-33/40 \$ 1,499</b><br><b>486DX-50 \$ 1,699</b><br><b>486DX2-66 \$ 1,749</b><br>•VESA Local Bus 32 Bit Motherboard<br>•Built-In Math Co-processor<br>•4 Meg Fast RAM Memory<br>•250 Mb Hard Drive<br>•1.44 Mb or 1.2 Mb Floppy Drive<br>•VESA LB 1Mb SVGA Card<br>•Super IDE Controller, 2S/1P/1G<br>•14" SVGA (1024 x768) Monitor<br>•101 Enhanced Keyboard<br>•Minitower or Desktop Case<br>•3 Button Mouse & Pad<br>Warranty: 2 Years Labour & 1 Year Parts • All Prices are subject to change without notice. • All Prices are for Cash or Certified Cheque | <b>MULTI MEDIA</b><br>Panasonic 562 (320ms/300kb)<br>Double Speed CD-ROM Drive <b>\$ 289</b><br>Philips MDL-206 (320ms/300kb)<br>Double Speed CD ROM Drive <b>\$ 299</b><br>Sound Wonder w/Speaker <b>\$ 75</b><br>Sound Blaster 16 Basic <b>\$185</b><br><b>Multi Media VESA LB 486DX-33</b><br>Same config. as 486DX-33 plus:<br>•Philips Double Speed CD-ROM Drive<br>•Sound Card, pair of Speakers<br>•Grolier Encyclopedia 6.0 <b>\$ 1,899</b><br>100's of Unlisted CD Titles Available...Please Call!<br>Warranty: 2 Years Labour & 1 Year Parts • All Prices are subject to change without notice. • All Prices are for Cash or Certified Cheque |
|--|---|

• Best Price • Best Quality • Best Service • Guaranteed!!

**HVM COMPUTERS** Store Hours  
 101 Duncan Mill Rd., Suite G1, Don Mills, Ont. M3B 1Z3 Mon - Fri • 11:00AM - 6:00PM  
 TEL: (416) 446-0535 • FAX: (416) 446-0591 Saturday • 12:00AM - 5:00PM

up to **95% OFF**  
**THE ENTIRE STORE !!!**

**HURRY! LIMITED TIME ONLY!**  
 FIRST COME, FIRST SERVED  
 ON 1 OF A KIND ITEMS.

**THE Soft Connection**  
 WHERE COMPUTING MINDS CONNECT  
**TEL:(416)733-9001**

**Examples of the SALE**

|                            |       |
|----------------------------|-------|
| E.A. LOTUS 123             | \$38  |
| WINSPED                    | \$19  |
| AFTERDARK V2.0             | \$18  |
| DRAG CAD V2.1 WINDOWS      | \$139 |
| FRACAL DESIGN PRINTER V2.0 | \$199 |
| PERFORM PRO PLUS           | \$59  |
| DELIVERPOINT II ENHANCED   | \$25  |
| THE RANDOM ENCYCLOPEDIA    | \$15  |
| FASTBACK PLUS              | \$12  |
| ACTI V2.1                  | \$80  |
| MICROGRAPH CHARMMA V2.1    | \$32  |
| GENERIC CAD                | \$59  |

6091A YONGE ST. WILLOWDALE ON. M2M 3W2  
 11:00am to 8:00pm - Weekdays  
 12:00pm to 6:00pm - Weekends

**COMPAC RBM SYSTEMS**  
 2370 Midland Avenue, Unit A-15, Scarborough, Ontario M1S 5C6  
 Tel: (416)609-3034 Fax: (416)609-3843

|               |         |
|---------------|---------|
| 386SX40       | \$ 895  |
| 386DX40/128K  | \$ 945  |
| 486SLC33      | \$ 915  |
| 486DLC40/128K | \$ 1045 |

Include: 4MB RAM,Quantum 127MB H/D,1.44MB F/D,SVGA/512K, 14" VGA .31 Colour Monitor,101 Keyboard,IDE I/O, Mini Tower Case/5 bays,Math-Co on DLC40

**VESA LOCAL BUS SYSTEM**

|           |         |
|-----------|---------|
| 486SX33   | \$ 1289 |
| 486DX33   | \$ 1469 |
| 486DX2-50 | \$ 1519 |
| 486DX50   | \$ 1679 |
| 486DX2-66 | \$ 1729 |

Include: 128k Cache,Math-Co,4MB RAM,1.44MB F/D, Quantum 270MB H/D,SVGA/1MB (VESA), 14" SVGA .39 Colour Monitor,IDE I/O, Mouse, 101 Keyboard,Mini Tower/6 bays

|                         |        |
|-------------------------|--------|
| Mother Board            |        |
| 386SX40/CPU             | \$ 95  |
| 386DX40/128k/CPU        | \$ 159 |
| 486SLC33/CPU            | \$ 129 |
| 486DLC40/128k/CPU       | \$ 259 |
| 486SX33/128k/CPU/VESA   | \$ 289 |
| 486DX33/128k/CPU/VESA   | \$ 479 |
| 486DX2-50/128k/CPU/VESA | \$ 529 |
| 486DX50/128k/CPU/VESA   | \$ 689 |
| 486DX2-66/128k/CPU/VESA | \$ 739 |

|                  |        |
|------------------|--------|
| Hard Drive (IDE) |        |
| W.D. 212MB       | \$ 275 |
| W.D. 256MB       | \$ 295 |
| W.D. 340MB       | \$ 375 |
| W.D. 426MB       | \$ 475 |

|                      |        |
|----------------------|--------|
| Monitor              |        |
| 14" GOLDSTAR VGA .31 | \$ 189 |
| 14" RBM SVGA .39     | \$ 259 |
| 14" RBM SVGA .28     | \$ 299 |
| 14" RBM SVGA .28 N/I | \$ 349 |
| 17" RBM SVGA .26 N/I | \$ 889 |

|                        |        |
|------------------------|--------|
| Printer                |        |
| Raven 2406(colour opt) | \$ 285 |
| Brother HL400 Ink Jet  | \$ 375 |
| Brother HL6 Laser 6PPM | \$ 695 |

|                          |                         |
|--------------------------|-------------------------|
| Panasonic CD ROM CR562   | \$ 285                  |
| 320ms + 64k Buffer +     |                         |
| Sound Card + 5 CD Titles | (with purchase of 2 CD) |
|                          | (at regular price)      |
|                          | <b>\$ 459</b>           |
| Goldstar CD ROM R400B    | \$ 189                  |
|                          | (with purchase of 2 CD) |
|                          | (at regular price)      |
|                          | <b>\$ 189</b>           |

|                          |        |
|--------------------------|--------|
| Home 14/14 Ext Fax Modem | \$ 185 |
| 1 Meg Simm Ram           | \$ 52  |

All Prices are subject to change without notice

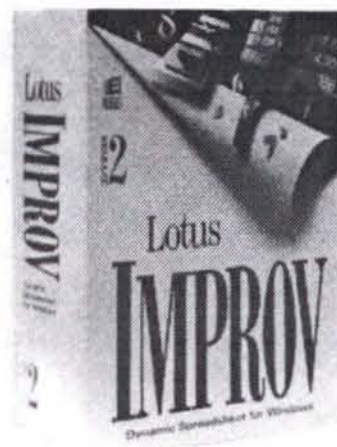

Lotus Improv and CA-Compete add powerful functions to traditional spreadsheets.

from a column to a row, or combining categories to see the totals. By storing data centrally in a database, providing for global formulas, and using meaningful names to describe information, the door is open to complex multidimensional analysis.

Traditional spreadsheets can track data in two or three dimensions. For example, a budget worksheet will have months across the top and budget line items down the first column; that's a two dimensional spreadsheet. Duplicate this sheet for your various departments and you have three dimensions.

This works fine until you want to add actual numbers to your spreadsheet. Yes, you can create separate 3-D sheets and use links to create a picture that shows you your budget versus the actual numbers. But it's not easy to do and it is prone to errors. What you really want is a fourth dimension to handle the additional data. With multidimensional modelling software, you link the new numbers and they appear on a new sheet.

The key to this wizardry is the database structure of the programs, which does not tie a particular data point to a specific cell. Both Improv and CA-Compete allow you to create global formulas. Instead of copying a formula like you do in a traditional spreadsheet, you merely reference the global formula. You can also work with real names instead of obscure cell references. For example, a formula could read Net Profit = Sales - Expenses. It's that easy.

Does this mean that you have to learn an entirely new skill set in order to work with multidimensional modelling? No, both CA-Compete and Improv still look like spreadsheets. CA-Compete even has a 2-dimensional spreadsheet mode that looks and works like Microsoft Excel.

A comparison of the features of the two products indicates different strengths and weaknesses. The grouping function in Improv is significantly stronger than that in CA-Compete. With Improv it's easy to group all budget items tied to sales. You merely select the items, choose the Create Item Group command and name the group. In CA-Compete you must manually create the formulas.

Improv is also stronger in its viewing and reporting functions. You can change the view by simply dragging the category icons around and you can stack the icons on top of each other. This allows you to display data from more than two dimensions at once. CA-Compete only allows you to display two dimensions.

When it comes to data analysis, however, CA-Compete is superior. It has several powerful analysis options that aren't available in Improv. You can eliminate missing data with the allocation tool, and there is a unique

goal setting command that helps with problem solving.

Both CA-Compete and Improv break new ground in the numbers world. Unfortunately there is a price to pay for this functionality. Both programs are far more complicated than the traditional spreadsheet. The art of thinking in four or more dimensions requires a grasp of some major new concepts and there is no doubt that the learning curve for these products is steep. Fortunately, both programs have useful tools to assist you.

The bottom line is that users whose spreadsheet needs are limited to simple budgets should stick to the mainstream spreadsheet programs. But if you require highly sophisticated data models, then a multidimensional spreadsheet is the way to go.

**The Mainstream Gets Deeper**

For readers who are using one of the three mainstream spreadsheet products, your favorite spreadsheet just got better. By the time you read this new version of Microsoft Excel, Quattro Pro and Lotus 1-2-3 for Windows will have been released.

Here's a quick picture of what to expect in the latest versions of Excel and 1-2-3. A separate review for Quattro Pro for Windows Version 5.0 appears elsewhere in this issue.

Lotus 1-2-3 for Windows Version 4.0 was released last fall and finally provided Lotus users with a solid Windows spreadsheet. The product has been totally reworked and incorporates both the standard features we now expect in a windows spreadsheet, as well as some bold innovative features.

Topping the list of new features is the version manager which allows users to create named sets of alternative values (scenarios). Once the version has been saved you can go back to it at any time to see the scenarios. For example, you could create versions for each week of sales and call up your sales figure for that week on demand.

The spreadsheet interface has also been completely updated. Release 4 now offers named pages, much like those in Quattro Pro for Windows. Page tabs appear along the top of the window and names assigned to pages are automatically used in formulas.

All data entry and editing now takes place in the cell. New features include an edit bar, a navigator icon and a function icon to assist with formula building. The function library has been greatly expanded with over 100 new functions available.

The status bar includes buttons for changing the fonts and other formatting, and for turning off features such as Smart-Icons. The right mouse button now calls up context-sensitive menus whenever you click on a cell. In-cell editing makes changes far easier since you do not have to move your

Continued on page 45

**SPREADSHEETS**

# Lotus Adds Multimedia Features To 1-2-3

BY GRANT BUCKLER

CAMBRIDGE, MA (NB) — Lotus Development has introduced a multimedia edition of its 1-2-3 for Windows spreadsheet software, and a utility that can make "movies," with sound, of operations performed on the PC.

1-2-3 Release 4 for Windows: Multimedia Edition has several features that support its claim to multimedia capability. The first is Multimedia SmartHelp, a set of learning tools that Lotus has offered for some time. These tools include an animated and narrated guided tour of the software, animated clips that describe the way the program works, an audible proofreader, and on-line documentation.

The package also comes with Lotus Sound, Lotus Media Manager, and Lotus Annotator. Lotus Sound lets users create, edit, save, and play sound as .WAV files. Lotus Media Manager is used to preview multimedia files, and Lotus Annotator makes it possible to create and embed multimedia notes in Windows applications.

The final multimedia feature in 1-2-3 Release 4 for Windows: Multimedia Edition is ScreenCam, software which can record operations a user performs on the computer, (much as a macro recorder records actions), add audio such as a running commentary on what the user is doing, and then play the "movie" back.

ScreenCam will initially be sold as part of the multimedia edition of 1-2-3 for Windows, but will later be offered as a stand-alone project and bundled with other Lotus applications, the company announced.

A spokeswoman for the company said the stand-alone version of ScreenCam can be expected in the first quarter of 1994, and other Lotus applications will be released with ScreenCam during the coming year.

In the meantime, customers who buy 1-2-3 for Windows: Multimedia Edition with ScreenCam can use the utility with other Windows applications as well as with the spreadsheet. They can also create ScreenCam movies that involve more than one application, the spokeswoman said.

ScreenCam requires a PC with at least a 386 processor and about one megabyte (MB) of memory beyond what the application with which ScreenCam is to be used requires. To use the audio capabilities, the PC must also have a sound card or portable sound device, microphone, and speakers. ScreenCam can be used without audio if the PC is not equipped for it, the spokeswoman said.

ScreenCam movies take less than one megabyte of disk space per minute, the spokeswoman told Newsbytes.

1-2-3 Release 4 for Windows: Multimedia Edition needs at least a 386 processor, four MB of memory with a two MB swap file, Windows 3.1, a VGA 16-color graphics adapter and monitor, and a compact disk read-only memory (CD-ROM) drive with a transfer rate of at least 150K per second, the company said. Some features call for a sound card, speakers, or headphones, and a mouse is recommended but not required.

The suggested retail price of the multimedia 1-2-3 for Windows is \$495, Lotus said, and upgrades from all other releases and from competitive spreadsheets will cost

\$129.

Lotus has no public plans for a multimedia edition of 1-2-3 on the Apple Macintosh or any other hardware, a company spokes-

woman said, but a further announcement is likely later this year. ■

Contact: Lotus Canada, 416-979-8000

## Let Us Be Your Network Solution!!!

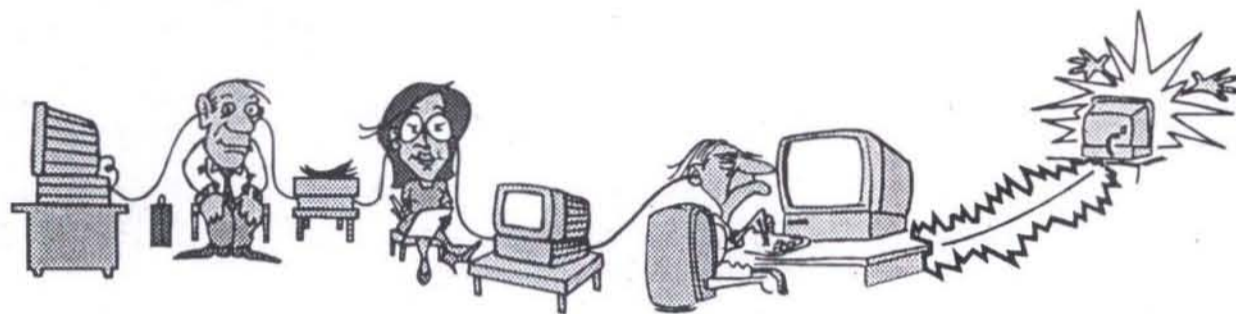

### NOVELL TURN KEY SYSTEM!!!

**Complete Package Ready to Go! ➡ \$5900**

Package Includes: Server, 4 Workstations, Novell 3.12 (5 user), and cables  
**486DX/33 Server comes with 4MB RAM, 210MB Hard Drive, 1.44 MB Floppy Drive, Ethernet NIC, IDE Controller & I/O, 14" monitor, 101 Enhanced Keyboard, Mini Tower Case**

**386DX - 40MHz Workstations Include:** 1MB RAM, 1.44 MB Floppy Drive, IDE Controller & I/O, Ethernet NIC, 14" Monitor, 101 Enhanced Keyboard, Mini Tower Case

### Certified Network Engineers Here to Help You!

**Multi-media System  
386DX-40MHz**

- 4MB RAM, 128K Cache
  - 245MB Hard Drive
  - 1.44 MB Floppy Drive
  - IDE Controller & I/O
  - Trident 512K SVGA Card
  - 14" SVGA Color Monitor
  - 101 Enhance Keyboard
  - 3-Button Mouse
  - Mini Tower Case
  - Sound Blaster Compatible Card
  - CD Rom Drive
  - Speakers
- \$1488**

**Multi-media System  
486SX-33MHz**

- 4MB RAM, 128K Cache
  - Pentium Upgradable
  - 245MB Hard Drive
  - 1.2 & 1.44 MB Floppy Drive
  - IDE Controller & I/O
  - Trident 512K SVGA Card
  - 14" SVGA Color Monitor
  - 101 Enhance Keyboard
  - 3-Button Mouse
  - Mini Tower Case
  - Sound Blaster Compatible Card
  - CD Rom Drive
  - Speakers
- \$1628**

**Multi-media System  
486DX-33MHz**

- 4MB RAM, 128K Cache
  - Pentium Upgradable
  - 245MB Hard Drive
  - 1.2 & 1.44 MB Floppy Drive
  - IDE Controller & I/O
  - Trident 512K SVGA Card
  - 14" SVGA Color Monitor
  - 101 Enhance Keyboard
  - 3-Button Mouse
  - Mini Tower Case
  - Sound Blaster Compatible Card
  - CD Rom Drive
  - Speakers
- \$1828**

**DIAMOND PRO 14**

14" CRT  
0.28mm Dot Pitch  
1024 x 768 Max  
H31.0-38.5Hz Auto Scan  
V40 - 90Hz  
Up-Rent Control  
Meets MRP-2 Standard

**\$79\***

**DIAMOND SCAN 15FS**

15" Flat Square CRT  
0.28mm Dot Pitch  
Incr Shadow Mask  
1024 x 768 Hz (76Hz)  
H31.0-40Hz Auto Scan  
V50 - 90Hz  
Up-Rent MRP Control  
Meets MRP-2 Standard

**\$295\***

**DIAMOND SCAN 17FS**

17" Flat Square CRT  
0.28mm Dot Pitch  
Incr Shadow Mask  
1024 x 1024 Hz (76Hz)  
H30.780Hz Auto Scan  
V60 - 100Hz  
Meets MRP-2 Standard  
Energy Star Power Management  
Dynamic Beam Focusing

**\$995\***

Free CORE DRAW!

**MITSUBISHI**

ELECTRIC SALES CANADA INC.

**LOW RADIATION  
\* MONITOR  
UPGRADE**

**ZEGNA ELECTRONIC INC.**

**TORONTO** TEL: (905)479-8892  
FAX: (905)479-1045  
160 KONRAD CRES., MARKHAM, ONT.

**MISSISSAUGA** TEL: (905)848-9822  
FAX: (905)848-9824  
1310 DUNDAS ST. E., #17, MISSISSAUGA, ONT.

TORONTO MISSISSAUGA VANCOUVER

# Footprint Works for OS/2

Five Integrated OS/2 Applications at a Bargain Price

BY JOHN F. BOYCE

**Product:** Footprint Works for OS/2  
**Vendor:** Footprint Software Inc., 53 Yonge St., Toronto M5E 1J3  
**Price:** \$129 (introductory price)

Though more and more PC users, frustrated with the limitations of the DOS/Windows environment, are switching to OS/2, the increasing market for native OS/2 applications has, to a large extent, been ignored by many of the big development houses. This demand has not gone unnoticed by many smaller software companies, who are turning out well-designed, quality applications, engineered to exploit the richness of the 32-bit OS/2 environment.

One such company, Footprint Software Inc. of Toronto, has recently released an integrated suite of applications which bundles a full-featured word processor and spreadsheet with charting, database, and report writing modules.

Right from the initial installation it is clear that the designers set out to develop an application which takes full advantage of OS/2's capabilities: The install program is multithreaded, permitting me to fax a letter in the background and read an extensive help section on configuring the application it while the diskettes were copied and expanded unobtrusively in the background. I was impressed with the slick and polished

user interface which makes effective use of animation to remind you, for example, that the next disk should be inserted into the floppy drive.

This installation program and its uninstall capability should cause other application developers to sit up and take notice of how the job should be done.

From my perspective the real gem in this suite of applications is the word processing module. It offers about 80 percent of the functionality of mainstream word processing applications like Describe and Ami Pro for OS/2 (which I reviewed in the January issue of *The Computer Paper*), without the performance penalty. With the possible exception of equation editing, footnotes and outlining, there are few challenges that Footprint Works cannot meet.

A spelling checker (U.S. dictionary, unfortunately) is, of course, included along with a thesaurus, and table editing is simple and easy to use. A very capable mail-merge function is integrated nicely with the data filer application. A macro language permits

many tasks to be easily automated.

Footprint Works includes a full import and export capability for a comprehensive collection of word processing applications and graphic formats. All of this capability comes — surprisingly — without compromising performance; scrolling is fast and responsive.

Matching the quality of the word processor is a spreadsheet application which I found easy to use and full-featured. While this is not a spreadsheet for professional analysts, there are a large number of statistical, financial and trigonometric functions provided, which should serve most casual users more than adequately.

The plotting capability within the spreadsheet itself is disappointing — you can have any chart you want, as long as it's a bar graph. This is not a serious limitation though, as the data links to a more fully featured charting module are easy to make.

Another module that, by itself, justifies the cost of the package is the database application, which permits the user to create and enter data in complex multipage forms. Data

records can be textual, numerical or graphical, with a broad range of image formats supported, including GIF, TIF, EPS, DXF, and PCX.

The few formats I tried were imported reliably without problems. A feature shared with the word processing application is a simple draw program which can be used to add shapes and figures to records for emphasis and illustration. The database integrates nicely with the other applications in the suite to increase their utility. For example, it works with mail merge in the word processor, and the report writer to organize and present data in a columnar format.

Footprint Works takes full advantage of the 32-bit OS/2 environment. Multithreading is used extensively for background printing, data retrieval, document formatting and recalculating spreadsheets. This has the pleasing effect of making the over-all performance snappy and more than acceptable on computers equipped with 8 MB of RAM.

At an introductory price of C\$129, the word processor or database would be a deal individually. Together, bundled with a spreadsheet, charting program and report writer, this is great value. "Icing on the cake" is provided through toll-free 800 support and the fact that it is from a Canadian developer. If you're into OS/2, give this application a hard look!

Footprint Works is available through Below Zero in Calgary (800-461-2777), or directly through the developer, Footprint Software, Toronto (800-465-8470). ■

John F. Boyce is a Vancouver-based independent consultant specializing in OS/2 systems and networks.





**RAINBOW COMPUTER SYSTEMS**

## RAINBOW COMPUTER SOFTWARE SALE

## 中英文軟件出售

## HARDWARE SALE

- Business
- Accounting
- Education
- Games
- Applications

2466 Eglinton Ave. E., Unit 5  
 Scarborough, Ontario M1K 5J8  
 Tel: (416) 266-6133  
 Fax: (416) 266-2744



### TRUE 486 VESA Bus Systems

2 Yr Parts & Labor Warranty  
Whole System CSA approved

|                         |   |                                       |       |
|-------------------------|---|---------------------------------------|-------|
| <b>SX-25MHz \$1219</b>  |  | <b>Upgrade your existing system ?</b> |       |
| <b>DX-33MHz \$1449</b>  |   | M/B 486DX-33/128K                     | \$450 |
| <b>DX2-66MHz \$1749</b> |   | M/B 486DX2-66/128K w/Fan              | \$730 |
|                         |   | Memory SIMM 1MB                       | \$53  |
|                         | VESA IDE I/O 2S/P/G   | \$35                                  |       |
|                         | VESA SVGA 1MB exp. 2MB  | \$130                                 |       |
|                         | Corel Draw 3.0 full package   | \$120                                 |       |
|                         | Mitsumi CD Drive 280ms  | \$205                                 |       |
|                         | Conner 250MB Tape backup  | \$205                                 |       |
|                         | Orchestra 14" NI SVGA .28dp   | \$315                                 |       |
|                         | Orchestra 15" NI SVGA .28dp   | \$499                                 |       |
|                         | Orchestra 17" NI SVGA .26dp   | \$980                                 |       |

Cache RAM 128k exp.256k  
 Memory 4MB exp.128MB  
 FD 1.44MB, HD 120 MB  
 2 Button Mouse

IDE I/O 2S/P/G ports  
 Mini Tower w/digital display  
 101 Enhanced Keyboard  
 Orchestra 14" SVGA .28dp

**VESA SVGA Card 32 bit 1MB exp.2MB**

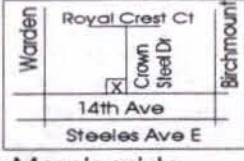

**COMPASS TECHNOLOGIES**  
 18 CROWN STEEL DR. STE 103-4 MARKHAM  
 Tel: (905)415-8855 Fax: (905) 415-8854

\*FREE delivery within 16th Ave, Eglinton, Bathurst & Morningside.  
 Open Sunday 10am - 2 pm All prices are CASH DISCOUNTED and subject to change without notice.

## Software GALORE

"THE FRIENDLY STORE"

We carry over 50 brands of PC & Mac software, diskdrives, soundcards & other accessories  
 Hundreds of books, all 20% off.

NEW

Many new CDs now in stock. King's Quest VI is available on CD and for owners of previous versions, we have in stock, an upgrade for only \$39.95. The CD Version is greatly enhanced with 50Mb of animated introduction and the clips in the game have lip sync sound!

**Did You Know?**  
 OS/2 is a next generation operating system. It is designed to take advantage of 386 class PCs or higher as opposed to DOS which was designed 15 years ago for 8086 class PCs. The differences are dramatic and unappreciated by most PC users. Even dedicated DOS users (not Windows) can benefit greatly by installing a stripped down version of OS/2 and be able to take advantage of multiple concurrent DOS sessions, each with their own config. sys, etc. In this stripped down configuration, it will run very well on 4Mb ram. A full installation including multimedia extensions requires 8Mb and recommended 16Mb ram.

**A small sample of our everyday prices...**

|                                    |           |
|------------------------------------|-----------|
| Describe 4.0 OS/2 Trade-Up         | \$155.95  |
| WordPerfect 5.2 OS/2 Trade-Up      | \$159.95  |
| Lotus 123 2.0 OS/2 Trade-Up        | \$138.00  |
| Lotus Freelance 2.0 OS.2 Trade     | \$136.95  |
| Resish OS/2 contact manager        | \$224.95  |
| Designer for OS/2                  | \$569.95  |
| OS/2 2.1 Upgrade                   | \$139.95  |
| ASI 9000 486DX33 4Mram 212MbHD     | \$1750.00 |
| ASI 9000 17" digital monitor .28mm | \$999.00  |



Oakville

**Microsoft** **Lotus**

**BORLAND**

**WordPerfect** **IBM** **COMPUTER ASSOCIATES**

Ph. 905-847-7331  
 Fax 905-847-3438

9 to 9 Mon. to Friday  
 10 to 6 Saturday

# BUY YOUR COMPUTER FROM A MANUFACTURER AT A WHOLESALE PRICE

## MDG COMPUTERS CANADA INC. 255-9343

Prime Quality Motherboard, 130MB Hard Drive, 1.44MB Fujitsu Floppy Drive, Elegant Case with 200w P/S, 2 Serial/1 Parallel/1 Game, 101 Enhanced Keyboard, Mouse, SVGA Trident Card, 14" Ergonomic Magnavox SVGA 1024x768 Monitor, 4MB RAM.

**We will better your best quote on a system by \$30.00 or it's free!\***

486DX/33

**\$1349**

486DLC/33

**\$1069**

486DX/50

**\$1615**

486DX/66

**\$1715**

VESA Local Bus Systems, 256 KB Cache, 4MB RAM (0ws), 245MB Maxtor Hard Drive, 1.2 and 1.44 MB Fujitsu F.D., VESA Local Bus SVGA Card, 32 bit VESA IDE Controller, 2S/1P/1G Ports, 101 Enhanced Keytronic Keyboard, Deluxe Case with 230w P/S, **15 Inch Flat Screen SVGA Low Radiation Monitor.**

**2 Years Parts, Five Years Labour Warranty**



486DX/33

**\$1955**

486DX/50

**\$2155**

486DX/66

**\$2275**

Pentium upgrade  
+  
Ziff Sockets  
Best Quality Motherboards  
in North America

**WHY SPEND HUNDREDS OF \$\$\$\$ MORE? BUY DIRECTLY FROM MDG**

*Government and Corporate Purchase Orders Welcome*

**UPGRADE SPECIALS: UPGRADES DONE WHILE YOU WAIT**

### MOTHERBOARDS:

486DX/256KB/ZIF.....\$245  
486DLC/33.....\$165  
486DX/33.....\$439  
486DX/50.....\$645  
486DX/66.....\$695

### HARD DRIVES:

120MB SAMSUNG.....\$220  
130MB MAXTOR.....\$230  
245MB MAXTOR.....\$299  
340MB MAXTOR.....\$420  
445MB SEAGATE.....\$575

### OTHER:

VESA CON IDE + VGA.....\$175  
14.4 FAXMODEM.....\$175  
14.4 FAXMODEM USR.....\$225  
SONY MULTI-MEDIA KIT.....\$395  
DOS 6.0 or WINDOWS 3.1.....\$55

CALL FOR PRICING ON SCSI DRIVES, OR ANY OTHER DRIVE

We will match any advertised price for other items

*Absolutely The Best Prices in Canada*

Network Installations,  
Service Contracts  
Available

**MDG 255-9343**

**New Hours:**

Mon - Fri 9-8  
Saturday 10-6  
Sunday 12-5

**MDG 255-9343**

415 HORNER AVE #2  
(QEW & HWY 427)  
ETOBICOKE, M8W 4W3  
FAX # 255-8672

*Up to \$100 manufacturer's cash rebate for government and corporate orders.*

All prices are cash discounted and subject to change without notice. VISA +3%, a member of Better Business Bureau.  
\* Upon verification of product availability and quote.

CALL FOR CURRENT MEMORY PRICING

**GET THE BEST PRICE FOR YOUR COMPUTER THEN GIVE US A CALL**

# CHECK US OUT...

## COMPLETE SYSTEMS

|              |         |         |
|--------------|---------|---------|
| 486SLC 33Mhz | 1Mb RAM | 699.00  |
| 486DLC 33Mhz | 2Mb RAM | 939.00  |
| 486DLC 40Mhz | 2Mb RAM | 979.00  |
| 486SX 33Mhz  | 4Mb RAM | 1145.00 |
| 486DX 33Mhz  | 4Mb RAM | 1375.00 |



**MOST COMPONENTS AT RIDICULOUS PRICES!**

### MOTHERBOARD

|              |        |
|--------------|--------|
| 386SX 40Mhz  | 95.00  |
| 486SLC 33Mhz | 125.00 |
| 486DLC 25Mhz | 147.00 |
| 486DLC 40Mhz | 179.00 |
| 486DX 33Mhz  | 457.00 |

### MONITORS

|                |        |
|----------------|--------|
| SVGA 0.39      | 259.00 |
| SVGA 0.28      | 285.00 |
| SVGA 0.28 NI   | 315.00 |
| 15" Flatscreen | 475.00 |

|                         |        |
|-------------------------|--------|
| ZOLTRIX FAX/MODEM 96/24 | 49.00  |
| ZOLTRIX FAX/MODEM 14,4k | 179.00 |

Prices subject to change without previous notice

**Canadian Business Automation Inc.**  
5172 Dundas Street West. at Kipling Tel:237-0363

## NEW YEAR SPECIALS NOW ON !!

| NOTEBOOKS & LAPTOPS   |              |
|---|--------------|
| Leading Edge 386SX Laptop, 2/40MB VGA Backlit               | FROM \$699   |
| Zenith 386SX Laptop VGA                                     | FROM \$1,099 |
| NEC 386SX Laptop, 2/40MB                                    | FROM \$1,099 |
| Zenith 386SX Laptop, 4/60, VGA Backlit                      | FROM \$1,199 |
| Dell 386SX NB, 4/60, Fax/Modem, Windows, Mouse              | FROM \$1,499 |
| Leading Edge Colour Notebook, 2/60 MB                       | FROM \$1,499 |
| INEX 486 SLC, 4/80 MB, Notebook                             | FROM \$1,799 |
| Compaq 486 DX/25, 4/80 MB, Fax/Modem, Trackball             | FROM \$1,799 |
| Toshiba 486 SX/25, 4/80 MB, Gas Plasma                      | FROM \$1,899 |
| Texas Instruments 486 SX/25, 4/120 MB                       | FROM \$1,999 |
| Toshiba T1850C, 4/120 MB Colour Notebook                    | FROM \$2,299 |
| Toshiba T4600 486/33, 4/120 MB, Notebook                    | FROM \$2,350 |
| IBM Letter Quality Printer FROM \$49                        |              |
| IBM Laser Printer FROM \$199                                |              |
| Kodak Diconix Notebook Ink Jet Printer FROM \$199           |              |
| Dell 486 DX/25, 4/200 MB FROM \$2,599                       |              |
| Toshiba T1900C 486, 4/120 MB Colour Notebook FROM \$2,699   |              |
| Toshiba T1950 486 DX/240, 4/200 MB FROM \$2,799             |              |
| Zenith Z-Note 429LN, 4/200 MB Active Colour NB FROM \$3,199 |              |
| DESKTOPS  |              |
| IBM PS/2 Model 50Z  | AS IS \$149  |
| Dell 486 SX/33, 4/170 MB, SVGA **                           | FROM \$899   |
| Dell 486 DX/33, 4/120 MB, SVGA **                           | FROM \$999   |
| Dell 486 DX/250, 4/170 MB, SVGA **                          | FROM \$1,199 |
| Dell 486 DX/250, 4/200 MB, SVGA **                          | FROM \$1,399 |
| Dell 486 DX/250, 4/500 MB, SVGA **                          | FROM \$2,499 |
| Kodak Diconix Notebook Ink Jet Printer                      | FROM \$199   |
| IBM Letter Quality Printer                                  | FROM \$49    |

COMPUTER LIQUIDATION CENTRE (905) 602-6077  
2601 MATHESON BLVD., EAST, UNIT 6, MISSISSAUGA, ONT.

## SPREADSHEETS

# Quattro Pro 5.0

## For Windows

*A Significant Step  
In Spreadsheet Evolution*

BY KEITH  
SCHENGILI-ROBERTS

**Title:** Quattro Pro 5.0 for Windows  
(Workgroup Edition reviewed)  
**Manufacturer:** Borland  
**Basic System Requirements:** a basic Windows-compatible machine (e.g., 386SX PC running Windows 3.1, with a minimum of 10MB free hard disk space and 4MB of RAM)  
**Price:** Stand-alone Version \$129.95  
Workgroup Edition \$646

Spreadsheets have come a long way since VisiCalc, the original spreadsheet program, was launched in the late 1970s. VisiCalc removed some of the drudgery from financial calculations, but it didn't have many frills.

What separates today's spreadsheets from those of yesteryear is versatility and performance. It's hard to find a spreadsheet program today which does not include every sort of feature imaginable, and which will not jump through hoops if you ask it.

Borland's new Quattro Pro 5.0 for Windows is a significant step in the on-going evolution of spreadsheet software. It is loaded with a lot of useful features. Most people will never use these features, but you'll be grateful to have them when you do need them.

Quattro Pro 5.0 for Windows continues a concept first implemented in version 1.0 of a notebook: "finger-tab" markers that separate the different spreadsheets on-screen. Just click on the alphabetically-ordered tabs, and you can easily flip between spreadsheets.

This is probably the most intuitive arrangement for producing "3-D" spreadsheets, where data and functions from one spreadsheet are linked to another at another "layer." The number of different spreadsheets you can have on-screen at once is limited only by the amount of memory you have on your computer.

This is a very "friendly" program, and is in many ways ideal for the beginning spreadsheet user. A manual is included with the program, and complete documentation for the program is available directly through the program's extensive help system. Picking up on the trend started by WordPerfect 5.0 for DOS, the program has an Interactive Tutor which guides the new user through many

tasks, and is designed to allow the user to learn how a function applies while actually working on a document. This "on the job" approach to learning has far more use and impact on the user than other Help formats.

A space at the bottom of the window is reserved for a summary explanation of the icon your mouse pointer happens to be on. If you need more detail, hit the Ctrl key along with the right mouse button and a quick outline of how the icon functions is provided.

The SpeedFill function automatically fills in subject headings for columns or rows. For example, just enter "January" in the first column, drag out the number of cells you need with your mouse, hit the SpeedFill icon and, voila, all the months of the year will appear. This function works for many of the heading most commonly used in spreadsheets, and can be further customized by editing the program's configuration file.

The program is loaded with functions and resources that will appeal to more intermediate and advanced users. It comes with 360 @ functions, from basics like summing and averaging, to advanced scientific, engineering and financial analysis functions. While this number of @ functions will be more than enough for most people, it is disappointing that Borland has not included any support for user-defined functions.

Quattro Pro 5.0 for Windows includes a set of 19 analysis tools in addition to the @ functions. The tools help users determine such things as correlations or covariances in a given set of data, produce fourier analyses, and determine how to refinance a mortgage.

Its Scenario Manager also fits into the category of analysis tools, helping the user to produce best- and worst-case scenarios from a set of data. It highlights the changes that have been produced, giving the user a better handle on the "how" and the "why" of real-world situations. This is a particularly powerful utility in the Workgroup version of the program, which allows users to share data and analyses.

The program contains extensive graphing options. You can choose from any one of a large number of 2-D or 3-D charts and graphs on which to plot your data. You can choose sections of your spreadsheet to graph by highlighting the sections you want. One



**Borland Quattro Pro**  
Windows spreadsheet power made easy...

|  |   |   |
|--|---|---|
| <b>386 DX-40 ..... \$1,219</b><br>• 128K Cache<br>• 4MB RAM<br>• 210 MB Hard Disk Drive<br>• SVGA Card w/512K<br>• SVGA Colour Monitor (28DP)  | <b>486 VESA Local Bus</b><br>486 SX-25 ..... \$1,439<br>486 SX-33 ..... \$1,489<br>486 DX-33 ..... \$1,669<br>486 DX-40 ..... \$1,659<br>486 DX2-50 ..... \$1,729<br>486 DX-50 ..... \$1,879<br>486 DX2-66 ..... \$1,929<br>• 256K Cache<br>• 4MB RAM • 250MB Hard Disk Drive<br>• VL Bus SVGA Card w/ 1MB<br>• VL Bus IDE I/O Card<br>• SVGA Colour Monitor (28DP) | <b>Pentium 66 MHz</b><br><b>\$4,099</b><br>• 256K Cache (Up to 512K)<br>• 8MB RAM (Up to 128MB)<br>• 340MB Hard Disk Drive<br>• VL Bus SVGA Card w/2 MB<br>• VL Bus IDE Controller w/ 1 MB (Up to 4MB)<br>• Non-interlaced SVGA Monitor |
| <b>486 ISA System</b><br>486 SX-25 ..... \$1,349<br>486 DX-33 ..... \$1,579<br>486 DX-50 ..... \$1,789<br>• Intel CPU • 256K Cache<br>• 4MB RAM<br>• 210MB Hard Disk Drive<br>• SVGA Card w/1 MB<br>• SVGA Colour Monitor (28DP) | <b>486 EISA/VESA Bus</b><br>486 DX-33 ..... \$2,399<br>486 DX2-66 ..... \$2,659<br>• Intel CPU • 256K Cache<br>• 4 MB RAM<br>• 245 MB SCSI Hard Disk Drive<br>• VL Bus SVGA Card w/1MB<br>• EISA Bus SCSI-2 Controller<br>• Non-interlaced SVGA Monitor   |   |

All Systems Include: 1.2MB and 1.44MB Floppy Drives; 2 Serial, 1 Parallel, 1 Game Ports; 101 Enhanced Keyboard; Mouse; MS-DOS 6.2; Choice of Mini-tower or Desktop Case

|  |   |
|--|---|
| <b>Tape Back-up</b><br>Colorado Jumbo 250 ..... 229<br>Colorado Tracker 250 ..... 445  | <b>IDE Hard Drives</b><br>210 MB ..... 275<br>250 MB ..... 305<br>340 MB ..... 370<br>420 MB ..... 455  |
| <b>Video Capture Board</b><br>Video Blaster ..... 435<br>Pro Movie Studio ..... 395  | <b>Fax/Modem</b><br>14.4K/14.4K Internal ..... 175<br>14.4K/14.4K External ..... 225  |
| <b>Multimedia Kit</b><br>SB Discovery CD 16 ..... 569<br>SB Edutainment CD 16 ..... 659  | <b>Sound Cards</b><br>Sound Blaster 16 Basic ..... 169<br>Sound Blaster 16 Multi-CD ..... 219<br>Sound Blaster 16 SCSI-2 ..... 245<br>Pro Audio 16 Basic ..... 149<br>Pro Audio Studio 16 ..... 279 |
| <b>CD-ROM Drives</b><br>Toshiba 3401(200ms) ..... 479<br>Panasonic 562 Dual Speed ..... 269<br>Mitsumi FX001D Dual Speed ..... 269 |   |

Note: Prices subject to varying Market Conditions. All prices are cash discounted.

## KEHTRON COMPUTER INC.

461 Alden Road, Unit 22  
Markham, Ontario L3R 3L4  
Tel: (905) 513-8359 Fax: (905) 513-0973

Cherry Hill, NJ  
King of Prussia, PA  
Wilmington, DE  
Norwalk, CT

SOUND BLASTER 16.....\$199.  
ProAudio SPECTRUM 16...\$229.  
S BLASTER 16 SCSI-2 ASP...\$309.  
BIGMOUTH...\$199.



## THE PRO'S CHOICE

since 1979

Windows for  
WorkGroups  
Per User...\$249.

### COMPUTER PACKAGE DEALS!

- 386/DX/40.....\$589\*
- 486/DLC/33.....\$639\*
- 486/DX/40.....\$949\*
- 486/DX/33.....\$979\*
- 486/DX/50.....\$1199\*
- 486/DX2/66...\$1299\*
- 486/DX/33ve..\$1379\*

**ALL SYSTEMS HAVE:**

- 4 MB RAM Memory 60ns
- One 1.44 MB 3.5" Drive
- 101 Enhanced Keyboard
- Parallel, 2 Serial, Game
- 200 Watt Power Supply
- IDE HD/FDD Controller
- NO HARD DRIVE
- NO MONITOR, NO VIDEO
- Assembled & Tested-48Hr
- Mini Tower Case w LED's
- One Year Warranty, CSA

P5 Socket + 3 VESA LOCAL BUS Slots Option..\$39.  
ATI Local Bus Video..\$419. (\*128K/256K Cache Models)

• EISA MB Option.....\$199  
• ON SITE Option...\$89

## CORELDRAW! 4 \$249.

**DISKETTE DRIVES Canon~Mitsubishi~Panasonic**

3.5" 1.44 MB DS HD.....\$59. | 3.5" 2.88 MB Disk Drive/Kit..\$179.  
3.5/5.25" (360/720/1.2/1.44)...\$169. | 5.25" 1.2 MB DS HD.....\$69.

### EPSON 386SL25 NOTEBOOK 4MB 60MB HD - \$1349.

#### HARD DISK DRIVES & SCSI CONTROLLERS

|  |  |
|--|--|
| SEAGATE 130MB 15ms 32K IDE.....\$249.        | FUJITSU 105MB 14ms 24K SCSI.....\$249.       |
| MAXTOR 245MB 15ms 64K IDE.....\$309.         | MAXTOR 245MB 15ms 64K SCSI.....\$349.        |
| MAXTOR 345MB 15ms 64K IDE.....\$399.         | SEAGATE 343MB 12ms 256K SCSI.....\$523.      |
| WD 426MB 12ms 128K IDE.....\$506.            | SEAGATE 452MB 12ms 256K SCSI.....\$685.      |
| SEAGATE 452MB 12ms 256K IDE.....\$579.       | FUJITSU 520MB 10ms 256K SCSI.....\$689.      |
| WD 540MB 12ms 128K IDE.....\$753.            | TOSHIBA 1.2GB 10ms 256K SCSI.....\$1099.     |
| SEAGATE 529MB 12ms 256K IDE.....\$782.       | EXTERNAL SCSI HD Parallel Kit w SW..\$189.   |
| MICROPOLIS 1.05GB 10ms 512K IDE.....\$1199.  | DPT SmartCache III SCSI-2 H/F Kit.....\$299. |
| EXTERNAL IDE HD Parallel Kit w SW.....\$169. | ADAPTEC 1542C SCSI-2 H/F Kit.....\$349.      |

#### CASES & POWER SUPPLIES & KEYBOARDS

Mini Tower/DeskTop w 200W CSA.....\$99. | Full Tower w 300W, 10 Bay, 2Fan...\$199.  
Honeywell/Keytronics 101 Enhanced...\$49. | ED120 Ext HD Case HH 45W SCSI.....\$139.

#### MEMORY UPGRADES - COMPUTERS & HP LASERS

4 MB x 9 SIMM 60ns.....\$209. | 1 MB x 9 SIMM 60ns.....\$59.  
1 MB MEMORY UPGRADE, HP/III.....\$99. | 4 MB MEMORY UPGRADE, HP 4.....\$299.  
4 MB MEMORY UPGRADE, HP/III.....\$269. | POSTSCRIPT UPGRADE HP.....\$379.

#### CO/PROCESSORS/UPGRADES Intel~Cyrilx~LAVA

Cyrilx 387/DX/40.....\$89. | Cyrilx 387/SX/33.....\$79.  
16550 UART 2S, 1BDP Board.....\$49. | Intel 486/DX/33,50,2/66.....SCALL.

#### MULTIMEDIA/CD ROM & REMOVABLE MEDIA DRIVES

PC Powered 150MB 18ms Ext Drive.....\$499. | NEC MultiSpin 3Xe CD ROM SCSI...\$759.  
PHILIPS CD ROM Int Kit 350ms 300KB.....\$279. | NEC MultiSpin 3Xi CD ROM SCSI...\$659.  
Syquest 88MB 20ms R/W 44MB Int Drive.....\$499. | Toshiba 3401B Int 200ms SCSI-2.....\$499.  
Syquest 105MB 20ms 3.5" SCSI Int Drive.....\$659. | All CD Sound Dimension Multimedia.....\$349.

#### MODEMS/FAX/VOICE CARDS & SWITCHES

TyIn2000 9600 FAX/2400 Modem V.42 bis MNP5/Voice/Business Audio,Int.....\$179.  
GVC 14.4 External S/R FAX/Modem, DOS/Windows, V.42/32bis/MNP5, 57,600bps...\$199.  
INTEL SATISFACTION MODEM/FAX 100/200/300/400/400e Int/External.....SCALL.  
Fax Line Manager 202 FAX/PHONE/MODEM on 1 Line, Smart/Auto Answer.....\$149.

#### TAPE DRIVES Archive~IOMEGA~Colorado~Connor

Colorado JUMBO 250MB Int Tape Drive.....\$239. | CONNOR 250MB Int Tape Drive.....\$199.

#### VIDEO / TV CARDS

DIAMOND STEALTH SVGA, 1280x1024, 16 bit, 72Hz, 1MB, 32K Colors.....\$239.00  
VIDEO BLASTER FULL-Motion VIDEO & TV, 2M Colors, MS Video, Animation...\$439.00  
ATI Wonder XL24 SVGA, 1024x768, 1 MB, NI, 72Hz, Mouse, 16.7M Colors, 8/16bit...\$159.00  
Hercules DYNAMITE PRO 2MB, ISA/VESA, 1280x1024, NI, 87Hz, 16M Colors...\$289.00  
ATI VGA Wonder GT Windows Accelerator 1280x1024, 1.5MB, NI, 76Hz, Mouse...\$239.00  
CIRRUS LOGIC 1MB, VESA Local Bus, 1280x1024, NI, 72Hz, 16M Colors...\$129.00  
ATI Graphics ULTRA Pro 1280x1024, 2MB, NI, 76Hz, Mouse, 16M Colors...\$439.00

#### POS SOLUTIONS - BAR CODING, SCANNERS, SOFTWARE

KeyBoard Wedge WAND Scanner.....\$329.00 | POS CASH DRAWER w Dual LOCK...\$189.00  
STAR 4.5" SERIAL POS PRINTER.....\$475.00 | UTILITY 1 BAR CODE Software.....\$179.00  
CREDIT/HEALTH CARD READER.....\$275.00 | POS KEYBOARD, 44 Key Prog.....\$195.00  
CCD HAND LASER SCANNER.....\$977.00 | POS ACCOUNTING Software.....\$375.00

#### MULTI I/O, RAM, CONTROLLER CARDS, FANS, MOUSE

RAMpAT! AT PLUS RAM Board OK->16MB, SIMMS, EMS 4.0, 286/386/486.....\$139.00  
KeyTronic PROFESSIONAL MOUSE, Serial w Adapter & SW, 2B.....\$19.00  
LAVA COMPLETE 16 bit IDE, FDD, 2 Serial (16550 UART), 2 Parallel.....\$79.99  
ECS CI 92 AT I/O, 2 Serial, Parallel, FDD, Game, HD IDE, w Cables...\$39.99  
GCW757VL VESA Local Bus Multi I/O, 2 S,P, FDD, Game, IDE, Cables.....\$59.99  
ST01/ST11R 8 bit SCSI/RLL Hard Disk Adapter Cards.....\$69.99  
HFA-015 486 PROCESSOR HEAT SINK & FAN with Connector Cable...\$19.99

#### MAINBOARDS SX/DX 386/486 (ISA/VESA/EISA)

386DX/40 386DX, 40MHz, 128K Cache, OK, Exp>32MB, SIMM, 6Slot.....\$159.00  
486DLC/33 486DLC, 33MHz, w487DLC, OK, 128K Cache, Exp>32MB, AMI, SIMM, 6Slot...\$219.00  
486DX/40 486DX, 40MHz, 256K Cache, OK, Exp>32MB, AMD, OPTI, AMI, SIMM, 6Slot...\$529.00  
486SX/25 486SX, 25MHz, OK, 64K Cache, Exp>32MB, Intel, OPTI, AMI, SIMM, 8Slot...\$299.00  
486DX/33 486DX, 33MHz, 256K Cache, OK, Exp>32MB, Intel, OPTI, AMI, SIMM, 8Slot...\$549.00  
P5486DX/33 VESA LB, P5 Socket, 256K Cache, OK, Exp>32MB, Intel, UMC, AMI, SIMM, 8Slot...\$579.00  
486DX2/50 486DX, 50MHz, OK, 256K Cache, Exp>32MB, UMC, SIMM, 8Slot.....\$699.00  
486DX/50 486DX, 50MHz, OK, 256K Cache, Exp>32MB, OPTI, SIMM, 8Slot.....\$779.00  
486DX2/66 486DX, 66MHz, OK, 256K Cache, Exp>32MB, UMC, SIMM, 8Slot.....\$829.00  
486DX/33 486DX, 33MHz, OK, 256K Cache, Exp>128MB, UMC, SIMM (EISA)...\$779.00  
486DX/33ve 486DX, 33MHz, OK, 256K Cache, Exp>128MB, UMC, SIMM (VE/EI/SA)...\$929.00  
486DX2/66 486DX, 66MHz, OK, 256K Cache, Exp>128MB, UMC, SIMM (EISA)...\$1089.00

#### MONITORS/PANELS MITSUBISHI~NEC~GOLDSTAR~SAMSUNG

NEC Monitors 3FGe, 4FGe, 5FG/P/e, 6FG.....SCALL.  
GS1455 14" SVGA .39 1024x768 I.....\$289.  
GS1460 14" SVGA .28 1024x768 I.....\$329.  
SC428TX 14" SVGA .28 1024x768 70Hz NI.....\$349.  
SC528DXL 15" SVGA .28 1024x768 72Hz FS NI.....\$519.  
DIAMOND SCAN 15FS .28 1024x768 NI 76Hz.....\$589.  
DIAMOND PRO 17" .26 1024x768 NI 76Hz.....\$1199.  
DIAMOND PRO 17FS .28 1280x1024 NI 76Hz.....\$1359.  
DIAMOND PRO 21FS .28 1600x1280 NI 76Hz.....\$2599.

#### PRINTERS & SCANNERS

HP DeskJet 500 / 500C, 550 Color.....from \$399.  
SAMSUNG Finalé 8000, 1200 dpi 6MB, 8ppm, PS...\$2299.  
CANON BJ-230 INK JET w ASF Supports 11"x17".....\$519.  
HP LASER PRINTERS - 4P, 4, 4M, 4L, 4ML.....SCALL.  
NEC 1097 10ppm, 7MB, 600dpi, Adobe PS 2/PC/Mac...\$1859.  
OKIDATA OL400e Laser Printer 4ppm, 512K.....SCALL.  
PANASONIC 1150, 2023, 2123, 2124 ETC.....SCALL.  
Golden IMAGE 800 dpi, 256 Gray Scale, OCR.....\$199.  
Mustek ColorArtistPro 800 dpi, 16.7M Colors, OCR...\$549.

#### SOFTWARE SALE

Norton AntiVirus 3.0.....\$79.  
MS DOS 6.2U.....\$59.  
Norton Speeddrive 4.0...\$79.  
IBM OS/2 2.1.....\$129.  
MS EXCEL 4.0 Win...\$149.  
QEMM-386 Ver 6.0...\$49.  
MS OFFICE 4.0.....\$349.  
WordPerfect 6U DOS...\$139.  
MS WORD 6.0 Win...\$149.  
WINDOWS 3.1.....\$69.  
Instant Artist Win...\$55.  
PC Tools Pro 9.0.....\$109.  
Norton Utilities 7.0.....\$89.  
Harvard Graphics Win2U...\$110.  
Quattro Pro 5.0 Win...\$63.  
WordPerfect Win 6.0...\$159.  
PARADOX Win 1.0...\$129.

128 Atlantic Avenue  
Toronto, Ontario M6K 1X9  
Phone: (416) 537-2611  
Fax: (416) 537-1484



### SYSTEM BUILDERS LIMITED

(4 Streets E. of King / Dufferin - Open Saturdays)

Order Desk 1-800-567-2611



128 Atlantic Avenue  
Toronto, Ontario M6K 1X9  
Phone: (416) 537-2611  
Fax: (416) 537-1484

## ANALYSIS

# Borland Works Toward Natural Workgroups

BY DAVID TANAKA

Borland's latest products — Quattro Pro 5.0 for Windows spreadsheet (reviewed elsewhere in this issue) and Paradox for Windows database software — are available in single user or workgroup editions. In the workgroup versions, Borland has implemented its unique interpretation of what workgroup computing should be.

The terms "workgroup computing" and "groupware" have entered computing's lexicon relatively recently. They refer to a class of software and new capabilities in existing software that promise to change the way users work on networks and across multiple networks. For example, groupware would enable users to collaborate simultaneously on a single project — housed in a word processing document or a spreadsheet file, for example — each from his or her own computer.

The mechanics of sharing and distribution were addressed early on by network operating systems, management software, and network hardware. A complete industry has arisen out of the desire to connect PCs together.

When it comes to addressing the way people work with each other across a network, however, the tools have been much slower in coming. The software that people use and the way they produce work on the network isn't that much different from the

way things are done on stand-alone PCs. For many users, file and printer sharing and E-mail are the main impact of networks.

Some companies, notably Lotus with its Notes (probably the best-known workgroup environment to date), saw the network as providing an opportunity for truly collaborative work, where the workgroup's product could be something greater than the sum of labors at the individual workstations.

Rather than taking an approach like Lotus did with Notes, Borland has said, wait a minute, workgroup computing should be a "natural" extension of the way people now work. It shouldn't impose another set of software on the user; it shouldn't be limited by the LAN; it shouldn't force people into new methodologies.

In its white paper on workgroup computing, Borland argues that workgroups should grow naturally from individual desktops and individual needs, and shouldn't require additional investments in hardware

or groupware. People should be able to participate in workgroup computing using the applications they are already familiar with.

To implement its vision, Borland has introduced Object Exchange, a workgroup engine that the company calls middleware. It allows individual users to share object such as a Paradox table or Quattro Pro spreadsheet page.

The sharing can take place among stations on a single LAN or across LANs. At present, Object Exchange is compliant with specifications for MCI Mail; Novell's NetWare Message Handling Service (MHS) and NetWare Global Messaging (NGM); Microsoft's Mail Application Programming Interface (MAPI); and works with most popular LAN software. In the future it will support the Vendor Independent Messaging (VIM) standard.

**The terms "workgroup computing" and "groupware" refer to a new capabilities in software that promise to change the way users work on networks and across multiple networks.**

"Workgroup solutions should let you share whatever live data you want, whenever you want, with whoever you want, wherever you're located," Borland states in the white paper.

The methodology to activate Object Exchange is "Publish and Subscribe," a term Borland lifted from Apple's System 7. A publisher grants access to a Quattro Pro spreadsheet page by "publishing" it through Object Exchange. Users can "subscribe" to that object by inserting the page into their spreadsheets.

In Borland's workgroup-enabled versions of Quattro Pro and Paradox, the Object Exchange function is built in, along with a user interface called the Workgroup Desktop. The Desktop comes with a menu bar (or "speedbar" in Borland'speak) that allows one-click access to the Object Exchange services.

Later this year Borland plans to introduce a Workgroup Enabling Kit which will allow access to the Object Exchange application programming interface (API). This will allow software developers to implement Object Exchange in their applications. Borland also claims the kit will allow power users to implement Object Exchange in existing programs through the program's macro language. ■

Contact: Borland Canada, 416-229-6000.

intel

CONNER

GENICOM

hp HEWLETT  
PACKARD

IBM

NEC

Microsoft+

MITSUBISHI

Canon

PC  
Multimedia PC

Kodak

Kodak



**PANASONIC**  
DUAL - SPEED CD-ROM  
306K+/SECOND DTR

**\$299**  
w/interface



MAXTOR 212MB IDE  
Hard Disk Drive

**\$275**

TOSHIBA 1.05Gb SCSI-II  
**\$899**

TOSHIBA 1.2Gb SCSI-II  
**\$1149**

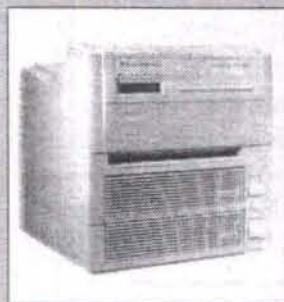

300DPI Laser Printers  
from

**\$699**

600DPI Level II PostScript®  
6MB RAM, 20MHz RISC, AES

**\$1999**

## COMPLETE 486 WORKSTATION IDEAL FOR A SO/HO!

- All systems based on a 40MHz 486 CPU
- 4MB RAM, for Windows™ applications
- 3½" 1.44MB High Speed FDD
- 105MB IDE Hard Disk drive
- Super VGA Graphics Board
- 14" Colour Super VGA monitor, tilt/swivel
- 101Key Spill Resistant keyboard
- Desktop or Mini-tower case /200W PS

### ALSO INCLUDES

**Laser Quality printer**  
with cable



**\$1,398.88**

### PERIPHERALS/ACCESSORIES

|                         |              |
|-------------------------|--------------|
| US Robotics 14.4 int    | <b>\$209</b> |
| CD-ROM drives from      | <b>\$279</b> |
| #9 Gxe Level 11,        |              |
| VL-Bus, 2MB VRAM        | <b>\$529</b> |
| Tape Backup drives from | <b>\$229</b> |

Inquire about our  
Engineering/CADD  
WorkStations

from **\$4999**

**238-1238**

TTI

**TTI Computers & Business Equipment**  
Southcreek Business Park, 3045 Southcreek Rd.  
Units #23 & 25, Mississauga

All items may not be exactly as illustrated. Some units may be end-of-product lines, or display units. Quantities may be limited on some items. Financing and leasing available. Please call for eligibility and rate information.

MAG

LOCATION

FUJITSU

Panasonic

hp HEWLETT  
PACKARD

**Spreadsheets**  
Continued from page 38

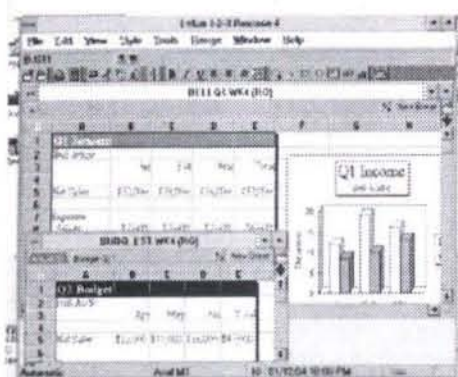

Lotus 1-2-3 version 4 sports the tabbed worksheets first popularized in Quattro Pro eyes away from the rest of the spreadsheet. Charting has been improved with a one-step process in which 1-2-3 tries to make intelligent choices on data labels, legends and titles for charts. You merely highlight a range of data, click on a graph icon and presto, there is your completed chart.

Traditional Lotus users now have valid reasons to switch to 1-2-3 for Windows. It is a solid program that provides enhanced functionality and ease of use.

Microsoft Excel 5.0 is a spreadsheet that continues to dazzle with each new release. Version 5.0 is a major upgrade that improves overall useability and provides advanced analysis tools.

Excel finally provides true 3-D spreadsheets, complete with nameable tabs like those in 1-2-3 and Quattro Pro. By default, a spreadsheet has 16 sheets although you can easily add more or change the default number. Sheets in a workbook can be normal worksheets, chart sheets, dialog box sheets, Visual Basic modules or XML macro sheets. Although Excel 5.0's macro language is Visual Basic for Applications, it still supports Excel 4.0's macro language.

Dozens of useful features make common tasks easier. If you need to sort a range of data, there is no need to specify the range first. Excel determines what you want to sort and displays the range in a dialogue box.

The toolbars almost eliminate the need to click on menus. Several of the toolbar icons are actually list boxes that also function as tear-off palettes. For example, when you are formatting your work, you can tear off the font color and background color palettes and keep them close at hand.

Wizards, which walk you through the steps required to perform a task, have been expanded and include several powerful new ones. The one I like best is the Function Wizard which helps you use any of the 200 worksheet functions. Importing a text file is now a breeze with the text-import Wizard. The PivotTable Wizard allows you to create and customize summary tables of data.

Other new features include a drag-and-drop function to bring new data into existing charts instead of having to create a new one. Automatic sub-totals and an auto filter feature provide easier methods of viewing data. Finally the Tip Wizard monitors your work and provides suggestions on easier methods of completing tasks.

Excel 5.0 is a real winner. Once again it sets the standard for spreadsheet programs.

**What About DOS?**

Improv, CA-Compete and the upgrades to Excel, Quattro Pro and Lotus 1-2-3 provide significant enhancements for the Windows

user, but what about the dedicated DOS users; are they really out in the cold now? Not in the short term, but the days of DOS spreadsheets are numbered.

Quattro Pro For DOS provides new functionality for the DOS user and the new Lotus 1-2-3 Release 4 for DOS will provide significant enhancements when it ships in March. A new interface will include worksheet tabs on the various pages of a three-dimensional spreadsheet; a status bar that allows users to

change fonts, colors, and other attributes; and the Version Manager which lets users save and manipulate different worksheet scenarios. In addition, the product will offer a spell checker, and printer and performance enhancements.

For spreadsheet users, 1994 is a banner year. Power users can consider moving to high-end multidimensional modeling programs like Improv and CA-Compete. Mainstream spreadsheet users can explore the lat-

est versions of the popular Microsoft Excel, Lotus 1-2-3 for Windows and Quattro Pro for Windows releases. And DOS users will have new updates to the old familiar Lotus and Quattro Pro programs.

With new features and increased ease of use, the spreadsheet products just keep getting better and better.

Alan Salmon is managing director of Toronto-based Salmon & Associates.

# Be a computer programmer!

## Only NRI gives you hands-on training with the latest programming tools:

- A 486sx computer with Super VGA color monitor, 200 meg hard drive
- Windows
- Visual Basic
- Power C
- QBasic
- DOS
- And much more!

**O**nly NRI at-home training gives you real-world programming skills in three in-demand languages: QBasic, C, and Visual Basic, today's hot new language designed for writing popular Windows applications. Best of all, you get hands-on training with a powerful Intel-based 486sx computer system, complete with Super VGA color monitor, 200 meg hard drive, Windows, and professional programming software you keep!

**NRI, the leader in at-home computer training, shows you how to take advantage of today's newest programming opportunities**

Get in on the ground floor of computer programming one of today's fastest-growing career fields. The Bureau of Labor Statistics forecasts that job opportunities for programmers will increase much faster than average over the next 10 years, with as many as 400,000 new jobs opening up by 2005.

And the fastest-growing segment of programming jobs will be PC programming, fueled by the phenomenal popularity of Windows, the efficient power of C, and the ascent of exciting new languages like QBasic and Visual Basic.

Now, with NRI at-home training, you can get the new skills you need to build a top-paying career — even a full- or part-time business of your own — in this high-growth, high-opportunity field.

**Get hands-on experience with today's programming tools: a powerful 486sx computer, Super VGA color monitor, 200 meg hard drive, Windows, Visual Basic, and more — all yours to keep!**

Right from the start, NRI's unique Discovery Learning Method gets you actively involved in the challenge of real-world programming. Step by step, you learn to create the kinds of full-featured, powerful programs today's employers



and clients demand...including programs designed for use in a Windows environment!

Only NRI gives you first-hand programming experience with a state-of-the-art Intel-based 486sx computer system, complete with Super VGA color monitor, 200 meg hard disk drive, a full megabyte of RAM, 1.44 meg 3.5" floppy drive, mouse, and more — all yours to train with and keep!

Plus you explore the extraordinary capabilities of three in-demand programming languages. You learn to design, code, run, debug, and document programs in QBasic, C, and Visual Basic. Best of all, since Visual Basic is specifically designed for creating Windows applications, you learn to generate fully functioning Windows programs, complete with text boxes, command buttons, and other sophisticated graphical interface elements.

**No previous experience necessary**  
Train with NRI, and immediately start getting the money-making job skills you need to be a computer programmer — no matter what your previous background.

NRI's step-by-step lessons and hands-on programming projects help you first master the design concepts used every day by successful PC programmers. Then, with the support of your experienced NRI instructor, you quickly move on to learn programming in three of today's hottest languages.

By the time you complete your course, you have a clear understanding of programming methods, languages, and techniques... and you're ready to handle any programming task with confidence.

**Send today for your FREE catalog**

See how NRI at-home training gives you the programming know-how, the computer, and the software you need to get started in this top-paying field. Send today for your FREE catalog!

If the coupon is missing, write to us at the NRI School of Computer Programming, McGraw-Hill Continuing Education Center, 300 Water Street, Whitby, Ontario L1N 9B6.

IBM PC/AT is a registered trademark of the IBM Corporation. Windows, QBasic, and Visual Basic are trademarks of Microsoft Corporation. Intel Inside logo is a registered trademark of Intel, Inc.

**SEND TODAY FOR FREE NRI CATALOG!**

**NRI Schools**  
McGraw-Hill Continuing Education Center  
300 Water Street, Whitby, Ontario L1N 9B6.

- Check one FREE catalog only
- COMPUTER PROGRAMMING
  - PC Applications Specialist
  - Programming in C++ with Windows

- Other Computer Career Courses**
- Microcomputer Servicing
  - Desktop Publishing
  - Bookkeeping and Accounting
  - Multimedia Specialist

Name \_\_\_\_\_ (please print) Age \_\_\_\_\_

Address \_\_\_\_\_

City/Prov./Code \_\_\_\_\_

5520-0294



**Back to School Special!**  
**IBM 486SLC2-66MHz**

(Faster than 486DX-33, LandMark 2.0 - 153MHz)  
- 16K Internal cache, Made in USA, 4 MB RAM  
- 1.2 & 1.44M FD, IDE Controller w/2S/P/G  
- 1MB SVGA card, SVGA Color Monitor .28dpi  
- 170M Hard Drive, 101 Enhanced Keyboard  
- Mini Tower case, IBM DOS 6.1, Mouse & Pad  
- Heat Sink & CPU Fan, Math-Co

**ONLY \$1399**  
3 years parts & labour limited warranty

Toronto Branch: 1125 Dundas St. East, Suite 28, (2nd Floor) Mississauga, Ont., L4Y 2C4  
Tel: (416)-279-5038 Fax: (416)-279-9241  
Head Office: 1117 St. Catherine W. Suite 407 Montreal, Quebec H3B 1H9  
Tel: (514)-286-1516

**Special of the Month**

- 1.44 Pre-Formatted Diskette \$4.95
- Logitech SoundMan 16 \$165
- Zoltrix Sound Card w/Speaker \$70
- Zoltrix 96/24 Fax Modem (internal) \$65
- GVC 14.4 Internal Fax Modem (internal) \$160
- Mitsumi CD ROM (350ms) \$195
- Mitsumi CD ROM (250ms) \$275
- IBM PC DOS 6.1 \$39
- IBM 486SLC2-66 MHz Main Board (16K Internal Cache, Made in USA, Math-Co, Heat Sink & CPU Fan) \$345

**STANDARD SYSTEMS**

- 4MB Ram(70ns)
  - 1.2M & 1.44M Floppy Drive
  - 256MB IDE Hard Drive
  - 1MB SVGA Video Card
  - IDE Controller 2S/P/G
  - 14" SVGA Interface Monitor .28dpi
  - 101 Enhanced Keyboard
  - Mini Tower Case
  - IBM DOS 6.1
  - Mouse & PAD
  - Vesa Mother Board
- |                            |        |
|----------------------------|--------|
| 386DX-40 w/128K Cache      | \$1279 |
| 486DLC-33 w/128K & Math-Co | \$1329 |
| 486DX-33 w/128K Cache      | \$1589 |
| 486DX-50 w/128K Cache      | \$1769 |
| 486DX2-50 w/128K Cache     | \$1639 |
| 486DX2-66 w/128K Cache     | \$1829 |
- 2 years parts & labour limited warranty

**VESA SYSTEMS**

- 4MB Ram(70ns)
  - 1.2M & 1.44M Floppy Drive
  - 256 MB IDE Hard Drive
  - 2MB Cirrus Logic VESA Video Card
  - VESA IDE Controller
  - 14" SVGA Non-Interface Monitor
  - 101 Enhanced Keyboard
  - Mini Tower Case
  - IBM DOS 6.1
  - Mouse & PAD
- |                        |        |
|------------------------|--------|
| 486DX-33 w/256K Cache  | \$1739 |
| 486DX-50 w/256K Cache  | \$1929 |
| 486DX2-50 w/256K Cache | \$1799 |
| 486DX2-66 w/256K Cache | \$1999 |
- 2 years parts & labour limited warranty

\* Prices are subject to change without notice. FINANCING AVAILABLE NOW !!



2950 Kennedy Rd., Suite 202, Scarb. (N. of Finch)  
Mon-Fri/Sat 10:30-7/5:00 Tel: (416) 297-6773  
Fax: (416) 298-6152

- |  |                                  |                        |
|--|----------------------------------|------------------------|
| 15" FS N.I. Monitor<br>340 MB HDD 12ms | 14" N.I. @ 1024x768<br>245MB HDD | 486SLC33/2M .....\$999 |
| 486 DX-33 ....\$1,888                  | 486 SX-33 ....\$1,445            | 386DX-40 .....\$1,099  |
| 486 DX-50 ....\$2,088                  | 486 DX-33 ....\$1,645            | 486DLC-40.....\$1,129  |
| 486 DX2-66 ..\$2,166                   | 486 DX2-66 ..\$1,925             | 486 SX-33.....\$1,199  |
|  |                                  | 486DX-33 .....\$1,399  |

**NEW! MasterMode VESA L.B. & PS Ready**

- 4MB RAM
- 128K Cache
- 1.2 & 1.44 FDD
- VESA L.B. IDE + I/O
- VESA L.B. 1MB Video
- Mini-Tower + 220W
- 101 Enhanced K/B
- MS/PC Mouse
- 2S/1P/1G Ports

**MultiMedia Package Special**

- CD-ROM 350ms + Ctrl + Sound Card + Spk ..... \$259
- CD-ROM Dual Spd + Ctrl + Sound Card + Spk ..... \$349

**What you need, is what we sell!**

- Sound Blaster Compatible ..... \$59
- 387DX-33 Math Co-processor ..... \$65
- Fax/Modem 96/24 S/R ..... \$49
- Fax/Modem 14.4/14.4 int/ext.....\$175/199
- 386DX-40 M/B + CPU.....\$149
- 486DX-VESA L.B. M/B.....\$129
- 3 1/2" /5 1/4" Floppy Drive ..... \$49/59
- IDE/SCSI/MFM Ctrl Card ..... \$22/139/35
- ATI Wonder XL 1M Video Card ..... \$129
- ATI Wonder GT/Graphic Ultra ..... \$229
- CL VESA L.B. 1 MB Video ..... \$109
- 14"/15"/17" SVGA...\$269/299/329/479/779
- Mini/Mid/Full Tower + Power .....\$65/95/125
- Epson AP3250 24 Pin Printer.....\$199

**Ask for monthly payments plan**

- \$239 Upgrade your systems**  
frm XT/286 to 386 SX-33MHz, 2M
- \$299 Network solutions**  
Link 2PC's to share CD-ROM, HDD, PRT etc  
incl: 2 Ethernet card, T, Netware Lite 1.1 etc
- Attn to CTC Customers in 1993**  
If you purchased over \$1000 last year, you  
have a chance to win a SONY Walkman  
(\$169) Call us for a drawing number before  
April 1st 1994
- Ethernet 16 Networking card.....\$79

\$30, Repair Monitors, Hard Drives and Computer Systems

**Quattro Pro**

Continued from page 42

drawback is that the program does not allow extensive editing of the graphs or charts you produce, but this may at least keep some people honest.

The thinking behind software these days seems to be "bigger is better," which translates to lots of hard disk space. If you choose a full install with the Workgroup version, you will require 20.7MB free on your hard drive.

Thankfully, Borland includes several options for installing the program, and a minimum install requires only 7MB. This means that you will be passing up the help facilities and most of the other tools, but if you intend to use the program for basic spreadsheet work, the minimum install is all you really need.

You are also given the option of installing select features, so you can choose only those functions that you think you will require.

Other software developers take note: Quattro Pro 5 for Windows also includes a handy Uninstall facility. It is not completely thorough (it does not remove its Windows group of icons by itself, and it does not remove itself completely from your Windows initialization file), but it is definitely a

step in the right direction.

The Workgroup Edition of Quattro Pro does boast features not available in the basic stand-alone version. It supports Structured Query Language (SQL) functions, and integrates with InterBase, Sybase and Oracle, making Quattro Pro 5.0 for Windows a good tool for requesting data across a network. It's Network Deployment tool lessens the task of installing the program across a network of machines. It also includes a spell-checker, which will help prevent you from producing sloppy-looking presentations.

Borland Canada has priced Quattro Pro 5.0 for Windows aggressively, in order to grab a large part of the spreadsheet market for themselves. The suggested retail price for the stand-alone version is \$129.95, though with various special offers you may be able to find it for as low as \$70.95. The Workgroup Edition is available for the suggested retail price of \$646.

The program is powerful and flexible enough for most users, and for the list prices, is a steal in comparison to similar products. Quattro Pro 5.0 for Windows is a worthy addition to the long line of spreadsheet programs, and has many features that point the way for future developments in this type of program. ■

Contact: Borland Canada (416) 229-6000

THE B.B.S THAT'S VIRTUALLY A CITY

- 256 COLOUR DATABASES
- MOUSE SUPPORT
- CITY SHOPPING
- CITY SERVICES
- CITY FUN



**NEXT MONTH : NEW AREA NEW NUMBER**

Annual Passports (incl.gst.&pst.)  
/BETA: \$46.00 1.5 hrs/day  
/GAMMA: \$57.50 2.5 hrs/day  
/ALPHA: \$69.00 unlimited

**CyberCity**

10023 Yonge Street,  
Richmond Hill, L4C 1P7  
Ontario, Canada.  
BUS : (905) 508-6222  
BBS : (905) 508-4087



**ALPHA PLUS COMPUTERS**

*Winter Special Sale*

- |                          |        |
|--------------------------|--------|
| MAXTOR 245MB H/DRIVE     | \$309  |
| MAXTOR 340MB H/DRIVE     | \$369  |
| QUANTUM 170MB H/DRIVE    | \$269  |
| QUANTUM 270MB H/DRIVE    | \$329  |
| WD Caviar 340MB H/DRIVE  | \$379  |
| WD Caviar 420MB H/DRIVE  | \$469  |
| MITSUMI CDROM FX001D     | \$269  |
| 1MB SIMM MODULE          | \$49   |
| MAG 15" MX15F MONITOR    | \$689  |
| NANAO 15" F340IW MONITOR | \$899  |
| NANAO 17" F550IW MONITOR | \$1699 |
| CANON BJ-200             | \$369  |
| CANON BJC-600 COLOR      | \$769  |
| AVERKEY NTSC ENCODER     | \$269  |
| AVER 2000 FRAME GRABBER  | \$379  |
| EPSON NOTEBOOK           |        |
| 386SL/25MHz 4MB/60MB     | \$1349 |

**VESA LOCAL BUS System**

- 486 DX-33 \$1949 • 486 DX-50 \$2129
- 486 DX2-66 \$2199

All Systems Come With:

- 256KB Cache
- 8MB Fast 70ns Memory
- 245MB Fixed Drive
- 1.2MB & 1.44MB Floppy Drives
- Cirrus Logic GD5428 1MB VESA Video Card
- 14" Non-Interlaced SVGA .28dp Monitor
- Mid-Tower Case w/230W CSA Power Supply
- Keytronic 101 Enhanced Keyboard
- VESA IDE Controller w/ 2S, 1P, 1G Ports
- Microsoft Serial Mouse
- Mouse Pad
- Warranty - 1yr. parts & 5yrs. labour



386 College St. • Toronto, Ont., M5T 1S7 • Tel:(416)323-0898 Fax:(416)323-1064

# MISSISSAUGA LOCATION OPENING SOON

# ABC COMPUTER

## SAMSUNG 24 PIN PRINTER \$175

### DOWNTOWN

161 JOHN STREET  
TORONTO, M5T 1X3  
TEL: (416) 979-3964  
FAX: (416) 979-5458

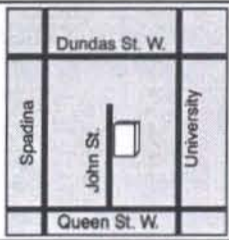

### MARKHAM

7170 WARDEN AVE.  
UNIT 17, L3R 5M8  
TEL: (416) 946-1613  
FAX: (416) 946-1957

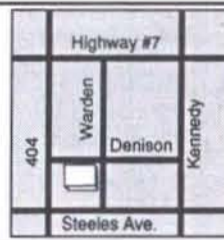

### SCARBOROUGH

4800 SHEPPARD AVE. E.  
UNIT 120, M1S 4N5  
TEL: (416) 321-0413  
FAX: (416) 321-0429



## VESA LOCAL BUS PREMIUM SERIES

### 486DX-50

\$ 1,799

- 245 Meg HD
- 14" SVGA .28dp NI 72Hz Refresh Rate (Toshiba CRT)

### 486DXII-66

\$ 2,079

- 340 Meg HD
- 15" SVGA Flatscreen .28dp NI Monitor

#### SYSTEM INCLUDES:

- 32 Bit VESA Local Bus Motherboard (Built-In Math-Co)
- 128k Cache (Max. 256K)
- 4 Meg Fast RAM
- 1.44 Meg Floppy Drive (Japanese)
- VESA Local Bus 32 bits 1 Mb SVGA Card
- Super IDE Controller
- 2S/1P/1G
- 101 Enhanced Keyboard
- Minitower case w/LED Display
- MS Compatible Mouse & Pad



WARRANTY: 2 YEAR LABOUR & PARTS

\$ 999

### 486SX-25

- 105MB HD
- Colour VGA Card
- 14" Colour VGA Monitor

### \$ 1,449 486DX-33/40

- VESA Local Bus Motherboard
- 245MB HD
- VESA Local Bus 1Mb SVGA Card
- 14" SVGA Monitor (1024x768)

#### SYSTEM INCLUDES

- 4 Meg Fast RAM
- 1.44 Meg Floppy Drive
- Super IDE Controller
- 2S/1P/1G
- 101 Enhanced Keyboard
- Minitower case w/LED Display

## COMPETITIVE VESA LOCAL BUS SERIES

• ALL PRICES ARE 4% DISCOUNTED FOR CASH, MONEY ORDER & CERTIFIED CHEQUE ONLY • PRICES SUBJECT TO CHANGE WITHOUT NOTICE •

#### HARD DRIVES

|                        |        |
|------------------------|--------|
| MAXTOR SCSI 877MB      | \$ 775 |
| MAXTOR SCSI 535MB      | \$1294 |
| MAXTOR SCSI2 540MB     | \$1074 |
| MAXTOR SCSI2 1.2GB     | \$1620 |
| QUANTUM SCSI2 245MB    | \$ 395 |
| QUANTUM SCSI2 525MB    | \$ 935 |
| QUANTUM SCSI 700MB     | \$1119 |
| QUANTUM SCSI2 1.05GB   | \$1384 |
| QUANTUM SCSI2 1.2GB    | \$1552 |
| SEAGATE SCSI2 344MB    | \$ 567 |
| SEAGATE SCSI2 420MB    | \$1018 |
| SEAGATE SCSI2 525MB    | \$1413 |
| SEAGATE SCSI 1.05GB    | \$1416 |
| SEAGATE SCSI2 2.1GB    | \$2509 |
| MICROPOLIS SCSI 560MB  | \$ 935 |
| MICROPOLIS SCSI 1.05GB | \$1305 |
| MICROPOLIS SCSI 1.75GB | \$1700 |
| TOSHIBA SCSI 877MB     | \$1011 |
| TOSHIBA SCSI 1.02GB    | \$1149 |
| TOSHIBA SCSI 1.2GB     | \$1199 |

#### CONTROLLERS

|                                   |        |
|-----------------------------------|--------|
| ADAPTEC 1522 SCSI HD/FD CARD ONLY | \$ 117 |
| 1522KIT SCSI CARD,S/W,CBL         | \$ 206 |
| 1542KIT SCSI CARD,S/W,CBL         | \$ 384 |

#### BOCA RESEARCH

|                          |        |
|--------------------------|--------|
| IDE PLUS 2S/1P/1G        | \$ 65  |
| I/O WITH 2 16C550 UART   | \$ 75  |
| I/O WITH 6 H SPEED RS232 | \$ 143 |

#### VIDEO CARDS

|                           |        |
|---------------------------|--------|
| ATI GRAPHIC ULTRA PLUS 1M | \$ 275 |
| ATI GRAPHIC ULTRA PLUS 2M | \$ 298 |
| ATI GRAPHIC ULTRA PRO 2M  | \$ 417 |
| ATI GR. ULTRA PRO 2M VL   | \$ 425 |
| ATI GR. ULTRA PRO 2M EISA | \$ 509 |

#### DIAMOND

|                         |        |
|-------------------------|--------|
| STEALTH PRO 1M VRAM ISA | \$ 339 |
| STEALTH PRO 2M VRAM ISA | \$ 457 |
| 24 BIT 1M DRAM ISA      | \$ 222 |
| STEALTH PRO 1M VRAM VL  | \$ 348 |
| STEALTH PRO 2M VRAM VL  | \$ 429 |
| 24 BIT 1M DRAM VL       | \$ 232 |
| VIPER 2M VRAM VL        | \$ 550 |

#### KEYBOARDS

|                        |       |
|------------------------|-------|
| ENHANCED 101           | \$ 24 |
| KEYTRONIC 101          | \$ 58 |
| HONEYWELL 101 ENHANCED | \$ 55 |
| FUJITSU 101 ENHANCED   | \$ 57 |

#### MATHS-CO PRO

|                     |       |
|---------------------|-------|
| 80387SX-16,20,25,33 | \$ 80 |
| 80387DX-25,33,40    | \$ 95 |

#### MEMORY

|                |      |
|----------------|------|
| SIMM 256K 70NS | CALL |
| SIMM 1MB 70NS  | CALL |
| SIMM 4MB 70NS  | CALL |
| SIPP 1MB 70NS  | CALL |
| DRAM 41256-80  | CALL |
| DRAM 44256-70  | CALL |
| DRAM 411000-70 | CALL |

#### MONITORS

|                                 |        |
|---------------------------------|--------|
| DAEWOO 15" FS 1024X768 0.28 N-I | \$ 499 |
| 17" FS 1280X1024 0.28 N-I       | CALL   |
| 21" FS 1600X1280 0.28 N-I       | CALL   |

#### PHILIPS

|                           |        |
|---------------------------|--------|
| 15" FS 1024X768 0.28 N-I  | \$ 585 |
| 17" FS 1280X1024 0.25 N-I | \$1240 |
| 21" FS 1600X1280 0.28 N-I | \$3090 |

#### MITSUBISHI

|                  |        |
|------------------|--------|
| DIAMOND SCAN 16  | \$1625 |
| DIAMOND PRO 17   | \$1322 |
| DIAMOND PRO 20   | \$2473 |
| DIAMOND PRO 21FS | \$2810 |

#### NEC

|      |        |
|------|--------|
| 3FGE | \$ 819 |
| 4FGE | \$ 950 |
| 5FGE | \$1495 |
| 6FG  | \$3070 |

#### ORCHESTRA

|                          |       |
|--------------------------|-------|
| 15" FS 1024X768 0.28 N-I | \$499 |
| 17" FS                   | CALL  |

#### CASES

|                           |       |
|---------------------------|-------|
| DESKTOP / 220W P.S.       | \$65  |
| MINI-TOWER / 220W P.S.    | \$65  |
| MINI-TOWER DISPLAY / 220W | \$70  |
| MED-TOWER DISPLAY / 220W  | \$105 |
| FULL TOWER DISPLAY / 250W | \$140 |
| 220W POWER SUPPLY         | \$45  |
| 250W FULL SIZE P.S.       | \$ 70 |

#### PRINTERS

##### RAVEN

|                          |        |
|--------------------------|--------|
| RP9105 9 PIN OPT. COLOR  | \$ 190 |
| RP2405 24 PIN            | \$ 246 |
| RP2406 24 PIN OPT. COLOR | \$ 279 |
| RP2420 24 PIN 256CPS     | \$ 370 |
| PR9606 9 PIN WIDE        | \$ 445 |
| PR2465 24 PIN WIDE       | \$ 438 |
| LP470PS 4PPM LED SLIM    | \$1125 |
| LP510 5PPM LASER 512K    | \$ 695 |
| LP530 5PPM LASER 1M      | \$ 929 |
| LP570PS POSTSCRIPT 2M    | \$1475 |
| LP1030 10PPM LASER 1M    | \$1367 |
| COLOR KIT FOR 2406,9105  | \$ 55  |

##### CANON

|                       |        |
|-----------------------|--------|
| BJ10EX W FEEDER       | \$ 335 |
| BJ200 W FEEDER        | \$ 355 |
| BJ230 W FEEDER WIDE   | \$ 529 |
| BJ330 W FEEDER WIDE   | \$ 659 |
| BJC600 W FEEDER COLOR | \$ 780 |
| BJC820 W FEEDER COLOR | \$1389 |

##### HEWLETT PACKARD

|                      |      |
|----------------------|------|
| HP DESKJET 500C      | CALL |
| HP DESKJET 550C      | CALL |
| HP4L 300DPI 1M LASER | CALL |
| HP4 600DPI 2M LASER  | CALL |

##### EPSON

|                          |        |
|--------------------------|--------|
| LQ570 24 PIN 252 CPS     | \$ 332 |
| LQ870 24 PIN 330 CPS     | \$ 616 |
| LQ1070 24PIN WIDE 225CPS | \$ 510 |

#### MULTI MEDIA

##### CREATIVE LAB

|                             |        |
|-----------------------------|--------|
| SOUND BLASTER PRO DELUXE    | \$ 145 |
| SOUND BLASTER 16            | \$ 205 |
| SOUND BLASTER 16 ASP        | \$ 285 |
| EDUTAINMENT CD 16 KIT D/S   | \$ 678 |
| OMNI CD UPGRADE KIT D/S     | \$ 450 |
| DIGITAL EDGE CD M/M KIT D/S | \$ 880 |

##### ATI

|                              |        |
|------------------------------|--------|
| FX-CD CARD, MITSUMI CD ROM   | \$ 365 |
| PHILIPS CM405 CD ROM         |        |
| INT. 265MS, MPC, PHOTO, SCSI | \$ 535 |
| SONY CDU561 CD ROM           |        |
| INT. 280MS, MPC, PHOTO, SCSI | \$ 560 |
| TOSHIBA XM3401B CD ROM       |        |
| INT. 200MS, MPC, PHOTO, SCSI | \$ 535 |
| CHONON CDS535 CD ROM         |        |
| INT. 280MS SCSI W CONTROLLER | \$ 520 |

##### FAX/MODEM

|                    |       |
|--------------------|-------|
| 9600/2400 INT. S/R | \$ 58 |
|--------------------|-------|

##### ATI

|                         |        |
|-------------------------|--------|
| INT. 14.4 BPS FAX/MODEM | \$ 200 |
| EXT. 14.4 BPS FAX/MODEM | \$ 240 |

##### US ROBOTICS

|                        |        |
|------------------------|--------|
| 14.4 BPS INT SPORTSTER | \$ 230 |
| 14.4 BPS EXT SPORTSTER | \$ 260 |
| COURIER 16.8 BPS INT.  | \$ 685 |
| COURIER 16.8 BPS EXT   | \$ 745 |
| COURIER HST/DS INT.    | \$ 969 |
| COURIER HST/DS EXT.    | \$1039 |

**OBITUARY**

# IBM Pioneer Dies At Age 79

BY GRANT BUCKLER

GREENWICH, CT (NB) — Thomas J. Watson Jr., the president of IBM from 1952 to 1961 and chairman from 1961 to 1971, died after a stroke Dec. 30. He was 79.

Watson, who was also United States ambassador to the Soviet Union in the final months of the Carter administration, died at

Greenwich Hospital in Connecticut. He was the son of Thomas J. Watson Sr., who joined the Computing-Tabulating-Recording Co. as general manager in 1914 — the year Watson Jr. was born in Dayton, Ohio — and transformed it into International Business Machines Corporation, later to be known by

the acronym IBM.

Watson Jr. came to work for IBM in 1937 at the age of 23, served in the US Air Force from 1940 to 1946, then returned to IBM, where he was promoted to president six years later. He became chief executive in 1956, taking over the post from his father

shortly before Watson Sr.'s death.

After stepping down as chairman and chief executive in 1971, Watson remained as chairman of IBM's executive committee until 1979, when President Jimmy Carter named him ambassador to the Soviet Union. He remained in that post until Ronald Reagan became president at the beginning of 1981, then returned to IBM as a director and chairman emeritus. He was a director of the company until 1984.

Though Watson Jr.'s rise at IBM clearly had a good deal to do with his parentage, he made his own mark on the company by moving it rapidly into the computer industry. Watson saw an opportunity for IBM, which had built its business on office equipment, to use its established sales force and reputation as a stepping stone into the emerging computer market in the 1950s.

Watson Jr. was later quoted as saying IBM's established sales force and its experience at installing and maintaining complex punchedcard accounting systems were "probably four times as important" as knowing how to build computers.

Though said to be a less hard-driving boss than his father, Watson Jr. preserved at IBM a formal, buttoned-down image that has only begun to fade in the past few years. During his tenure, as during his father's, IBM employees were known for an almost universal uniform of blue suit, white shirt, and tie.

It is said that Watson once said company employees wore such clothes because "business has been so good since we started wearing them 40 years ago that we're afraid to take them off."

Business was indeed good during Watson Jr.'s tenure at IBM. Between 1956, when he became chief executive, and his resignation in 1971, the company grew from 72,500 employees to about 270,000, and its

He is survived by his wife Olive, six children, and 15 grandchildren. ■

## MULTIMEDIA UPGRADE SPECIAL

**Panasonic 562 Double Speed CD Rom  
Sound Blaster Pro Card with Speakers  
Multimedia Encyclopidia & Family Choice CD**

OR

**Panasonic 562 Double Speed CD Rom  
Sound Blaster 16 Basic Card with Speakers**

**\$ 439**

### 386 / 486 SYSTEMS

Intel CPU (486's),  
128K Cache, 4MB Ram,  
Panasonic 1.44MB Floppy Drive,  
Quantum 170MB IDE Hard Drive,  
IDE I/O, 25/1P/1G Ports,  
Trident 512K SVGA Adaptor,  
14" Low Radiation SVGA monitor  
(1024 x 768, 0.28 Dot),  
Enhanced 101 Keyboard,  
MS Compatible Mouse,  
Mini Tower Case with 200W Power Supply.

### 486 LOCAL BUS SYSTEMS

**Pentium Upgradable ZIF Socket  
USA Made VESA Local Bus Board**

Intel CPU,  
128K Cache, 4MB Ram (70ns),  
Panasonic 1.44MB Floppy Drive,  
Quantum 270MB IDE Hard Drive(12ms),  
Cirrus Logic VLB 1MB Adaptor (upgradable to 2MB),  
VLB IDE Controller, 25/1P/1G Ports,  
14" Non Interlace SVGA monitor  
(1024 x 768, 0.28 Dot),  
Enhanced 101 Keyboard,  
MS compatible 3-button Mouse,  
Mini Tower Case With 230W Power Supply.

### DX33

**\$ 1389**

### DX2-66

**\$ 1839**

SX-33 \$ 1189  
DX-50 \$ 1599  
386DX-40 \$ 1079

DX2-50 \$ 1459  
DX2-66 \$ 1659

SX-25 \$ 1379  
SX-33 \$ 1419

DX-33 \$ 1589  
DX2-50 \$ 1659

**2 Years Parts & Labour Warranty**

#### CD Titles

Dinosaur/Space Adventure \$ 39  
Battle Chess \$ 23  
World Atlas \$ 27  
Grolier's Encyclopedia \$ 55  
Carmen Sandiego \$ 35  
Mother Goose \$ 28  
Family Health \$ 34  
Space Quest \$ 31  
Wing Commander \$ 26  
Sleeping Beauty \$ 27  
Shakespeare \$ 24  
French Games \$ 36  
Family Choice \$ 28

#### Hard Drives

Maxtor 210 MB \$ 279  
Quantum 270 MB \$ 329  
Maxtor 340 MB \$ 389  
Seagate 450 MB \$ 549  
Quantum 540 MB \$ 759

#### Scanner/Modem

Logitech Scanman 32 /OCR \$ 169  
Logitech Scanman 256 \$ 219  
HP Scanjet 11P \$ 999  
9624 S/R Fax Modem \$ 60  
14.4 S/R Fax Modem \$ 189

#### Printers

Panasonic 1150 9 pin \$ 179  
Panasonic 2030 24pin \$ 249  
Canon BJ200 \$ 359  
Oki Laser 400E \$ 669  
HP 4L Laser \$ 919

#### Networking

16 Bit Ethernet Card \$ 99  
16 Bit 10 BaseT Card \$ 109  
Lantastic 2 User Kit \$ 459  
Win Workgroup Kit \$ 489

#### Multimedia

Sound Blaster Pro Comp. \$ 69  
Sound Blaster Pro Deluxe \$ 149  
Sound Blaster 16 Basic \$ 179  
Panasonic 562 CD Rom \$ 259  
Micro Video Capture Board \$ 389

#### Monitors

Viewsonic 14" NI \$ 429  
Daewoo 15" NI \$ 489  
Mitsubishi 15" NI \$ 599  
Mitsubishi 17" NI \$ 1189

## Softec business computer

7170 Warden Avenue, Unit 19, Markham, Ont., L3R 8B4

TEL: (905) 477-9838

FAX: (905) 477-7887



## Underachieving PCs?

Michael Dell, founder and CEO of Dell Computer Corp. in Austin, TX took a swipe at the PC industry recently, suggesting that it has been an underachiever when it comes to creating products that address the real-world needs of its customers.

Dell said what's needed is a product development and marketing model where companies would deliver a product that meets specific customer requirements. He said the prevailing approach is to develop and market new products based primarily on leapfrogging technology, and on a set of arcane (to the customer) specifications.

"Most people don't buy a VCR based on a specification sheet," said Dell. "We need the PC equivalent of the VCR-Plus."

Dell made his comments at the 1994 Personal Computer Outlook conference held in San Francisco. ■

# Video For Windows 1.1 Improves Image Playback

BY LINDA ROHRBOUGH

SUNNYVALE, CA (NB) — Video for Windows 1.1 from Microsoft includes Supermac's video compression/decompression (codec) technology, called Cinepak, as well as the Intel codec Indeo. Aimed at multimedia developers, Microsoft claims the new version offers better digital image quality and is widely supported.

Key features of the new version include: improved video playback performance with 30 frames-per-second playback in a 320 by 240 picture element (pixel) window; utilities for playing back Video for Windows files on Apple Computer's Macintosh hardware platform; utilities for converting files in Apple's video playback format Quicktime to Video for Windows; support for multiple streams of information, such as audio and video, in a single Video for Windows file; and compression of audio.

Jonathan Roberts, group product manager for Windows at Microsoft, said: "We've improved the image quality, made the architecture more flexible, and provided tools to support cross-platform development. We're making it even easier for third parties to create compatible products, and giving developers the ability to add interesting functionality to their applications and titles."

According to Microsoft, developers will be able to take advantage of functions that include the ability to add multiple language

tracks in a single Video for Windows file, or spin, flip, shrink, or dissolve video images. In addition, a new clip art library is included, as is the ability to capture screens for use in self-running demos or training applications.

The new Cinepak codec in Video for Windows 1.1 can compress full-length movies on compact disc read-only memory (CD-ROM) discs, according to Supermac. The company has licensed the codec to Apple Computer, Atari, Cirrus Logic, Creative Labs, Sega of America, 3DO, and Weitek.

End users will be most likely to see the new version of Video for Windows in run-time software or included with new multimedia computer systems. Manufacturers Gateway, Packard Bell, Toshiba, and IBM are pre-installing the run-time portion of Video for Windows on new systems.

In addition, developers tools such as Adobe's Premier, ATI Technologies' Medi-merge, Digital Media's Spice 2.0, and Gryphon Software's Morph support Video for Windows, as does hardware from Intel, Media Vision, and Creative Labs.

Video for Windows 1.1 is available for US\$199 to developers from Microsoft directly. End users may download the run-time version from Microsoft's CompuServe forum.

Contact: Microsoft Canada 905-568-0434

# FAX ON DEMAND

Your business, small or large, has an important message to deliver. FAX ON DEMAND provides your existing and prospective customers with immediate access to information, 24 hours a day, 7 days a week.

- Brochures
- Price Lists
- Application Forms
- Hot Line Support
- Information Library
- Specials

High performance, low cost, DOS based, FAX ON DEMAND and Voice Mail system, featuring fully interactive voice prompts, Fax Broadcasting and many more features.

**For more information call 1-800-263-0215**

**FAXCESSORIES INC**  
THE "FAX SOLUTIONS COMPANY"

871 Victoria St N.,  
Kitchener, Ont. N2B 3S4

IBM AST NEC MITSUBISHI COMPAQ Canon HEWLETT PACKARD PERIPHERALS SOFTWARE

Here's Where You Find The



**COMPAQ PRESARIO 425**

4MB RAM, 200MB Hard Drive  
SVGA COLOR MONITOR INCLUDED  
FAX/MODEM w/ VOICE MESSAGING  
READY-TO-RUN SOFTWARE PACKAGE  
ENERGY STAR COMPLIANT  
SPACE SAVING DESIGN

~~\$1,769~~

**COMPAQ + Canon BJ-200**

COMPLETE PACKAGE  
IDEAL FOR ANY HOME OR OFFICE

~~\$2,464~~



## NOTEBOOKS

- AST NB 4/25S-123W
- ONO \$ 2,275.00
- COLOR \$ 3,095.00
- COMPAQ CONTURA
- 486/25 MD 120/W
- MONO \$ 2,545.00

## MULTIMEDIA from CREATIVE LAB

The Complete Multimedia Solutions

- DISCOVERY CD 16 KIT \$ 627.00
- EDUTAINMENT CD 16 KIT \$ 715.00



486 DX/33  
4MB RAM  
1.44 MB FLOPPY DRIVE  
170MB HARD DRIVE  
SVGA COLOR MONITOR  
DOS /WIN /MOUSE  
FREE SOFTWARE  
**HURDLA CMB \$ 2,095.00**

### SERVICE & SUPPORT

- WE REPAIR AND UPGRADE MOST MAKE OF PC
- AUTHORIZED COMPAQ & AST SERVICE CENTER
- NOVELL NETWORKING

Offer valid until February 15 1994

All prices are cash discounted, quantity limited, prices are subject to change.

## SOFTWARE

- MS WORD U/G \$ 126.00
- MS OFFICE U/G \$ 307.00
- MS WORKS v3.0 \$ 99.95
- MS VISUAL C++ U/G \$ 115.00
- MS VISUAL C++ Prof U/G \$ 234.00
- Q & A w/Free Print Shop \$ 128.00
- Norton Desktop \$ 119.00
- Disney's Aladdin Print Kit \$ 16.00
- MS Flight Simulator \$ 56.00

## MISCELLANEOUS

- US Robotics 14.4 Fax / Modem Int. \$ 227.00
- Logitech MOUSEMAN 75.00
- Logitech SCANMAN 32F 153.00
- MS Mouse II 85.00
- GRVIS Gamepad 20.00

## PRINTERS

- CANON BJ-200 ~~CALL~~
- CANON BJC-600 ~~775.00~~
- RAVEN 2405 250.00
- SPACE SAVER KIT 16.55



**Markham**  
825 Denison St. Unit 4  
Ont. L3R 5E4  
Tel: (905) 946-9440  
Fax: (905) 946-1098

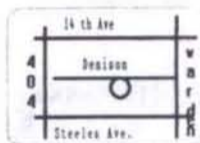

Corporate Orders welcome; Computer Upgrade; Hardware, Networking; CAD Station Markham.....North York.....Hong Kong

### 1. ACC -- Pro VESA Local Bus System w/128K cache

VESA 486DX-33/40  
**\$ 1570**

VESA 486DX2-66  
**\$ 1840**

#### Menu

- \* 4 MB RAM (70 nsec. Exp. to 128MB)
- \* 1.44 MB Floppy Drive (Japanese)
- \* 245 MB IDE Hard Drive
- \* IDE Controller, 2S/1P/1G
- \* 14" SVGA N.I. Monitor 0.28 d.p.
- \* Local Bus SVAG display w/ 1MB
- \* Mini Tower Case w/ 220W CSA
- \* 101 Enhanced Keyboard
- \* 3 buttons Mouse and pad
- \* Power Bar, box of diskette

#### Upgrades:

- Local bus IDE \$30
- 256K Cache \$30
- 1.2MB Floppy \$60
- Med tower case \$40
- 15" FST1280 monitor \$180
- Hard drive to 345MB \$90

### 2. ACC Basic System w/128K cache

AMD386DX-40  
**\$ 1120**

1486 SX-25  
**\$ 1200**

1486 SX-33  
**\$ 1250**

#### Menu

- \* 4MB RAM (70nsec Exp. to 128 MB)
- \* 1.44MB Floppy Drive (Japanese)
- \* 130MB IDE Hard Drive
- \* IDE Controller, 2S/1P/1G
- \* SVGA display w/ 512 KB
- \* 14" SVGA Monitor 0.28
- \* Mini tower Case
- \* 101 enhanced Keyboard
- \* 3 buttons mouse and pad
- \* Power bar, box of diskette

#### Upgrades:

- Local bus 486 mainboard \$20
- 1.2mb floppy \$60
- SVGA to 1MB \$30
- Hard drive to 245MB \$80
- 0.28 N.I. Monitor \$30

### Multimedia \$599. CREATIVE DISCOVERY CD 16 KIT

- |                                       |                                  |                             |
|---------------------------------------|----------------------------------|-----------------------------|
| Mitsumi CD ROM (1X) \$195             | Sound Blaster Pro \$160          | Including:                  |
| Mitsumi FX CD ROM (2X) \$280          | Sound Blaster 16MCD \$239        | Panasonic 562-B CD ROM      |
| Panasonic 562 CD ROM (2X) \$280       | ATI VGASTEREO-FX \$160           | Sound Blaster 16 card       |
| NEC CD ROM (3X) \$800                 | Soltrix SB Comp. sound card \$65 | 1 pair of speaker           |
| Venturer Ext. CD ROM w/ 3 title \$270 | Speakers from \$10               | 3 CD titles w/ Encyclopedia |

### MONITOR

- 14" SVGA 0.39 \$270
- 14" SVGA 0.28, 1024 \$320
- 14" SVGA 0.28, 1024, N.I. \$350
- 14" SVGA 0.28, 1280 N.I. \$380
- 15" SVGA 0.28, 1280 FST \$530

### FAX/ Modem

- Soltrix 96/24, Int. \$65
- PC Logic 96/24, Int. \$75
- US Robotic 14.4, Int. \$210
- Intel 14.4, Int. \$220
- Int. 14.4, Ext. \$250

### PRINTERS

- Raven #2405 \$255
- Raven #2406 Col. \$275
- Color Kit for #2406 \$55
- Canon BJ200 \$370
- Canon BJ600C \$780

\* All systems 48 hours burn-in test, 2 years Labour and 1 year Parts Warranty  
\* Prices are cash discounted and subject to change without notice

# ONWARD COMPUTER

**Store Hours:**  
Mon - Wed, Fri 9:30 - 6:00  
Thur 9:30 - 8:00  
Sat 10:00 - 5:00

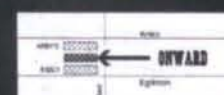

5070 Dixie Road (N of Eglinton), Mississauga  
Tel.: (905) 602-5070 Fax: (905) 238-3312

Computers Computers Computers Computers Computers

## \$ INCREDIBLE SAVINGS \$ IBM VALUEPOINT 486 DX-33

### Features:

- 486DX 33 MHz Intel CPU
- 4 MB RAM
- 120 MB IDE Hard Drive
- 1.44 MB Floppy Drive
- 1 MB VESA Bus Video Adaptor
- .28 DP 14" SVGA Monitor\*
- Mouse & Keyboard
- Preloaded with PC DOS & Windows
- 3 Year Warranty (1st year on-site, 2nd & 3rd depot)



**\$1,999.99**

\* Megalimage/Dayter .28 SVGA Monitor

## MULTIMEDIA READY-TO-RUN COMPLETE SYSTEM

- IBM 486SLC2-66 VESA Bus
- 4 MB RAM
- 125 MB Hard Drive
- VESA Bus IDE I/O (2 S/1 P/1 G)
- 1.44 MB Mitsubishi Floppy Drive
- SVGA Monitor & 512K Card
- Mouse & Keyboard
- Preloaded with MS DOS 6.0 & Windows 3.1
- Sony CD-ROM, Sound Card & Speakers w/ Choice of Any 3 CD Titles  
Mother Goose, Compton's Encyclopedia, Kings Quest V, Wing Commander, Chessmaster 3000

**\$1,669.99**

## MULTIMEDIA UPGRADES

- |                        |          |                              |          |
|------------------------|----------|------------------------------|----------|
| • Sony CD ROM          | \$219.99 | • Mitsumi CD ROM             | \$199.99 |
| • SoundTrek w/speakers | \$59.99  | • Misumi CD ROM Double Speed | \$269.99 |
| • Sound Blaster 16     | \$169.99 | • PC Logic 16 Bit Sound Card | \$149.99 |
- CD Titles**
- |  |         |                          |         |
|--|---------|--------------------------|---------|
| • Compton's Encyclopedia (Interactive) | \$89.50 | • Mother Goose           | \$25.50 |
| • Microsoft Bookshelf/93               | \$65.50 | • Kings Quest V          | \$25.50 |
| • Dinosaur Adventure                   | \$25.50 | • Wing Commander         | \$20.00 |
| • Animals                              | \$25.50 | • Chessmaster 3000       | \$20.00 |
| • Family Doctor                        | \$25.50 | • Compton's Encyclopedia | \$39.50 |
| • Carmen Sandiego                      | \$31.50 | • MacMillan Dictionary   | \$31.50 |
| • World Atlas (Deluxe Pack)            | \$35.50 | • Languages of the World | \$31.50 |

## BEST BUY OF THE MONTH



**Notebook \$2449.99**

486SX-25, 4MB RAM  
120 MB Hard Drive, DOS & Windows  
Fax/Modem & WinFax, Trackball

\* TV to Notebook Computer Box **\$269.00**

**CASH AND CARRY - WHILE STOCK LASTS**

## 3A COMPUTERS

250 SHEPPARD AVE. EAST (AT WILLOWDALE, EAST OF YONGE STREET)  
NORTH YORK, ONTARIO

**LEASING AVAILABLE**

**TEL: (416) 250-5775**

All trade marks are the properties of their respective owners

Computers Computers Computers Computers Computers

# MacWorld The QuickTour

BY DOUGLAS ALDER

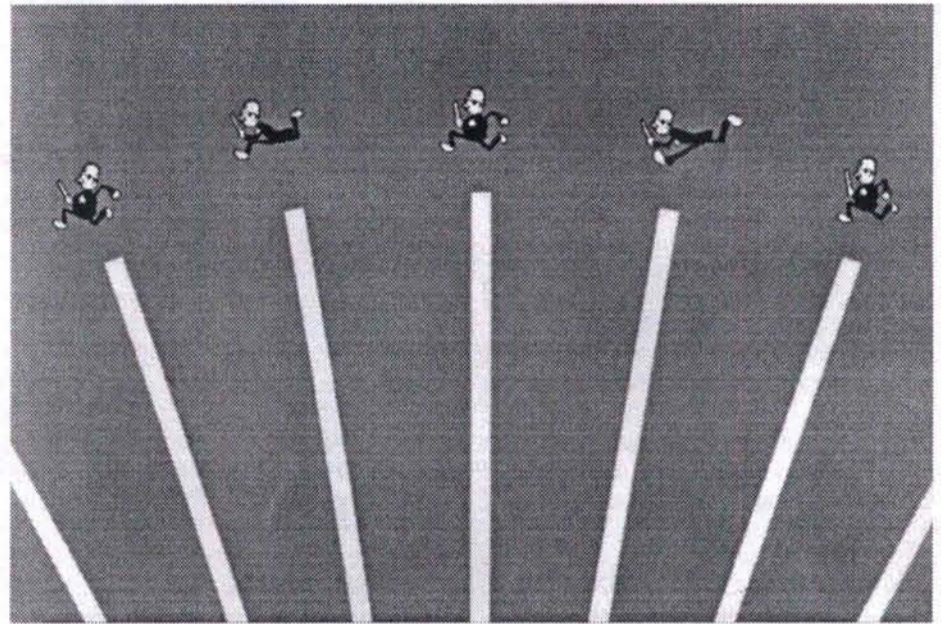

The *Do-We-Really-Need-This Award* had to go to S.H. Pierce and Co, the makers of Poster-Works. It was on hand to show off its latest product, a program that allows you to create and print FlipBooks.

Remember those old Red Ryder books

from the 1930s and '40s? If you held them the right way and flipped the corners of the book, you would see an animated person running or tripping on something.

Contact: S.H. Pierce and Co. 617-338-2222

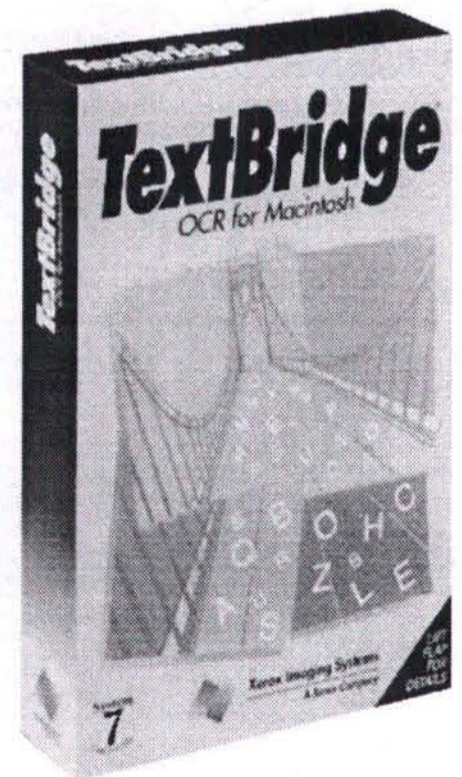
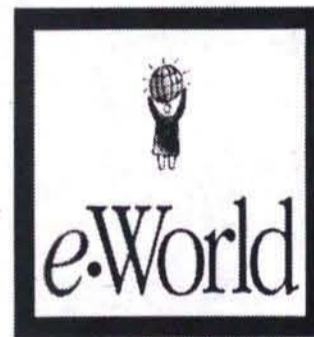

Although it is still under construction, Apple Computer was showing its recently announced e•World telecommunications service. Similar to America Online, or CompuServe, the system features a small town metaphor to guide users through the system.

Contact Apple Computers 416-444-2531.

Xerox introduced TextBridge, son of AccuPage, their Optical Character Recognition package. The big news was the price — US\$79. They are pricing it like a utility, rather than an application package, much to the consternation of competitors like Caere, whose competing product sells for \$250-\$900.

Contact: Xerox Imaging Systems 508-977-2000.



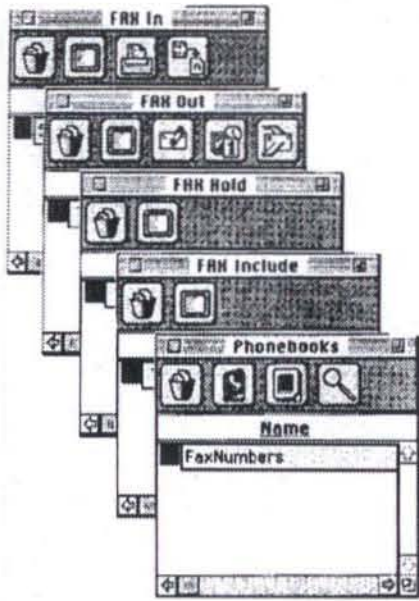

their Cascade CD100 Jukebox. This cool unit puts 100 CDs in a storage housing and can move you between CDs in 8 seconds from spin up to spin down. In the display, they had put up a bunch of CD-ROMs full of clip art, and had thrown it at Aldus Fetch. Fetch catalogued the clip art into thumbnails, with appropriate comments and descriptions beside the images.

The user would then open Fetch, type a description of what they were looking for. Fetch searches its indexes and comes up with a short list of images that meet the criteria. The user then reviews the images, double-

clicks the one they like and presto, the CD jukeboxes loads the right disk and 8-15 seconds later, you have the selected image. Wonderful stuff, and cheap too, a mere \$9,995.

Contact: Pinnacle Micro 714-727-3000.

Plain paper imagesetters abounded at the show. NewGen, Data Products, GCC, LaserMaster, Apple and QMS all were on hand with large format (11"x17" paper, often with full bleed capabilities) were all competing with 800-1200 dpi models.

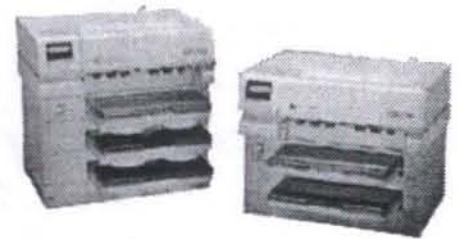

Contact: NewGen 714-641-8600, Dataproducts 818-887-8365, GCC 1-800-263-1405, QMS 416-673-8060, Apple 416-444-2531.

STF Technologies was on hand touting their new version of FaxSTF 3.0. The product now boasts grey scale capabilities and the ability to merge two faxes into one, in answer to recently announced competition from Delrina's FaxPro for Macintosh.

Previous to the Delrina product announcement, FaxSTF had very little competition in the Macintosh fax upgrade marketplace. The Pro version of FaxSTF, although not yet shipping will feature OCR and AOCE PowerTalk support.

Contact: STF Technologies 816-463-2021



If I get one of these, I can open my own burger palace. Pinnacle Micro, a stylish vendor of high end storage devices was showing

# SIRUS

The Pursuit of Excellence.

### SERIES 2100 BUSINESS PRO

- Genuine INTEL 32-bit Microprocessor
- VESA Local Bus Main Board
- 128K External Cache
- AMI BIOS
- 4 Meg RAM - 70 ns
- QUANTUM/CONNER 170 Meg IDE Hard Drive
- PANASONIC 1.44 Meg Floppy Drive
- Professional Mini Tower Chassis
- MOREX 200W CSA Level-3 Power Supply
- 32-bit VESA T-9400 Graphics Accelerator w/ 1 Meg
- MITSUMI Enhanced 101Keyboard
- 14" Non-interlaced Ultra VGA Monitor .28 dp Supports Ultra High Resolution of 1024 x 768
- IDE HDD / FDD Controller
- 2 x Serial / 1 x Parallel / 1 x Game Port
- Z-NIX Serial Mouse
- 1 Year Parts & 2 Year Labour Depot Warranty

|                                      |                                       |
|--------------------------------------|---------------------------------------|
| <b>i 486SX-25</b><br>SKU # 210-4525T | <b>i 486SX-33</b><br>SKU # 210-4533T  |
| <b>\$1,300</b>                       | <b>\$1,345</b>                        |
| <b>i 486DX-33</b><br>SKU # 210-4033T | <b>i 486DX2-66</b><br>SKU # 210-4166T |
| <b>\$1,540</b>                       | <b>\$1,815</b>                        |

### SERIES 3100 REFERENCE STANDARD

- Genuine INTEL 32-bit Microprocessor
- VESA Local Bus Main Board
- 128K External Cache
- AMI BIOS
- 4 Meg RAM - 70 ns
- QUANTUM 270 Meg IDE Hard Drive
- PANASONIC 1.44 Meg Floppy Drive
- Professional Mini Tower Chassis
- MOREX 200W CSA Level-3 Power Supply
- 32-bit VESA CL-5428 Graphics Accelerator w/ 1 Meg
- MITSUMI Enhanced 101Keyboard
- 15" PANASONIC (OEM) Non-interlaced Monitor Supports Ultra High Resolution of 1280 x 1024 Complies with Swedish MPR-II Low Radiation Standard
- 32-bit VESA IDE HDD / FDD Controller
- 2 x Serial / 1 x Parallel / 1 x Game Port
- Z-NIX Serial Mouse
- 1 Year Parts & 2 Year Labour Depot Warranty

|                                      |                                       |
|--------------------------------------|---------------------------------------|
| <b>i 486SX-33</b><br>SKU # 310-4533T | <b>i 486DX-33</b><br>SKU # 310-4033T  |
| <b>\$1,735</b>                       | <b>\$1,930</b>                        |
| <b>i 486DX-50</b><br>SKU # 310-4050T | <b>i 486DX2-66</b><br>SKU # 310-4166T |
| <b>\$2,180</b>                       | <b>\$2,210</b>                        |

### SERIES 5100 TOWER OF POWER

- Genuine INTEL 32-bit Microprocessor
- VESA Local Bus Main Board
- 256K External Cache / 3 x VESA Slots
- INTEL OverDrive ZIF Socket 3
- Upgradable to PENTIUM Technology
- AMI BIOS
- 8 Meg RAM - 70 ns (Max. 112 Meg on Board)
- QUANTUM/CONNER 340 Meg IDE Hard Drive
- PANASONIC 1.2 & 1.44 Meg Floppy Drives
- KINGSPAD Professional Full Tower Chassis
- KINGSPAD 300W CSA Level-3 Power Supply
- DIAMOND VIPER Graphics Accelerator w/ 2 Meg VRAM
- MAXISWITCH Programmable 124-key Keyboard
- 17" PANASONIC (OEM) Non-interlaced Monitor Supports Ultra High Resolution of 1280 x 1024 Complies with Swedish MPR-II Low Radiation Standard
- 32-bit VESA IDE HDD / FDD Controller
- 2 x Serial / 1 x Parallel / 1 x Game Port
- MICROSOFT Serial Mouse II with v. 9.01 Driver Disk
- MICROSOFT DOS 6.2 Installed with Manual
- 2 Year Parts & Labour Warranty

|                                      |                                       |
|--------------------------------------|---------------------------------------|
| <b>i 486SX-33</b><br>SKU # 510-4533F | <b>i 486DX-33</b><br>SKU # 510-4033F  |
| <b>\$3,450</b>                       | <b>\$3,645</b>                        |
| <b>i 486DX-50</b><br>SKU # 510-4050F | <b>i 486DX2-66</b><br>SKU # 510-4166F |
| <b>\$3,895</b>                       | <b>\$3,925</b>                        |

**REPAIR/UPGRADE SERVICE CENTRE**  
Computer & Printer Repair  
Computer Parts + Installation  
System Upgrade  
Networking

**AT & T MODEL 515 500W Uninterrupted Power Supply**

- Advance Sine Wave Technology
- 500 Watts at Full Load
- Protect your investment against blackouts, power sags and spikes

**\$399<sup>00</sup>**

**EPSON Stylus 300 Inkjet Printer**

- Amazingly sharp, clean output at 300 dpi
- Letter Quality Printing at 110 cps
- 8 built-in typefaces, with 4 scalable fonts
- 100-sheet capacity paper tray
- 24K input buffer
- Whisper quiet at 45 dB (A)

**\$319<sup>00</sup>**

**MULTIMEDIA UPGRADE with Microsoft Bookshelf**

- PANASONIC CR-562B Dual Speed Internal CD-ROM Drive, MPC Level 2 Compliance, KODAK Photo Multi-Session
- SoundBlaster 16 ASP Sound Card
- Magnetic Shielded Stereo Speakers
- Microsoft Bookshelf
- Installation included

**\$549<sup>00</sup>**

**U.S. MADE 14.4 FAXMODEM**

- High-speed 16550 UART
- ROCKWELL Chip
- 14.4 with Extended MNP 5 and V.42 bis Command Set
- Free CompuServe/Dow Jones/Genie Membership
- Free WINFAX Lite/DOSFAX/COMIT Communication Software

**\$189<sup>00</sup>**

All prices are cash discounted. • Prices exclude freight to locations outside Metropolitan Toronto. Advertised Sales are final. • Prices & specifications are subject to change without prior notice. • E. & O.E.

**Macintosh, Windows, OS/2, UNIX**

Confused by all the computer jargon? Don't know the right system for you? We offer:

- Plain English recommendations
- Advice based on your needs—not on brand affiliation.

Specialists in:

- Databases
- Accounting Software
- Spreadsheets
- Word Processing Software
- Networking

Call today for a free first consultation.

**DINAMIS CORPORATION**  
**905-474-0890**

|   |  |  |  |  |
|---|--|--|--|--|
| <p><b>849-3868</b></p> <p><b>ARK SYSTEM SOLUTIONS</b><br/>207 Church Street<br/>(Dunn / Church)<br/>FAX: (905) 845-0411</p> | <p><b>459-2899</b></p> <p><b>MICRO ELECTRONIQUE</b><br/>Shoppers World, Shop 95<br/>(Hwy 10 / Steeles)<br/>FAX: (905) 459-8733</p> | <p><b>738-0744</b></p> <p><b>ALPHA COMPUTER CONNECTION</b><br/>2050 Steeles Ave., W. Unit 2<br/>(Keele / Steeles W.)<br/>FAX: (905) 738-1570</p> | <p><b>297-7656</b></p> <p><b>ALPHA COMPUTER CONNECTION</b><br/>3030 Midland Ave., Unit 5<br/>(Midland / Finch)<br/>FAX: (416) 297-9778</p> | <p><b>470-2412</b></p> <p><b>SIRUS TECH INC.</b><br/>250 Cochrane Dr., Unit 9<br/>(Woodbine / Hwy 7)<br/>FAX: (905) 470-1873</p> |
|---|--|--|--|--|

TC/CP40201

The best computer desk I have seen yet was on display from a company called **Winners Only**. It was a light colored, solid oak corner desk. Everything was built-in. You could hide a printer in the bottom drawer, or a notebook on the top drawer. There was a monitor support arm and wiring hideaways. Very nice, not cheap though. US\$1,600 plus about \$300 to ship to Canada.



Contact: 1-800-337-5382

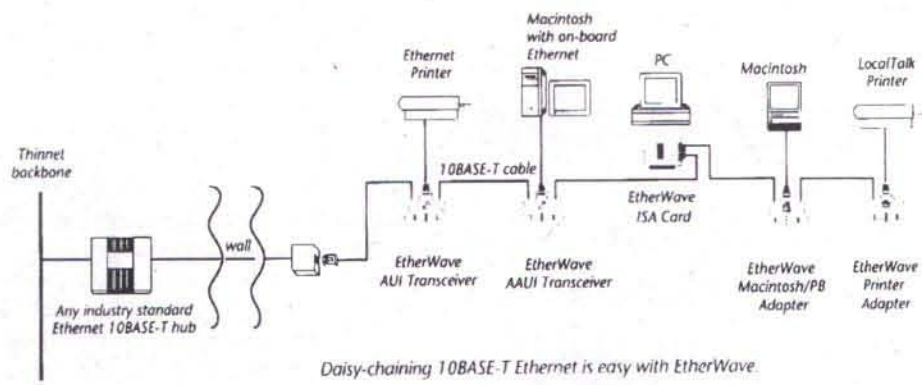

| SELECTED SYSTEMS   | 486DLC-40<br>w.128KB cache | 486DX-33<br>w.256KB cache             | 486DX2-50<br>w.256KB cache            | 486DX2-66<br>w.256KB cache            | PENTIUM 60<br>w.256KB cache      |
|--|----------------------------|---------------------------------------|---------------------------------------|---------------------------------------|----------------------------------|
| BUS  | ISA                        | 3 VESA LBus slots<br>+ Pentium socket | 3 VESA LBus slots<br>+ Pentium socket | 3 VESA LBus slots<br>+ Pentium socket | 3 PCI LBus slots<br>+5 ISA slots |
| MEMORY   | 4MB, max 32MB              | 4MB, max 32MB                         | 4MB, max 32MB                         | 4MB, max 32MB                         | 8MB, max 192MB                   |
| IDE HARD DRIVE   | 160MB w cache              | 245MB with cache                      | 245MB with cache                      | 245MB with cache                      | 340MB with cache                 |
| N.I. 14" SVGA<br>MONITOR 0.28  | \$1279                     | \$1689                                | \$1759                                | \$1959                                | \$4180                           |
| All systems come with: 1MB SVGA video card, 101 enhanced keyboard, 1.2MB 5.25" & 1.44MB 3.5" floppy disk drives, mini tower case, 200W power supply, 2 serial, 1 parallel, 1 game port, mouse, clock, calendar, CMOS backup battery, AMI Bios. |                            |                                       |                                       |                                       |                                  |

# Rent

## Computers

Notebooks and 486, 386, 286 systems with the monitor and hard drive capacity of your choice.

## Printers

Dot-matrix printers and excellent Laser printers for top quality documents.

**Systems upgrade: XT, 286, 386-->386, 486. Memory and Hard drives upgrade. Local Area Network Installations, Programming, Repairs**

# Compu memories

(416) 232 2777

Better Business Bureau Member

3088 Bloor Street West  
Toronto, Ontario, M8X 1C8  
Two blocks west of Royal York Rd.

|   |  |  |  |
|---|--|--|--|
| <b>MOTHERBOARDS (AMI BIOS)</b><br>486DX2-66 EISA+VL Bus, 256KB...1095<br>486DX2-66, 256KB cache, VL Bus...795<br>486DX2-50, 256KB cache, VL Bus...595<br>486DX-40, 256KB cache, VL Bus...515<br>486DX-33, 256KB cache, VL Bus...505<br>486DLC-40 Texas In 128KB cache...199<br>386DX40, 128KB cache...189<br>386SX40...99   | 340MB (13ms/64KB cache)...385<br>510MB (12ms/128KB cache)...695  | <b>CITIZEN</b><br>GSX-230 24pin/color option...329<br>GSX-240 24pin/color option...385<br><b>EPSON</b><br>LQ-570 24pin...345   | Procomm Plus for Windows...129<br>PC TOOLS Dos or Windows ver...110<br>Harvard Graphics upgrade...109<br>CadKey Light...185<br>Quicken Canadian Win or DOS...59<br>CA Simply Accounting Win...130<br>Fastback Dos or Windows...112<br>Lantastic V 5.0...119<br>CD Encyc. BRITANICA (Dos)...35<br>CD Family Doctor (MPC)...38<br>CD Webster Dictionary (Win)...34<br>CD Mayo Health Clinic (Dos)...35   |
| <b>TAPE BACKUPS</b><br>Conner 250MB internal...245<br>Conner 250MB external (parallel)...475<br>Colorado 250MB internal...245<br>Colorado 250MB Trakker ext...465   | <b>CD ROMS</b><br>NEC CDR-74 280ms external...585<br>NEC CDR-84 280ms internal...620<br>NEC CDR500 3Xi Internal...750<br>NEC CDR600 3XE External...755<br>TEXEL 270ms internal SCSI...535<br>Toshiba 3401 internal SCSI...520<br>Philips 206 internal...295<br>Panasonic 562...295<br>SONY 31A internal...209<br>MITSUMI internal...212  | <b>INK JET</b><br><b>HEWLETT PACKARD</b><br>HP DESK JET 500...449<br>HP DESK JET 500C...585<br>HP DESK JET 550C...845<br><b>CANON</b><br>CANON BJ10ex...299<br>CANON BJ200...385<br>CANON BJ230...525<br>CANON BJ600...785<br><b>FARGO ELECTRONIC</b><br>FARGO Primera color printer...995   | <b>FAX &amp; MODEM</b><br>PCMCIA ATI 14400 FAX/MODEM...425<br>ZOLTRIX 9600/2400 F/M internal...89<br>ZOLTRIX 14.4 F/M internal...175<br>ZOLTRIX 14.4 F/M external...225<br>BOCA 14.4 F/M internal...175<br>US ROBOTICS 14.4 F/M internal...205<br>US ROBOTICS 14.4 F/M external...235<br>ATI 14.4 ETC-I F/M internal...205<br>ATI 14.4 ETC-E F/M external...245<br>Zoom Pocket 96/24 Fax/Modem...125<br>INTEL SatisFAXtion 400 internal...379<br>INTEL SatisFAXtion 400e external...425<br>Auto Voice/Data switch f.modem...145<br>Fax/Phone/Modem auto switch...139<br>Ident-A-Call switch...125  |
| <b>VIDEO CARDS</b><br>ATI XL 24bit Color 1MB w./mouse...165<br>ATI XL 24bit Color 1MB...145<br>ATI WONDER GT 1MB OEM...225<br>ATI ULTRA 1MB OEM...225<br>ATI ULTRA PLUS 2MB OEM...285<br>ATI ULTRA PRO 2MB OEM...419<br>ATI ULTRA Vesa LBus 2MB OEM...380<br>ATI ULTRA PRO EISA 2MB OEM...469<br>CIRRUS LOGIC 1MB VESA LBus...145<br>TRIDENT 1MB VESA LBus...125  | <b>MULTIMEDIA</b><br>Texel & Pro Audio Spectrum 16...695<br>Sony & PC Logic sound card...555<br>ATI Sound Dimension Stereo FX...439  | <b>NOTEBOOKS</b><br>BONDWELL 486DLC33 4/80...1680<br>RAVEN Flite 4 486SLC 4/170MB...2550<br>AST Bravo 486SX25 4MB/80MB...2245<br>AST Bravo 486SX25 4MB/120MB...2445<br>AST Bravo 486SX25 4MB/170MB...2695<br><b>TOSHIBA</b><br>T-1900 486 SX25 4MB/120MB...2545<br>T-1900C 486 SX25 4MB/200MB...3990   | <b>AUDIO CARDS</b><br>LOGITECH Soundman 16...210<br>Cardinal 16 bit sound card...190<br>Cardinal 16 bit sound card SCSI...230<br>Sound Galaxy NX Pro 16...199<br>Sound Blaster ASP 16 CD...285<br>Sound Blaster Pro DeLux...155<br>Sound Blaster 16...175  |
| <b>HD CONTROLLERS</b><br>IDE VESA Local Bus HDD/FDD...49<br>IDE VESA LBus HDD/FDD 16550...109<br>Adaptec 1522A SCSI HDD/FDD...119   | <b>MONITORS</b><br>TTX SVGA n.i. 0.28...355<br>TTX SVGA n.i. 0.28 15"...515<br>ORCHESTRA SVGA n.i. 0.28...355<br>DC-521 SVGA DataTrain 0.28...325<br>NEC 3FGE SVGA...799<br>NEC 4FGE SVGA...949<br>NEC 5FGE SVGA...1850  | <b>PCMCIA CARDS</b><br>PCMCIA ATI 14400 FAX/MODEM...425  | <b>MEMORY UPGRADE &amp;...</b><br>Memory for IBM PS/1, PS/2, Dell Packard Bell, Notebooks...CALL<br>HP4 4MB...259<br>4MB SIMM module 70ns...195<br>HP IIP/IIIP/III 1/2/4MB...99/155/285<br>OKI 400 1MB/2MB...109/165<br>PostScript for HP 4...415<br>387DX MathCo-all speeds...75<br>Microtek ScanMaker II...1195<br>Logitech ScanMan 256/color...274/540<br>SummaSketch 12X12 16 Buttons...495<br>Selection of Cables & Switch boxes  |
| <b>HARD DRIVES</b><br><b>WESTERN DIGITAL</b><br>212MB (13ms/64KB cache)...285<br>256MB (13ms/64KB cache)...315<br>340MB (13ms/128KB cache)...385<br>425MB (13ms/128KB cache)...495<br>540MB (13ms/128KB cache)...680<br><b>QUANTUM</b><br>170MB (9ms/32KB cache)...275<br>245MB (9ms/256KB cache)...315<br>270MB (12ms/128KB cache)...339<br>340MB (12ms/128KB cache)...385<br>540MB (12ms/128KB cache)...680<br><b>MAXTOR</b><br>245MB (14ms/64KB cache)...315<br>345MB (14ms/64KB cache)...385<br><b>FUJITSU</b><br>520MB (12ms/256KB c.) IDE/SCSI...720<br><b>SEAGATE</b><br>260MB 3298A (16ms/64KB cache)...315<br>340MB 3390A (12ms/256KB c.)...405<br>450MB 3550A (12ms/256KB c.)...535<br><b>CONNER</b><br>245MB (13ms/64KB cache)...315 | <b>SOFTWARE</b><br>DOS 6.2 step up upgrade...15<br>MS DOS 6.2 full version...69<br>WINDOWS 3.1 full version...65<br>Windows for Workgroups 3.11 upgr...59<br>WINDOWS NT...365<br>Microsoft ENCARTA CD 1994...115<br>OS/2 Ver 2.1 upgrade...112<br>OS/2 for Windows...67<br>MS WORD 6.0 Win upgrade...145<br>MS WORKS DOS or Windows ver...75<br>MS OFFICE 4.0 upgrade...325<br>MS EXCEL Win upgrade...155<br>PARADOX 2.0 Win...159<br>Lotus 1-2-3 Win upgrade...119<br>Lotus AMI PRO full ver...170<br>Lotus Improv v. 2.1 comp. upgr...175<br>Quattro Pro Ver 5.0 Win upgrade...69<br>Word Perfect 6.0 Dos or Win upgr...139<br>WinFax Pro Win...100<br>Delrina Perform Pro...225 | <b>SOFTWARE</b><br>DOS 6.2 step up upgrade...15<br>MS DOS 6.2 full version...69<br>WINDOWS 3.1 full version...65<br>Windows for Workgroups 3.11 upgr...59<br>WINDOWS NT...365<br>Microsoft ENCARTA CD 1994...115<br>OS/2 Ver 2.1 upgrade...112<br>OS/2 for Windows...67<br>MS WORD 6.0 Win upgrade...145<br>MS WORKS DOS or Windows ver...75<br>MS OFFICE 4.0 upgrade...325<br>MS EXCEL Win upgrade...155<br>PARADOX 2.0 Win...159<br>Lotus 1-2-3 Win upgrade...119<br>Lotus AMI PRO full ver...170<br>Lotus Improv v. 2.1 comp. upgr...175<br>Quattro Pro Ver 5.0 Win upgrade...69<br>Word Perfect 6.0 Dos or Win upgr...139<br>WinFax Pro Win...100<br>Delrina Perform Pro...225 | <b>SOFTWARE</b><br>DOS 6.2 step up upgrade...15<br>MS DOS 6.2 full version...69<br>WINDOWS 3.1 full version...65<br>Windows for Workgroups 3.11 upgr...59<br>WINDOWS NT...365<br>Microsoft ENCARTA CD 1994...115<br>OS/2 Ver 2.1 upgrade...112<br>OS/2 for Windows...67<br>MS WORD 6.0 Win upgrade...145<br>MS WORKS DOS or Windows ver...75<br>MS OFFICE 4.0 upgrade...325<br>MS EXCEL Win upgrade...155<br>PARADOX 2.0 Win...159<br>Lotus 1-2-3 Win upgrade...119<br>Lotus AMI PRO full ver...170<br>Lotus Improv v. 2.1 comp. upgr...175<br>Quattro Pro Ver 5.0 Win upgrade...69<br>Word Perfect 6.0 Dos or Win upgr...139<br>WinFax Pro Win...100<br>Delrina Perform Pro...225 |
| <b>LASER PRINTERS</b><br><b>HEWLETT PACKARD</b><br>HP 4L...989<br>HP 4ML...1425<br>HP 4...1950<br><b>RAVEN</b><br>RAVEN LP510...720<br>RAVEN LP530...930<br><b>OKI</b><br>OKI DATA 400e...685   | <b>DOT MATRIX</b><br><b>PANASONIC</b><br>KX-P2023 24pin...265<br>KX-P2123 24pin /color option...295<br><b>RAVEN</b><br>RP-2405 24pin...255<br>RP-2406 24pin /color option...295<br>PR-2465 24pin wide carriage...465   | <b>SOFTWARE</b><br>DOS 6.2 step up upgrade...15<br>MS DOS 6.2 full version...69<br>WINDOWS 3.1 full version...65<br>Windows for Workgroups 3.11 upgr...59<br>WINDOWS NT...365<br>Microsoft ENCARTA CD 1994...115<br>OS/2 Ver 2.1 upgrade...112<br>OS/2 for Windows...67<br>MS WORD 6.0 Win upgrade...145<br>MS WORKS DOS or Windows ver...75<br>MS OFFICE 4.0 upgrade...325<br>MS EXCEL Win upgrade...155<br>PARADOX 2.0 Win...159<br>Lotus 1-2-3 Win upgrade...119<br>Lotus AMI PRO full ver...170<br>Lotus Improv v. 2.1 comp. upgr...175<br>Quattro Pro Ver 5.0 Win upgrade...69<br>Word Perfect 6.0 Dos or Win upgr...139<br>WinFax Pro Win...100<br>Delrina Perform Pro...225 | <b>SOFTWARE</b><br>DOS 6.2 step up upgrade...15<br>MS DOS 6.2 full version...69<br>WINDOWS 3.1 full version...65<br>Windows for Workgroups 3.11 upgr...59<br>WINDOWS NT...365<br>Microsoft ENCARTA CD 1994...115<br>OS/2 Ver 2.1 upgrade...112<br>OS/2 for Windows...67<br>MS WORD 6.0 Win upgrade...145<br>MS WORKS DOS or Windows ver...75<br>MS OFFICE 4.0 upgrade...325<br>MS EXCEL Win upgrade...155<br>PARADOX 2.0 Win...159<br>Lotus 1-2-3 Win upgrade...119<br>Lotus AMI PRO full ver...170<br>Lotus Improv v. 2.1 comp. upgr...175<br>Quattro Pro Ver 5.0 Win upgrade...69<br>Word Perfect 6.0 Dos or Win upgr...139<br>WinFax Pro Win...100<br>Delrina Perform Pro...225 |

Farallon, long time manufacturer of networking products for the Mac, has come out with a way to daisy-chain ethernet using 10baseT cables.

Up to now, this was possible with coaxial cable (the kind of wire that your cable TV company uses), but not with 10baseT wire (which looks like diet-challenged telephone wire). Previously you had to create star configurations coming from a Hub, which added to the expense. These connectors are priced competitively with other Ethernet cards.

Contact: Farallon 510-814-5100.

## WOMEN'S WIRE

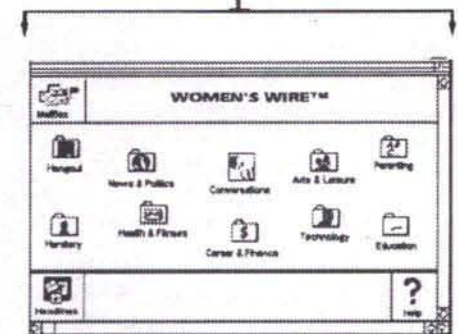

WIRE is an interesting FirstClass-based electronic BBS dedicated to women's issues.

Nice graphics and a user-friendly interface combined with discussions and files relevant to women. Subscription is \$15 a month, which includes two hours of access time. Additional time is \$2.50 an hour, plus access. They are working on getting it accessible in Canada for better rates as well.

Contact: Women's Wire 415-615-8989.

## SIGHTINGS / Steven M. Johnson

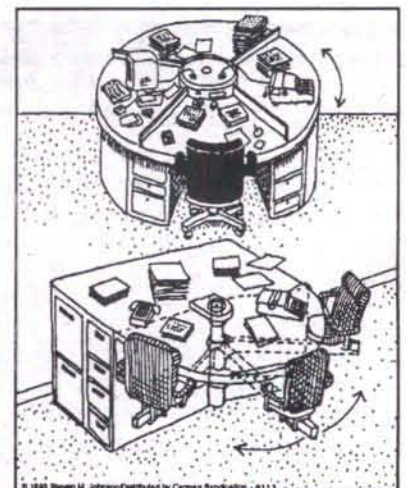

Desks made by Lazy Susan Industries of Iowa and designed for busy managers, office workers and writers who need to jump from job to job.

# Connectix Doubles RAM

(NB) — Connectix has released RAM Doubler, a utility, the company claims, will double the memory of Macintosh computers with 4 megabytes (MB) or more of RAM.

Working as a system extension, RAM Doubler is dropped into the System Folder and works in the background invisible to the user. Connectix claims its new set of memory protocols can typically triple the amount of information stored in a MB of RAM. System 6 or higher and a Mac II or better are required.

Debbie Degutis explained to Newsbytes that the RAM Doubler does not affect the first two MB of RAM and that the technology could not be released while the patent is pending. The program does not make programs run faster, but will allow more windows to be open.

Connectix also produce Connectix PowerBook Utilities, Desktop Utilities, Virtual, MAXIMA, and MODE32. It is located in San Mateo, California. ■

Contact: 415-571-5100 or 800-950-5880.

# Apple Video Goes On The Road

SAN FRANCISCO (NB) — Tucked in a corner of Macworld Exposition, behind the Accounting Software Pavilion, Desktop Video World magazine sponsored a special exhibit called "Plug Into the Future of Desktop Video."

The exhibit featured the new Apple Professional Video Production System, as well as products from Radius, Apple New Media, Adobe, VideoFusion and Storage Dimensions.

To assist in the task of educating video producers nationwide about the benefits of desktop video production, the companies showing in the pavilion are sponsoring the tractor-trailer/theater on a trip around the US, and perhaps beyond. ■

Contact: Desktop Video World, 603-924-0100

# Ancient Cities Coming On CD

BY PATRICK MCKENNA

SAN FRANCISCO (NB) — Scientific American and Sumeria announced the development of *Ancient Cities*, an interactive CD-ROM title.

This marks the first venture of *Scientific American*, the oldest continuous running publication in America, into the world of digital imaging.

They have chosen Sumeria, a young multimedia publisher, to form a collaboration for the production of *Ancient Cities*.

Sumeria has previously released its Ocean Life series, QuickTime the CD, Space—A Visual

History, and other titles.

*Ancient Cities* is developed from the book of the same name, which is a collection of articles by leading academics on their research of eighteen ancient cities.

The CD allows users to explore Teotihuacan (Mexico), Pompeii, (Italy), Petra, (Jordan), four of Crete's Bronze Age Palaces, and other well-known sites.

Sumeria uses interactive maps, video, narration, sound, text export, text search, and video

and photo export in the development of this cross-platform CD.

With the extensive libraries and research expertise of *Scientific American*, the collaborators of *Ancient Cities* foresee a source of projects to follow their first release scheduled for early May of 1994. The suggested retail price is US\$59.95. ■

Contact: Sumeria Inc., 415-904-0800; Scientific American, 212-754-0594

## MacWorld Keynote: The Mac Decade

SAN FRANCISCO (NB) — Accompanied by full wall video screens showing charts, video clips and simultaneous video, David Nagel, senior vice president and general manager of AppleSoft division, presented a 10-year review of the Macintosh.

A year-by-year tracking of the developments of the Macintosh compared to the developments of the of the IBM/DOS Platform, drew loud applause from the crowd.

Stating that the aggressive policy of Apple Computer is to produce an affordable and competitive product in a tough economy, develop ease of use, and commit to RISC processing, he outlined the new developments that are currently or soon to be ready for 1994.

The Power PC, PowerShare, open doc framework, Apple Search, Active assistance and speech, and Software Dispatch were each briefly introduced. He stated that Apple's approach to the information superhighway would emphasize usage, customer needs, mobility, and speed as opposed to an emphasis on greater volume and extension of the highway.

A demonstration of the Power PC versus the Pentium and the new Software Dispatch were given a warm reception from the audience of approximately 1,800 attendees. ■

# Analyst Downgrades Apple Despite Successful Macworld

NEW YORK (NB) — The New York stock market organization Oppenheimer & Company downgraded Apple Computer stock from market performer to underperformer, despite Apple's enthusiastically received showing of new products at Macworld and its recent strong stock prices. Analysts at the firm said their biggest fear is Apple could lose profits due to overstocked inventory.

The announcements of new products in the next few months, such as the PowerPC-based Macintosh, as well as the sudden 20 percent jump in Apple stock prices have

Oppenheimer analysts wary.

The firm claims the word on the street is Apple products didn't move as well in the retail channels in December as the company had hoped. The low-end Powerbook notebook models seem to be in ample supply without demand, according to the report, and an overstock there is likely.

While the firm has not downgraded Apple's performance in the long run, it claims conservative money should be wary now with the product transition the company faces. ■



**G.C. SYSTEMS**

TEL. (416) 890-0253 TOR. (416) 219-3683  
FAX. (416) 890-1076

151 BRUNEL RD., UNIT 13, MISSISSAUGA, ONTARIO CANADA L4Z 2H6

## LIMITED TIME OFFER WHILE QUANTITIES LAST!

### Main Board W/CPU

|  |       |
|--|-------|
| 386 SX-40 .....                            | \$92  |
| 386 DX-40W/128 Cache .....                 | \$143 |
| 486 DX-33W/128 Cache VESA Local Bus .....  | \$435 |
| 486 SX-25W/128 Cache VESA Local Bus .....  | \$215 |
| 486 DX-50W/128 Cache VESA Local Bus .....  | \$625 |
| 486 DX2-66W/128 Cache VESA Local Bus ..... | \$694 |

### Hard Drive

|                            |       |
|----------------------------|-------|
| Maxtor 130MB IDE .....     | \$219 |
| Conner 212 MB IDE .....    | \$265 |
| Quantum 270 MB IDE .....   | \$305 |
| WD/Maxtor 340 MB IDE ..... | \$369 |
| WD 420 MB IDE .....        | \$449 |
| WD 540 MB IDE .....        | \$615 |

Please ask for our complete systems 286 to 486

VOLUME DISCOUNTS & FREE DELIVERY ALSO AVAILABLE • PLEASE CONTACT OUR SALES OFFICE FOR DETAILS • PRICES SUBJECT TO CHANGE WITHOUT NOTICE DEALERS ONLY

## • WINTER SPECIALS! •

# 1994 Postal Code Book is Now Available!

~~Computerized Version~~

## "New Release" ZipBASE 2.5 Office for Canada

Contains 3 bilingual mail programs for DOS & WINDOWS to handle every address problem!

1. ZipCode-on-line TSR for address correction and postal code look-up
2. ZipBASE - correct your whole database at once, verifies over 30,00 per hour.
3. ZipReverse-New - type in your postal code and get complete address information.

## The Best Selling Address Utility for Small Business & Homes in Canada

Available at Computer Stores for less than \$66 per user when you purchase the ZipBASE SixPack.

Single User Versions of ZipBASE Office has a suggested Retail Price of \$199.95.

Call Customer Service 1-800-461-1590 for information or a free evaluation of ZipCode for the City of Toronto.

ZipCode is a licensee of the Canada Post Data.





# Throne Computer Systems

Present:

## Winter Special !!

4810 Sheppard Ave. E.,  
Unit 224, Scarborough  
Ont. M1S 4N6

Tel: 609-1668

Mon - Sat 10 am - 6 pm  
Sunday 12 pm - 4 pm

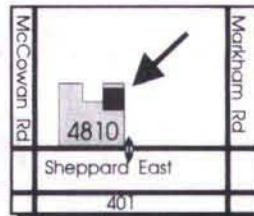

\*\* Leasing option available

### Super VGA Systems

|   |                 |          |
|---|-----------------|----------|
| <b>Package include:</b><br>4 Meg memory, 70ns<br>128K cache on DX & DLC model<br>120M (Actual size) IDE Hard Drive<br>Panasonic 1.44M Floppy Drive<br>Parallel, 2 Serial, Game ports<br>101 enhanced keyboard<br>Mini-Tower with 200W CSA Power Supply<br>512K 16 bits Super VGA Card<br>14" Super VGA color monitor<br>Built-in math co-processor in 486DX model<br>MS compatible 3 button mouse<br>2 years labour & 1 year parts depot warranty | 386-40SX,.....  | \$1029.- |
|   | 386-40DX,.....  | \$1095.- |
|   | 486-40DLC,..... | \$1155.- |
|   | 486-33DX,.....  | \$1405.- |

\*\* Free 75 Meg of Programs \*\*

### Super VGA Multimedia Systems

|   |   |                            |
|---|---|----------------------------|
| <b>MULTIMEDIA 486</b><br>4 Meg 70ns memory, 128K cache<br>250M (Actual size) IDE Hard Drive<br>Panasonic 1.44M Floppy Drive<br>Parallel, 2 Serial, Game ports<br>Keytronic 101 enhanced keyboard<br>1994 style Mini-Tower, 230W Power<br>1 Meg 32 bits Super VGA Card<br>14" 28 Super VGA color monitor<br>Sound Blaster compatible card<br>Built-in math co-processor in 486DX<br>Mitsumi Double Speed 250ms CD ROM<br>Keytronic mouse, Speakers<br>Pentium P24T CPU socket motherboards | <b>Software include:</b><br>75 Meg Programs (see below)<br>MS 6.0, Windows 3.1 with manuals & disks<br>5 CD Disc Titles: 1) Microsoft Bookshelf 93<br>include Encyclopedia, Dictionary, Atlas,<br>World Almanac, Roger's II, Quotations,<br>2) Window MPC Encyclopedia,<br>3) Game Package,<br>4) Megaware<br>5) Selectware | 486SX-33 VESA<br>\$1899.-  |
|   |   | 486DX-33 VESA<br>\$2099.-  |
|   |   | 486DX2-66 VESA<br>\$2369.- |

|                         |                                  |                               |
|-------------------------|----------------------------------|-------------------------------|
| <b>Upgrade Options:</b> | Microphone \$25                  | Medium Tower Case \$40        |
|                         | VESA Trident 1 Meg VGA \$30      | Sound Blaster Pro Deluxe \$99 |
|                         | Panasonic 1.2M Floppy Drive \$63 | Mitsumi Single Speed CD \$70  |
|                         | 15" 28 1280 flat screen \$195    | WD 340M 13ms Hard Drive \$110 |

### Super Special Package !!

**FREE MS DOS 6.0 & Windows 3.1**  
Included Manuals, Disks & Installation

|                 |          |
|-----------------|----------|
| 386-40DX,.....  | \$1409.- |
| 486-40DLC,..... | \$1459.- |
| 486-33SX,.....  | \$1539.- |
| 486-33DX,.....  | \$1719.- |
| 486-66DX2, ...  | \$1999.- |



### Special Package include:

4 Meg 70ns memory, 128K cache  
Intel CPU on 486 SX, DX & DX2 models  
250M (Actual size) IDE Hard Drive  
Panasonic 1.2M & 1.44M Floppy Drives  
Parallel, 2 Serial, Game ports  
Keytronic 101 enhanced keyboard  
1994 style Mini-Tower, 230W CSA Power Supply  
1 Meg 32 bits Super VGA Card  
14" 28 Non-Interlaced Super VGA color monitor  
Keytronic mouse (MS compatible)  
Pentium P24T CPU socket for 486SX,DX,DX2 models  
Built-in math co-processor in all 486DX, DX2 models  
2 years labour & 1 year parts depot warranty

|                         |                                  |       |
|-------------------------|----------------------------------|-------|
| <b>Upgrade Options:</b> | VESA 1 Meg VGA .....             | \$30  |
|                         | VESA 1 M VGA & IDE controller .. | \$50  |
|                         | 15" 28 1280 flat screen.....     | \$175 |
|                         | Less: MS DOS 6.0 .....           | \$40  |
|                         | Less: MS Windows 3.1 .....       | \$40  |

\*\* Free MS DOS 6.0, Windows & 75 Meg of Programs \*\*

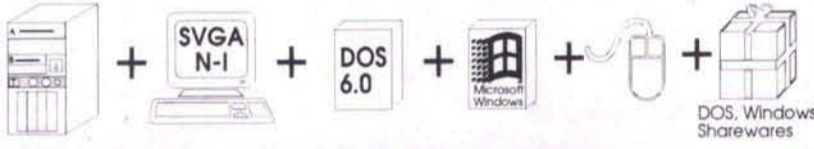

### Free 75 Meg Programs

All Throne Computer Packages come with free 75 Meg programs bundle includes:  
Games, Spreadsheets, Word Processing, Home Organizer, Store phone#, Appointment programs, Educational & Tutorials, Music, Personal and business finance programs, Database, Image Processing, Virus checking & Cleaning, Windows software & Demos, etc.

|  |             |          |
|--|-------------|----------|
|  | HP 4L.....  | \$879.-  |
|  | HP 4ML .... | \$1389.- |
|  | HP 4.....   | \$1875.- |
|  | HP 4MP..... | \$1899.- |

Authorized Retailer

\*\* All special prices on the advertisement are cash discounted, must be pay by cash, money order or certified cheque only. VISA, Master Cards or Government P.O. are on regular prices (Regular price = Cash discounted price + 3%). Government, educational institutions & corporate p.o. are welcome. Prices are subject to change without notice.

### MOTHERBOARDS

|   |        |
|---|--------|
| 386SX-40  | \$ 109 |
| 386DX-40, 128K                                      | \$ 158 |
| 486DLC-40, 128K, mother-board upgradable to DX, DX2 | \$ 229 |
| 486SX-33 128K, 3 VESA                               | \$ 289 |
| 486DX-33 128K, 3 VESA                               | \$ 459 |
| 486DX-50 128K, 3 VESA                               | \$ 668 |
| 486DX2-66 128K, 3 VESA                              | \$ 709 |
| Cooling Fan for 486 CPU                             | \$ 18  |

### CASES with Power Supply

|                               |        |
|-------------------------------|--------|
| Desktop case 200W             | \$ 70  |
| 94" Desktop case 200W         | \$ 80  |
| Mini-Tower case 200W          | \$ 65  |
| 94" Mini-Tower case 230W      | \$ 85  |
| Med-Tower, digital 230W       | \$ 105 |
| Tall Tower case, digital 250W | \$135  |
| 200W power supply             | \$ 45  |
| 230W power supply             | \$ 55  |

### DRIVES & CONTROLLERS

|   |            |
|---|------------|
| IDE Maxtor 245M, 15ms                       | \$ 309     |
| IDE Quantum 170M, 17ms                      | \$ 270     |
| IDE Quantum 525M, 14ms                      | \$ 755     |
| IDE Samsung 125M, 16ms                      | \$ 230     |
| IDE Samsung 251M, 16ms                      | \$ 303     |
| IDE Seagate 340M, 12ms                      | \$ 405     |
| IDE WD 256M, 13ms                           | \$ 315     |
| IDE WD 340M, 13ms                           | \$ 395     |
| IDE WD 420M, 12ms                           | \$ 499     |
| IDE WD 540M, 12ms                           | \$ 675     |
| Conner Int 250M TapeDrive with/without tape | \$ 215/189 |
| Jumbo Int 250M Tape Drive                   | \$ 239     |
| Jumbo Tracker 250M TD                       | \$ 449     |
| Tape DC2120 250M                            | \$ 28      |
| Panasonic 5 1/4" 1.2M                       | \$ 63      |
| Panasonic 3 1/2" 1.44M                      | \$ 55      |
| IDE FD&HD controller                        | \$ 19      |
| VESA IDE FD&HD controller                   | \$ 55      |
| IDE FD&HD 2Ser/1P/1G cntr                   | \$ 30      |
| SCSI Adaptec 1522 for Dos                   | \$ 124     |
| SCSI Adaptec 1542C kit                      | \$ 349     |
| AT I/O card 2Ser/1P/1G ports                | \$ 25      |
| AT MFM HD&FD controller                     | \$ 75      |

### DOT PRINTERS

\*\* 2 years Canadian Warranty \*\*  
Prices are not included color kit

|                                 |        |
|---------------------------------|--------|
| Panasonic 2180, color 9 pins    | \$ 200 |
| Panasonic 2023, 24 pins         | \$ 270 |
| Raven 9105(2180), color 9 p     | \$ 199 |
| Raven 2405(2023), 24 pins       | \$ 249 |
| Raven 2406(2123), color 24 ps   | \$ 275 |
| Raven 2420(2124), color 24 ps   | \$ 389 |
| Raven 2465(1624), 24p wide      | \$ 445 |
| Color Kit(motor, cable, ribbon) | \$ 60  |
| Samsung 2412 24 pins            | \$ 195 |
| Samsung 2421 24 pins Wide       | \$ 380 |

### LASER PRINTER, SCANNER

Canadian warranty, not grey market  
All laser printer come with toner.  
\* Please call to confirm prices.

|                           |         |
|---------------------------|---------|
| HP 4L 4ppm 1M, 300dpi     | \$ 879  |
| HP 4ML 4ppm 4M Postscript | \$1389  |
| HP 4P 4ppm 2M, 600dpi     | \$ 1379 |
| HP 4MP 4ppm 6M, 600dpi    | \$ 1899 |
| HP 4 8ppm 2M, 600dpi      | \$ 1875 |
| HP 4M 8ppm 6M, 600dpi     | \$ 2720 |
| HP ScanJet IIP            | \$ 1030 |
| HP ScanJet IICx, *New     | \$ 1380 |
| Okidata 400e 4ppm 300dpi  | \$ 675  |
| Okidata 410e 4ppm 600dpi  | \$ 915  |
| Okidata DOC'IT 3000 *New  | Call    |
| Okidata DOC'IT 4000 *New  | Call    |
| Raven LP410 4ppm *New     | \$ 699  |
| Raven LP470PS 4ppm        | \$ 1149 |

### INKJET PRINTERS

\*\* 2-3 years Canadian Warranty

|                         |         |
|-------------------------|---------|
| Canon BJ-200            | \$ 379  |
| Canon BJ-600 Color      | \$ 779  |
| Canon BJ-820 Color      | \$ 1399 |
| HP DeskJet 310 portable | \$ 445  |
| Color Kit for HP 310    | \$ 75   |
| HP DeskJet 500          | \$ 405  |
| HP DeskJet 500C color   | \$ 550  |
| HP DeskJet 550C color   | \$ 815  |

Canon, Hewlett Packard, Okidata, Olivetti, Panasonic, Raven, Samsung Authorized

### LASER ACCESSORIES

|  |           |
|--|-----------|
| Canon BJ-xxx Ink Cartridge                       | \$ 32     |
| HP 4L memory 1M (HP)                             | \$ 109    |
| HP 2p,3p,3.3d 1M/2M                              | \$112/179 |
| HP 2p,3p,3.3d 4M                                 | \$ 293    |
| HP 4,4p,4mp,4m memory 4M                         | \$ 225    |
| HP 4,4p,4mp,4m memory 8M                         | \$ 450    |
| HP Toner for IIP/IIP+/IIP                        | \$ 89     |
| HP Toner for I/II/III/IIID                       | \$ 99     |
| HP Toner for 4/4L                                | \$ 139/89 |
| HP 4 Level 2 Postscript (PP)                     | \$ 375    |
| HP 4 Level 2 Postscript (PP) + 4 M memory bundle | \$ 575    |
| HP 4 Multi size tray                             | \$ 110    |
| HP DeskJet 500 Ink Cart                          | \$ 28     |
| HP DeskJet 500 HC Ink Cart                       | \$ 43     |
| HP DeskJet 500C Color Cart                       | \$ 47     |
| Okidata 400 1M/2M memory                         | \$125/192 |
| Okidata 400e 1M                                  | \$160     |
| Okidata Image Drum OL400/800                     | \$ 265    |
| Okidata Toner for Laser                          | \$ 35     |
| Panasonic 4410/Raven 510 1M                      | \$ 135    |
| Panasonic/Raven Toner                            | \$ 45     |

### MEMORY

\* Please call to confirm prices.

|                            |        |
|----------------------------|--------|
| DRAM 44256-70              | \$ 8.5 |
| SIMM 256-70/80             | \$ 18  |
| SIMM 1M-60, 30 pins (call) | \$ 59  |
| SIMM 1M-70, 30 pins (call) | \$ 56  |
| SIMM 4M-70, 30 pins (call) | \$ 205 |
| SIMM 4M-70, 72 pins (call) | \$ 220 |
| SIMM 8M-70, 72-pins (call) | \$ 480 |
| SIPP 1M-70, 30 pins (call) | \$ 61  |

\* Memory for Acer, Compaq, DELL, IBM ps/1/2, P.Bell, Toshiba available

### KEYBOARDS

|                              |       |
|------------------------------|-------|
| BTC 101 Keyboard             | \$ 22 |
| Keytronic AT/XT ** USA **    | \$ 40 |
| Keytronic keyboard ** USA ** | \$ 62 |
| AT keyboard to PS/2 adaptor  | \$ 12 |

### VIDEO CARDS

|                            |        |
|----------------------------|--------|
| Monographics               | \$ 28  |
| Trident 512K               | \$ 60  |
| Trident 1M 32 bits color   | \$ 89  |
| ATI XL24 1M OEM            | \$ 130 |
| ATI XL24 1M & Mice OEM     | \$ 155 |
| ATI Gr UI + 2M original    | \$ 299 |
| ATI Gr UI Pro 2M OEM       | \$ 418 |
| ATI Gr UI Pro 2M original  | \$ 455 |
| ATI Gr UI Pro 2M VESA OEM  | \$ 429 |
| ATI Gr UI Pro 2M VESA orig | \$ 455 |
| VESA Cirr Logic 5428 1M    | \$ 139 |
| VESA Cirr Logic 5428 2M    | \$ 205 |
| VESA Trident 1M            | \$ 124 |
| VESA Trident 2M            | \$ 195 |

### MONITORS

|                             |         |
|-----------------------------|---------|
| Datas 14" TTL paper white   | \$ 127  |
| IBM 12" Mono VGA *No box    | \$ 120  |
| Datas 14" 1024 .39          | \$ 269  |
| Datatrain 14" 1024 .39      | \$ 279  |
| Datatrain 14" 1024 .28      | \$ 315  |
| Megalmage 14" 1024 .28      | \$ 299  |
| Megalmage 14" 1024 .28 NI   | \$ 329  |
| Tatung 14" 1024 .28 low-rad | \$ 450  |
| Megalmage 15" 1280 .28      | \$ 495  |
| Datatrain 17" 1280 .28      | \$ 950  |
| Mitsubishi Diam. Scan 15FS  | \$ 635  |
| Mitsubishi Diam. Pro 17     | \$ 1239 |
| Mitsubishi Diam. Scan 17FS  | \$ 1350 |
| NEC 3V 15" 28 1024          | \$ 735  |
| NEC 4FGe 15" .28 1024       | \$ 949  |

### CD ROM

|                                |        |
|--------------------------------|--------|
| Mitsumi int 350ms 150k/s Kit   | \$ 199 |
| Mitsumi int 250ms 350k/s Kit   | \$ 279 |
| Panasonic int 320ms 300k/s Kit | \$295  |
| Philip int 350ms 300k/s Kit    | \$ 285 |
| ** Special 6 CD Titles         | \$ 130 |

### MATH CO-PROCESSOR

|                               |       |
|-------------------------------|-------|
| 387SX, 16/20/25/33/40 Mhz     | \$ 85 |
| Cyrix 387DX, 25/33/40 Mhz     | \$ 75 |
| ITT, ULSI 387DX, 25/33/40 Mhz | \$ 75 |

### FAX MODEMS

\*\* 5 years Warranty GVC/USR \*\*

|                              |        |
|------------------------------|--------|
| 96/24 Send/Rec fax int Modem | \$ 59  |
| GVC 96/24 Int S/R fax Modem  | \$ 78  |
| GVC 96/24 Ext S/R fax Modem  | \$105  |
| GVC 14.4 Int s/r fax v42 v32 | \$ 209 |
| GVC 14.4 Ext s/r fax v42 v32 | \$ 225 |
| GVC PCMCIA s/r fax modem     | CALL   |
| USR 14.4 Int s/r fax v42 v32 | \$ 219 |
| USR 14.4 Ext s/r fax v42 v32 | \$ 239 |
| WinFax 2.0 for GVC only      | \$ 28  |
| IO card with one 16550 port  | \$ 40  |

### OTHERS (Original Packaging)

|                              |        |
|------------------------------|--------|
| Optical Glass Filter         | \$ 35  |
| MS compatible mouse          | \$ 15  |
| Keytronic mouse              | \$ 28  |
| Microsoft mouse v2.0 OEM     | \$ 50  |
| Logitech Mouseman *New       | \$ 80  |
| Logitech Trackman *New       | \$ 99  |
| Logitech Scanman 256         | \$ 228 |
| Logitech Scanman Easytouch   | \$ 338 |
| VideoBlaster bundle          | \$ 449 |
| SoundBlaster compatible      | \$ 66  |
| SoundBlaster Pro Deluxe w/CD | \$168  |
| SoundBlaster Pro Deluxe noCD | \$145  |
| SoundBlaster Pro 16 Basic    | \$ 199 |
| SoundBlaster Pro 16 ASP      | \$ 285 |
| Speaker ( Basic )            | \$ 15  |
| Speaker SB-668               | \$ 30  |
| Joystick Bondwell GS-123     | \$ 30  |
| Joystick Gravis              | \$ 48  |

### SOFTWARE

|                             |        |
|-----------------------------|--------|
| BusinessVision II           | \$ 135 |
| CA Textor for Windows       | \$ 50  |
| CorelDraw 4.0 upgrade       | \$ 279 |
| dBase IV 2.0 upgrade        | \$ 135 |
| Lotus 123 4.01 Win upgrade  | \$ 140 |
| MS DOS 6.0                  | \$ 48  |
| MS DOS 6.0 to 6.2 upgrade   | \$ 16  |
| MS DOS 6.2                  | \$ 59  |
| MS Windows 3.1              | \$ 65  |
| WP 6.0 Windows upgrade      | \$ 159 |
| WP 6.0 Windows full version | \$ 400 |
| WP 6.0 DOS comp. upgrade    | \$ 159 |

# No Hands Software Ships Common Ground For Windows

BELMONT, CALIFORNIA (NB)—No Hands Software fired the latest salvo in its ongoing battle with Adobe Systems in the electronic document distribution market, by shipping the Windows version of Common Ground this week. The company claims that the product is "the first commercially available, cross-platform competition to Adobe Acrobat."

The firm maintains that Common Ground 1.0 for Windows retains all of the important features found in the company's Macintosh version, which was shipped in May, 1993. Features include an embeddable, free, compact MiniViewer, and pixel-for-pixel

**Common Ground also acts as an OLE 2.0 server, providing "seamless" integration into other applications.**

el fidelity to the original document. The product also offers full Postscript support, JPEG (Joint Photographic Experts Group) compression, and the ability to save documents into popular word processing formats for editing.

The company says that Common Ground also acts as an OLE (object linking and embedding) 2.0 server, providing "seamless" integration into other applications such as electronic mail and databases.

In announcing the shipments, Tony Stayner, vice president of marketing at No Hands Software, said: "Common Ground users can send documents with confidence they can be viewed and printed, because Common Ground lets them include a small, free MiniViewer, which runs on a minimal system configuration. Also, Common Ground users can always count on an exact representation of their original document, because Common Ground works well with all font types including TrueType, PostScript, and international character sets."

The company claims that, in contrast, Adobe Acrobat requires that viewers be installed everywhere a user wants to send a document.

No Hands says it has incorporated Zenographics' ZScript PostScript processor technology into Common Ground 1.0 for Windows to provide full PostScript support. Users can also "distill" Common Ground documents from any PostScript file, in order to get documents from other platforms into Common Ground's platform-independent format, where they can be viewed and printed.

Built-in JPEG compression is also included, for compressing continuous-tone grey scale and color images in order to reduce the size of files.

According to the company, Common Ground is an electronic document distribu-

tion program that lets users "convert any document to an exact representation of the original that can be viewed, searched and printed by anyone regardless of application, computer, and fonts."

Two major components make up Com-

mon Ground: a Maker and a Viewer. The CG Maker converts any document from any application to DigitalPaper, a platform independent file, which can be viewed and printed by anyone with a Common Ground viewer. The Common Ground Viewer features

copy and paste options, text searching, zoom capabilities, navigational tools, OLE 2.0 server support, and on-line help. The MiniViewer features viewing and printing only.

Common Ground for Windows requires

*Continued on page 57*

# ~~RENT SOFTWARE~~

**Due to changes in the law, MEGAChoice Software can no longer rent software! We are liquidating all our inventories at unbelievably low prices.**

DBASE IV 2.0-\$179  
HARVRD GRPHX2-\$99  
SOUND BLASTER  
DELUXE-(NEW)-\$89



A-TRAIN-\$10.00  
LINKS COURSES-\$9.00  
DAY OF THE  
TENTACLE-\$29.99

**BUY ANY THREE PROGRAMS GET ONE FREE!  
JANUARY 29, 30 (SAT, SUN) ONLY! \***

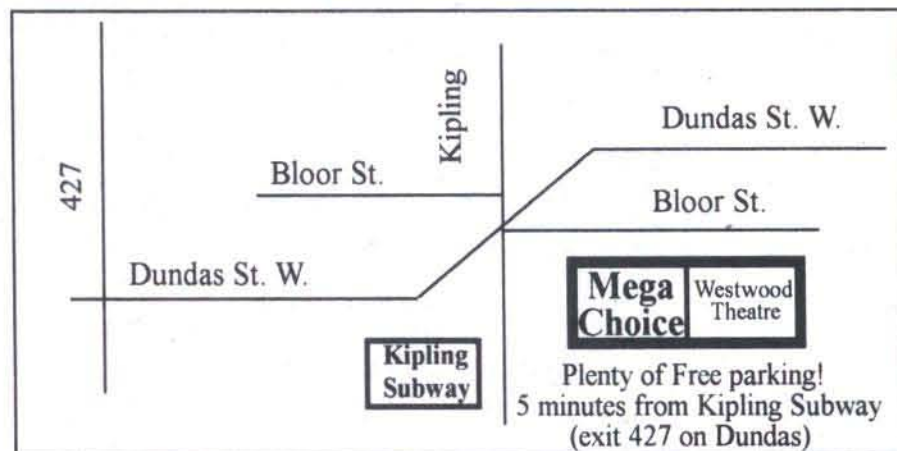

**3747 Bloor St. W, Etobicoke,  
233-8435**

**Liquidating three stores and thousands of titles! \*For equal or lesser value.**

AC  
Systems

## High-Performance Computer Systems

Now for  
*unbelievable prices !!!*



Individual Solutions for CAD, Database Management, Desktop Publishing, Photo-Development, Graphic-Development & Presentation, Animation, Spreadsheet, High-Speed Printing, Software Development, ...

**AC486DX-33** 1 Year Parts & Labor Warranty! \$ 1355.00

- Intel 486DX-33MHz CPU
- 3x32bit VLB & 5 ISA Slots
- OPTI Chipset, 128KB Cache
- 4MB RAM (128MB max.)
- 3.5" 1.44MB FDD, 120MB HDD
- 32-bit VLB IDE Controller
- 1MB Window Accelerator Video Card
- 101 Keyboard & 3-button Mouse
- 14" SVGA Monitor 1024x768, 0.28

|   |   |
|---|---|
| <p>AC486DX2-50: \$1415.00</p> <p>AC486DX1-50: \$1555.00</p> <p>AC486DX2-66: \$1599.00</p> <p>AC486DX2-80: \$2199.00</p> | <p><b>OPTIONS:</b></p> <ul style="list-style-type: none"> <li>- 256KB Cache</li> <li>- 8/16/32/64/128 MB RAM</li> <li>- 15/17/21" Monitor</li> <li>- Hard Drives up to 2.9GB</li> <li>- Modem, CD-ROM, Network Card, Tape Backup</li> <li>- High Performance Video Card / HDD System</li> </ul> |
|---|---|

72 hour burn-in test! Free software-installation & free delivery!

FOR FURTHER INFORMATION OR PURCHASING CALL (416) 449-0311 OR FAX (416) 449-0596.  
The Intel Inside Logo is a registered trademark of Intel Corporation.

# KV COMPUTERS

1182 STREAMBANK DR., MISSISSAUGA, ON

(905) 278-4373

THE PERFECT BALANCE: HIGH Quality  
at LOW Prices!

**486SLC33**

- 2MB RAM
- 105 MB hard drive
- 3.5" floppy drive
- 14" SVGA 1024x768 color monitor
- 512K video card
- 101 enhanced keyboard
- mouse
- minitower or desktop case
- super I/O controller 2S/1P/1G

\$929

**486DX33 VESA local bus**

- 4MB RAM
- 250MB hard drive
- 3.5" floppy drive
- 14" SVGA 1024x768 color monitor
- 1MB video card
- 101 enhanced keyboard
- mouse
- minitower or desktop case
- super I/O controller 2S/1P/1G

\$1449

...Specials...

|                         |       |                                       |       |
|-------------------------|-------|---------------------------------------|-------|
| 14.4 fax modem          | \$157 | 386SX40 motherboard                   | \$81  |
| 356MB hard drive        | \$369 | 14" SVGA 1024x768                     | \$251 |
| 486SLC33 motherboard    | \$129 | 15" SVGA 1280x1024 .28 NI flat screen | \$459 |
| Minitower case with LED | \$57  |                                       |       |

VOMAX 2000 - THE ULTIMATE MOBILE AND HOME OFFICE - VOICE MAIL / FAX MAIL / MODEM



- FAX MAIL BOX
- VOICE MAIL BOX
- DATA MODEM
- DIGITAL ANSWERING MACHINE
- REMOTE ACCESS
- REMOTE FAX TRANSFER
- PAGER ALERT
- PC OR MAC
- SOFTWARE INCL.

**Center Piece of the Home Office**

The Vomax 2000 is available for Macintosh or PC systems, serves as a data modem, and comes with all the hardware and software needed to make your home office fully automated and functional. Vomax works from one single home or business telephone line, and is completely compatible with Windows 3.1, DOS, Mac, Desktop, and portable units. The Vomax 2000 is the answer to your home office needs. Call us today to increase your home office productivity!

SPECIFICATIONS

- Stand alone operation or a PC/Mac interface
- 110 V or 220 V options
- Receive & Store Fax Mail
- Send Fax from your computer
- Single session Remote Access
- Forward faxes to any fax
- Configure VOMAX remotely
- Alerts your nationwide pager
- Expandable memory (up to 8x)
- Battery Back-up
- 9600 BPS Group III Fax, CCITT T.4, T.30, V.29 V.27 ter. V.21 sync.
- Modem with CCITT V.21, V.22, V.22 bis Bell 103, and 212a.

C.E.I.D. Corporation

5050 Rue Paré, Suite 210  
Montreal, Quebec H4P 1P3  
Tel. (514) 341-2020 • Fax (514) 341-2039  
Dealer Inquiries Welcome

PERSONAL COMMUNICATORS

# General Magic Demonstates Cap

BY LINDA ROHRBOUGH

SAN FRANCISCO, (NB) — General Magic publicly demonstrated for the first time at both the Winter Consumer Electronics Show and Macworld the previously announced Magic Cap software environment for personal communicators. This new environment will be the underlying technology in hand-held personal communicators yet to be announced from Sony, Motorola, Matsushita, and Phillips.

General Magic was formed out of an alliance between Apple, American Telephone and Telegraph (AT&T), Motorola, Sony, Matsushita, and Philips Electronics. While Apple and AT&T have both announced personal digital assistants (PDAs), the main difference between the PDAs and the personal communicators that will use Magic Cap is that PDAs are designed around the model of an organizer, while personal communicators are focused on communications.

Overlap in functionality between the two types of devices is expected, however, and Apple has even said it will use portions of the Magic Cap environment in future Newton PDAs.

According to General Magic, the Magic Cap environment includes everything people need to interact through popular modes of communication, including: fax, public electronic mail services, and telephones. A major portion of Magic Cap, the portion Apple plans to use is Telescript, a programming language that allows users to launch "electronic surrogates" or "agents" on electronic networks to perform intelligent tasks. For example, a user might design an agent to monitor an electronic airline service and send a message by fax or electronic mail if the flight is late or canceled.

General Magic officials say agents can perform tasks such as screening, routing and delivering electronic correspondence as well as shopping for goods and services.

In addition, Magic Cap will offer functions to manage personal information such as address cards that automatically get updated as the sender's information changes, a calendar that issues invitations to meetings, and a notebook that supports free-form and structured notes.

A version of Magic Cap is planned for IBM and compatible personal computers (PCs) and Apple Macintosh computers, but

will not be available until the second half of 1994, company officials said. Once available, users with personal communicators and desktop computers will be able to connect the two and reconcile data between each one.

Twenty developers announced product and service plans for the new personal communicator devices. One of the developers was Radiomail, who announced a two-way wireless communication product for Magic Cap. Radiomail's two-way gateway service uses the RAM Mobile Data or ARDIS radio frequency networks, which cover business centers nationwide.

Pat Richardson, vice president and general manager of Motorola's Subscriber Products Division, said, "Radiomail's two-way wireless messaging is an essential application for the new generation of personal communicators. These devices enable people to send and receive messages at any time, wherever they are. When a message is sent, Radiomail seeks out the user and delivers it wirelessly whenever the device is on. Likewise, the user can respond immediately — there's no need to find a phone."

Oracle, known for its cross-platform database software, announced it is working with General Magic on integrating the Magic Cap platform with the Oracle Media Server. Oracle was to make a worldwide announcement in January, of the Oracle Media Server which it claims will be a critical part of the information highway. The company claims the Media Server can process thousands of transactions per second and manage the multiple data types (such as audio, video and text) that are required for interactive business and consumer services.

Marc Porat, chairman of the board and chief executive officer at General Magic, said: "We feel the Oracle Media Server is one of the key links in enabling the Information Age. The combination of Magic Cap with the Oracle Media Server will speed the delivery of interactive services in a variety of business and consumer applications."

Handheld personal communication devices that use Magic Cap are expected in the first half of 1994, according to General Magic officials.

Contact: General Magic, 415-966-6707

NEXT ISSUE ...

• TELECOMMUNICATIONS • BBS LIST •

AD DEADLINE: Wed. Feb. 2  
DISTRIBUTION DATE: Fri. Feb. 18

Call (416) 588-1580  
for advertising information

**REEXAMINATION**

# Compton's Patent, Take 2

BY LINDA ROHRBOUGH

WASHINGTON, D.C. (NB) — Patent and Trademark Commissioner Bruce Lehman says he has ordered a reexamination of the multimedia patent granted to Compton's Newmedia in August.

Lehman says he ordered the move following the US Patent and Trademark Office's discovery of new information not considered by the patent examiner before issuing a multimedia patent.

The US Patent Office has come under fire by trade groups and multimedia developers for issuing "broad, non-technical" patents and the Compton's Patent has been one of the most controversial. "Right now we're taking a second look at a patent that has prompted a strong and concerned reaction in a particularly dynamic and changeable industry," Lehman said.

In the reexamination, PTO said it would look again at all claims in the patent to determine whether Compton's claim is indeed "new" and "non-obvious," the key criteria for awarding patents. Patent office officials were unable to offer information as to what specific evidence has been unearthed prompting the reexamination.

Compton's Newmedia announced at the Comdex computer trade show in November it was issued a patent number 5,241,671 for the "Multimedia search system using a plurality of entry path means which indicate inter relatedness of information." The patent essentially makes the outrageous claim that Compton's invented multimedia, according to the Interactive Multimedia Association (IMA), a trade group with 260 member companies participating.

Compton's caused further flurries at the announcement by also announcing a royalty schedule for those using multimedia in everything from compact disc read-only memory (CD-ROM) to electronic online services and planned interactive television services.

This is the second multimedia patent the Patent Office is reexamining. The first, granted to educational multimedia software developer Optical Data Corporation (ODC) of New Jersey is for "Curriculum planning and publishing methods."

It is one of two patents ODC received in 1992, the other being "Interactive method for the effective conveyance of information in the form of visual images."

When challenged legally by multimedia developer Videodiscovery of Seattle, Washington, ODC placed the first patent in the public domain and asked the second be re-examined rather than have its validity determined by legal processes. Videodiscovery said it challenged ODC because ODC was using the patent to discourage Videodiscovery customers.

PTO says interested parties can view the Compton's patent and reexamination documentation at it's Public Search Room, 9 am to 5 pm Monday through Friday in Crystal Plaza 3, Crystal City, Arlington, Virginia.

In addition, PTO says it will hold public hearings to address questions and concerns surrounding the issuance of patents for software inventions. Two hearings are planned: one for January 26 and 27 at the San Jose Convention Center in San Jose, CA and the other February 10 and 11 at the Crystal City Forum in Arlington, VA. ■

**The patent essentially makes the outrageous claim that Compton's invented multimedia, according to the Interactive Multimedia Association.**

**No Hands**

Continued from page 55

Windows 3.1, a 386 microprocessor or faster and two megabytes (MB) of RAM (4MB recommended). Using the CG PostScript Extension requires 4MB of RAM (6MB recommended).

The company is offering the Windows and Macintosh versions immediately for a special introductory price of US\$99.95. That goes up to \$189.95 after the introduction.

The Macintosh version of Common Ground, according to a company spokesman, will catch up to the feature list of the Windows release in two stages. Version 1.1, which will add JPEG compression and word processor compatibility, was to be

released in Jan., but full PostScript capabilities won't be added until version 2.0 appears sometime this summer.

Until products such as Acrobat and Common Ground, electronic information distribution across different computer platforms was usually limited to text files—the "lowest-common-denominator" file type, which doesn't allow documents to retain formatting or graphics.

Acrobat and Common Ground allow users to send formatted documents created on their computers to any other computer—even if it uses a different operating system and even if the recipient has neither the original software nor the original fonts. ■

Contact: No Hands Software, 415-802-5800.

**EFFECTIVE PHONE LINE SHARING SOLUTIONS**

**1. RING READER** - works with Ident-A-Call® service. You get Three Telephone Numbers on One Telephone Line and you can assign them each for Phone, Fax and Modem. You can save up to **\$1,300.00** in Phone Bills each year. \*also known as 'Smart Ring' Proven accurate performance. Thousands of happy users. **SATISFACTION GUARANTEED!**

**SPECIAL OFFER!**

Ring Reader 2-Port for 2 Telephone Numbers **\$79.99**  
Ring Reader 3-Port for 3 Telephone Numbers **\$99.99**

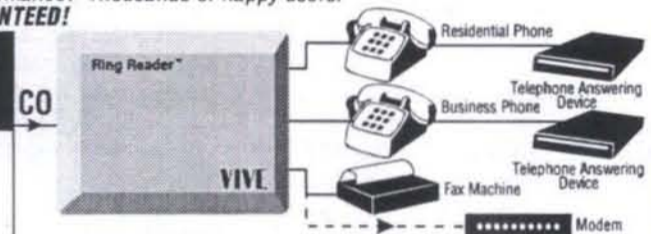

**2. SMARTMAX II** - works with any Telephone Line. No Ident-a-Call Service required! Phone/Fax/Modem Routes calls automatically to Phone, Fax and Modem.

**CALLER ID INTEGRATION FOR ANY DOS OR WINDOWS APPLICATIONS** Particularly ACT! for Windows

WindowsHinge integrates Call Editor with ACT! for Windows upon installation and with any Windows application through DDE (MacHinge for ACT! for Macintosh and any MAC application will be available soon).

- Automatic Call Logging for Date, Time, Calling Line No. or Called No., Duration of Call on inbound and outbound calls
- Automatic Call Recording of 2-way conversation with Time and Date Stamping (when used with Voice System)
- Automatic File Retrieval
- Single-line or Multi-line applications
- Auto Dialling from screen



**SPECIAL OFFER!**

Call Editor II + WindowsHinge **\$199.99**  
Call Editor RSA + WindowsHinge **\$119.99**

**VIVE® Synergies Inc.** **DEALER ENQUIRIES WELCOME!!!** Tel: (905) 882-6107 Ext. 16, 25 or 20 Fax: (905) 882-6238 30 West Beaver Creek Road, Unit 2, Richmond Hill, Ontario L4B 3K1

**Only \$99** Save Up To 80% of Your PC's Energy Costs Plus Extend Your Monitor & Printer Life

**NEW PC Energy Saver**

- The PC Energy Saver is Only \$99 - Can pay for itself in less than 1 year
- Operates just like a Screen Saver; Programs to Turns the Printer and/or Monitor OFF and ON at a specific time or when it detects inactivity
- Saves up to 80% of PC's total energy costs
- Extends monitor and printer life
- Controls monitor & printer power independently
- CPU remains on for background activity such as E-Mail, Spooled Printing or Network Activity

Dealers & VARs Wanted

Available From: **P.P.I.** Visa & Master Card (905) 629-3737 Toll Free 800-267-4686

**Turn Any Fax Machine Into A Full Page Scanner** **From Only \$99**

This Wonder Device Gives You The Power of a Full Page Scanner at a Fraction of The Price of a Handheld Scanner

**faxscanner - \$99**

- Scan full pages of text, graphics, images up to 11"x17" size
- Use with any G3 Fax machine
- Compatible with all major Desktop Publishing Software
- Portable, compact, convenient!
- 200 x 200 DPI, grey scale support
- Windows & Mac Versions (\$109)

**Best Buy** **faxscanner International - \$199** Plus OCR for 11 languages (Inc. French)

- Get the faxscanner plus (OCR) Optical Character recognition software by CAERE
- For Windows

**faxscanner - \$399** With Deluxe TypeReader OCR (Win or MAC)

Dealers & VARs Wanted

The Computer Paper Makes A Pilgrimage To The Winter Consumer Electronics Show  
In Las Vegas And Discovers, Among Other Things

# MPEG's Just The Thing To Make A Player of A King

BY HARI SINGH KHALSA

**Dateline Teasetown** — The Consumer Electronics Show (CES) was again dominated by the games scene. SEGA and Nintendo filled one pavilion by themselves. Publishers great and small for both platforms dominated two other halls.

The computing world also had a significant presence as the content providers of the "zero-billion-dollar" industry turned out scores of new multimedia titles. Even computing heavyweights like IBM, Compaq, HP, and Intel played to the SOHO market by committing significant resources to the show.

On the games side, Sega showed its existing hardware, the best of which is the SegaCD unit. If there were any Saturns (Sega's 32 bit machine), I missed them. No question Sega leads the game-player market in the near term.

By comparison the SNES and SuperScope exhibits of Nintendo seemed lost in time; not quite current, yet not quite over-the-hill.

## If I Wanted One

My pick of the "player" machines at CES is the Atari Jaguar. It smokes every other currently-shipping game unit, just like the Atari Lynx smokes every other currently-shipping hand-held gamer.

And the price is right (\$US249.99).

The graphics quality surpasses the competitors, even 3DO (at half 3DO's price).

It's a pity The Jag will suffer the fate of other Atari products in recent years: lack of support and market share. Want proof? Compare the list of software publishers who are supporting the Jaguar vs. those developing for SNES, SegaCD/Saturn, and 3DO. It's no contest.

## 3DO Hoopla

3DO's marketing was extraordinary. I expected that. What I didn't expect was the quality of the demos running on banks of 3DO Real Multiplayers.

In a word, it was underwhelming.

3DO is good. It's just not good enough to justify the cost. Fortunately there are many applications for which Multiplayers are well suited. For example, someone will sell the airlines on installing seatback gamers to go along with the cellular phones et al. I sincerely hope that 3DO lands some of the seatback contracts, if only because one likely alternative is SNES. Let's entertain ALL the kids on the plane, not just the ones under seven. Besides, 3DO's sound is very good.

But 3DO in my home? Not if there is something better. And there is.

## MPEG

On a couple of 3DO units there were prototype MPEG boards (expected cost in the \$200 range, available this summer) boosting the machines capabilities. I broke stride when I saw the MPEG machine running side-by-side with a non-MPEG 3DO unit. What a contrast! Now this is multimedia. Maybe it was the lighting, maybe it was the

content. But the full screen display of those few units was outstanding. So long to herky-jerky full-screen video. So long to tiny Quick-time windows. Add to this 3DO's great sound and I would buy this level of quality.

But would I buy a stand-alone unit to run it on? For \$US700-800?

## Jim Clark, What's Behind Door Number One?

In the misty moors of the Nintendo exhibit was a video loop of SGI's Jim Clark hyping Project Reality (SGI engineered 64 bit Nintendo-of-the-future). Around the kiosk were two Indy development units and one Project R prototype.

Now I'm partial to what a creative genius can do with an SGI development machine; but so what? True, the piece running on the prototype showed promise. It bore a close kinship to the T2 and Jurassic Park work that has made Jim Clark's machines famous.

The Amazing  
**CD-32**  
Now In Stock

Come & Try It At Our Store!

ALSO IN STOCK!  
AMIGA 4000 SCSI CARDS

**AMIGA**

**293-0000**

**AMVILLE**  
COMPUTER SYSTEMS

2240 MIDLAND AVE.  
UNIT 102  
SCARBOROUGH

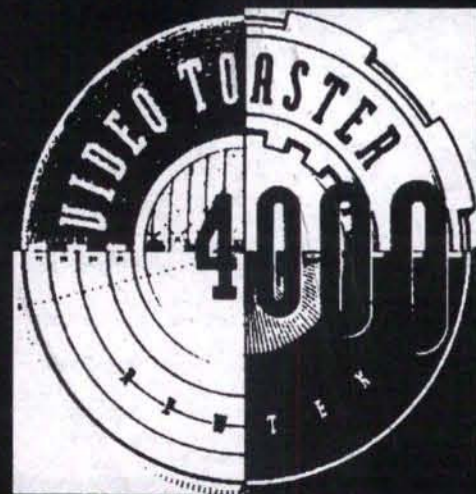



THE 'FEELIES' ARRIVE: Interactor is a vest that changes audio signals into sensations that are felt through pads on the front and back of the device.

But Project Reality's superior graphics won't be enough to make up for lost time. Even if it comes in at \$US200 (Jim's figure), it will arrive too late (in 1995). Why? The same reason 3DO will struggle against the current in homes across North America this year.

**The Tsunami Approaches Shallow Water All Other Waves Flatten In Anticipation**  
The computer-based games and edutainment

products shown in one section of CES will outsell all of the games developed for 3DO, Sega, Nintendo, the Jag, and all the other players that filled numerous pavilions at the show.

Why? The number of US and Canadian households with children under 14 that are purchasing their first computer outstrips the number purchasing their first game machine by a growing margin each month. Of the game machines, the king of the hill for new

sales is the SegaCD. But its sales are peanuts compared to sales of CD-ROM-equipped computers.

It is estimated that by the end of this year 20 percent of all North American households with children will have computers with CD-ROM drives. That, folks, is a sea change.

**The Season Of The Content Provider**

To satisfy the rising demand there are lots of new multimedia and interactive titles in the works for this coming year. Many of the good ones incorporate MPEG compression, requiring special hardware.

MPEG boards for PCs are available now and cost under \$US400. The quality of the MPEG titles outshine their older cousins just as 3DO with the MPEG add-on outshines straight 3DO. And, in a shocking departure from the fallibility of most new PC technology, the existing first generation MPEG boards work well.

Will the public buy yet another add-on for their computer systems?

**Out On The Limb We Go ...**

**Prediction #1 — Unequivocally yes**

The increase in storage capacity, as well as improved full screen video quality will make MPEG the standard video compression format for the foreseeable future. It is that good. Period.

Does this mean that all of the content developers have jumped or will jump on the MPEG bandwagon? Certainly not. Choice of video compression routine is only part of the increasing dilemma for developers. They all smell a growing market. But which format do they choose? 3DO with or without MPEG? MPC? MPC2? SegaCD? CD-I? The

demographics of recent purchasing patterns say MPC or SegaCD. But will those formats dominate far enough into the future to warrant the 6-18 month development time for new content? And how many developers can find \$500,000 - \$1.5M required to bring one title to market?

**Prediction #2 — Future multimedia title publishing will look like book publishing did prior to DTP.**

Developers will go for multiple platforms by riding on the coattails of established publishers. Companies like Time-Warner, Philips Interactive, and Sony Interactive will move way ahead of the pack on cash-flow from a stream of CD-ROM "reprints" of titles in their libraries of Software, Print, Movie, TV, etc.

By doing so they will establish themselves as having the clout to release titles in multiple formats. And the formats they will likely choose? MPEG and MPC2.

A few software houses like Microsoft, Konami and Capcom will use their distribution muscle and substantial cash to join them. Existing book publishers like MacMillan and Prentice Hall will join in too on the edutainment side. They too will likely publish MPEG and MPC2 titles, with some SegaCD format for the kids.

Developers will turn to them out of necessity much in the same manner that writers turn to book publishers to get into print. And the publishers, in turn, will make their fortunes based on choosing the right titles to release.

**Prediction #3 — (Why not? Jeanne Dixon does it.) The market leaders will be Time-Warner, Microsoft, and Philips. ■**

**Computer Base Men**  
357 College Street, Toronto, Ontario, M5T 1S5  
Tel: (416)413-0313 Fax: (416)413-0311

**Professional 486 Systems**

|   |   |
|---|---|
| VL-Bus Motherboard<br>128K On-board Cache<br>4 MB RAM<br>260 MB IDE Hard Drive<br>1 MB SVGA Video Card<br>14" .28DP SVGA Monitor<br>1.44 MB Floppy Drive<br>2 Serial, 1 Parallel and 1 Game Port<br>Mini Tower or Desktop Case<br>Enhanced 101-key Keyboard<br>Microsoft Compatible Mouse with Pad<br>DOS 6.2 and Windows 3.1 | <p><b>System with Intel 486SX-25 \$1395</b></p> <p><b>System with Intel 486SX-33 \$1440</b></p> <p><b>System with Intel 486DX-33 \$1640</b></p> <p><b>System with Intel 486DX-50 \$1860</b></p> <p><b>System with Intel 486DX2-66 \$1930</b></p> <p><b>System with AMD 486DX-40 \$1645</b></p> <p><b>System with IBM 486SLC-66 \$1585</b></p> |
|---|---|

\* ALL SYSTEMS HAVE 1 YEAR PARTS AND 5 YEARS LABOUR WARRANTY.  
\* ALL PRICES ARE CASH DISCOUNTED  
\* 3% WILL BE CHARGED FOR CREDIT CARD AND 2% FOR UNCERTIFIED CHECK.  
\* NO CASH REFUND, EXCHANGE ONLY WITHIN 7 DAYS.  
\* ALL PRICES ARE SUBJECT TO CHANGE WITHOUT NOTICE

**Multimedia**

|                                       |          |
|---------------------------------------|----------|
| Mitsumi 0500U Internal CD-ROM         | \$218.00 |
| SONY 31A Internal CD-ROM              | \$218.00 |
| SONY 33A DP Internal CD-ROM           | \$273.00 |
| Panasonic 562 DP Internal CD-ROM      | \$293.00 |
| Toshiba XM-3401B SCSI Internal CD-ROM | \$499.00 |
| Sound Blaster Pro Basic               | \$118.00 |
| Software Bundle 4-Titles              | \$ 35.00 |
| Software Bundle 6-Titles              | \$ 85.00 |

**CD Titles**

|                       |         |                    |         |
|-----------------------|---------|--------------------|---------|
| Animals               | \$23.95 | Family Doctor      | \$33.95 |
| Atlas U.S. & World    | \$23.95 | Groliers Ency.     | \$74.95 |
| Battle Chess          | \$19.95 | Great Cities Combo | \$21.95 |
| Carmen Sandiego       | \$35.95 | Guinness Records   | \$29.95 |
| Chessmaster 3000      | \$22.95 | Kodak Photo CD     | \$19.95 |
| Compton's Ency.       | \$74.95 | Mayo Health Clinic | \$29.95 |
| Dict. of Living World | \$44.95 | M.S. Bookshelf '93 | \$74.95 |
| Dinosaur Adventure    | \$29.95 | M.S. Works         | \$74.95 |
| Family Choice         | \$31.95 | Reference Library  | \$23.95 |

**Multimedia Systems**

VL-Bus Motherboard  
128K On-board Cache  
4 MB RAM  
260 MB IDE Hard Drive  
1 MB SVGA Video Card  
14" SVGA .28DP Monitor  
Panasonic Double Spin CD-ROM  
Sound Blaster Pro  
1.44 MB Floppy Drive  
2 Serial, 1 Parallel and 1 Game Port  
Mini Tower or Desktop Case  
Enhanced 101-key Keyboard  
Microsoft Compatible Mouse with Pad  
DOS 6.2 and Windows 3.1

**Intel 486DX-33 System \$1999**

**IBM 486SLC-66 System \$1965**

**Entry Level Systems**

2 MB RAM  
130 MB IDE Hard Drive  
512K Video Card  
14" VGA Mono Monitor  
1.44 MB Floppy Drive  
2 Serial, 1 Parallel and 1 Game Port  
Mini Tower or Desktop Case  
Enhanced 101-key Keyboard  
Microsoft Compatible Mouse with Pad  
DOS 6.2 and Windows 3.1

**386SX-40 System \$ 940**

**386DX-25 w/128K Cache \$ 990**

**386DX-40 w/128K Cache \$1025**

**In-Stock**

|                       |          |
|-----------------------|----------|
| <b>Motherboard:</b>   |          |
| 386DX40 w/128K        | \$155.00 |
| 486SX33 w/128K        | \$278.00 |
| 486DX33 w/128K        | \$480.00 |
| 486DX50 w/128K        | \$695.00 |
| 486DX66 w/128K        | \$765.00 |
| <b>Hard Drive:</b>    |          |
| 130 MB Segate         | \$256.00 |
| 260 MB Segate         | \$319.00 |
| 340 MB Segate         | \$405.00 |
| <b>Floppy Drive:</b>  |          |
| 1.2 MB Floppy         | \$ 63.00 |
| 1.44 MB Floppy        | \$ 55.00 |
| <b>I/O Card:</b>      |          |
| IDE I/O (2S, 1P, 1G)  | \$ 15.00 |
| VL-Bus IDE I/O        | \$ 30.00 |
| <b>Video Card:</b>    |          |
| SVGA W/512K           | \$ 52.00 |
| SVGA W/1024K          | \$ 74.00 |
| Cirrus Logic VLB 1 MB | \$110.00 |
| <b>Monitor:</b>       |          |
| 14" SVGA .28DP INT.   | \$299.00 |
| 14" SVGA .28DP M      | \$328.00 |
| <b>Case:</b>          |          |
| Mini Tower Case       | \$ 73.00 |
| Desktop Case          | \$ 73.00 |
| Mid-Tower Case        | \$105.00 |
| Full-Tower Case       | \$165.00 |
| <b>Printers:</b>      |          |
| Panasonic 1180X (9p)  | \$175.00 |
| Panasonic 2023 (24p)  | \$259.00 |
| Panasonic 2123 (24p)  | \$295.00 |

**COUPON**  
Bring in for a  
**FREE**  
**Screen Filter**  
With system purchase only.

CONSUMER ELECTRONICS SHOW

# Sega vs Nintendo

## Games Giants Battle For Turf

BY DANA BLANKENHORN

LAS VEGAS (NB) — The South Hall of the Las Vegas Convention Center, across Desert Inn Drive from the main hall, was totally occupied by just two exhibitors. But these were no ordinary exhibitors. These were those masters of the videogame universe, Nintendo and Sega.

The 1992 book "Game Over" left Nintendo on the verge of taking over the world. That, like Napoleon's conquest of Moscow, Hitler's conquest of Stalingrad, or Japan's own follow-up to Pearl Harbor, turned out to be reversible after all.

Sega now claims 55 percent of the installed base of "16-bit" game machines, with its Genesis now far ahead of Nintendo's Super NES. Sega's "Sonic the Hedgehog" character is now a \$1 billion market in his own right, and February 2 will see the launch of "Sonic 3" in, of all places, Punxsatawny, Pennsylvania—home of Groundhog Day.

Sales of the hand-held Sega Game Genie device rose 200 percent in 1993. And Sega has played a very clever hand in getting licensed characters onto games it designs. Its baseball, football, and basketball games are endorsed by professional leagues and players, and its kids' games feature hot character's like Disney's Aladdin and Barney the Dinosaur.

Nintendo hasn't been silent, and its Win-

ter CES empire still looked a trifle larger than Sega's. It's launching a Super NES game endorsed by Ken Griffey Jr., a new car racing game called Stunt Race FX designed by Shigeru Miyamoto (Mario's own creator), and a host of other titles with Nintendo-created characters like Mario and Kirby — the latter is like a Pac-man with personality. On the technology front, it's put Nintendo Gateway players into seat backs on major airlines, in hotels, and on cruise ships, and it's demonstrating "Project Reality," a CD-based game system designed with Silicon Graphics.

The weakness of both companies, as Trip Hawkins of 3DO was quick to point out at his own Winter CES press conference, is that neither Sega nor Nintendo is up-to-date on CD technology. Sega's Sega CD plays music CDs, cartridge games and CD games, but only with the 16-bit technology of the Genesis system. Nintendo's "Project Reality" game machine is at least a year from the market.

The most fearsome point, however, is the size and power of both contenders. Nintendo, which started off making playing cards, is now one of the largest companies in all Japan — right up there with Sony, Matsushita, Mitsubishi and NEC. Sega, at least in the US, has reached a nearly equal size. Between them, they were like Sumo wrestlers standing among a group of boxers, huge and surprisingly agile. ■

# WIN LOTTO!

## GAIL HOWARD'S SMART LUCK® LOTTERY SYSTEMS

### Won 39 Lotto Jackpots Worth \$79.2 Million Dollars!

The ONLY Systems with documented JACKPOT WINNERS.



Gail Howard is the undisputed authority on lottery strategies used in the world today. Her remarkable success is helping people win big money in Lotto has led to appearances on hundreds of radio and TV shows, including *The Today Show* and *Good Morning America*.

"Last November 8th, I hit the jackpot to the tune of \$1,096 million dollars. I hit one 6-number prize, two 5-number prizes and three 4-number prizes from your system 503. What a joy and excitement! I'm working on my second jackpot because with your system it's very seldom that I don't collect some prizes."

— Marie Cloarec, Canada Lotto 6/49

"After reading Gail Howard's book, I have won 18 prizes to date. In my first week of play, I won seven prizes. In the 2nd, 3rd and 4th weeks, I won one prize each draw, in my 6th week of play, I won the first prize jackpot of \$516,234.80 plus eight other prizes."

— Max Harrell, Canada 6/39 Lottario

### LOTTO HOW TO WHEEL A FORTUNE

This 397-page book contains the world's most successful lottery systems including ALL the systems used by Gail Howard's biggest Lotto jackpot winners. Easy to use as A-B-C. US \$19.50 + US \$5.00 S/H

"Gail Howard's program is the market's most comprehensive and incisive ... easy to install ... technical support is excellent ... Advantage Plus meets its claims. For the serious lottery enthusiast, it's the one to buy!"

— Cost Compute magazine

"Advantage Plus™ is the most user friendly software on the market, also the most professional and complete program ever devised for Lotto ... the ultimate lottery software for the serious lottery player."

— Computer Monthly magazine

"Lottery guru Gail Howard ... can help people beat the odds."

— Family Circle

"Wheeling systems like (Gail) Howard's have the most respectability among critics, since they concede that the wheels off a systematic way of reducing the odds"

— New York Daily News

"Leavelle Carter ... and Sherry Jaynes ... both won big jackpots by using Miss Howard's system. Mr. Carter bet \$13 and won \$606,023 in the D.C. Lotto game; Mrs. Jaynes hit a \$13.8 million jackpot in the New York state lottery ... On August 2, an Indiana couple hit the Canadian lottery for \$516,000. Two days later, 16 co-workers at a Miller Brewing plant in Clay, NY split more than \$1.4 million. All used Miss Howard's system."

— Washington Times

## Gail Howard's SMART LUCK® Software for your IBM/Comp. Computer

### ADVANTAGE PLUS™

Use ADVANTAGE PLUS™ and you'll trash all your other lottery software. It's the most complete, fastest and easiest to use — in a class by itself. Nothing else can begin to compare!

• COMPLETE drawing results for all Canadian Lotto Games from 1982 to present • Over 50 scientific charts and reports to zero in on winners • 86-page manual on disk tells how to identify winning patterns • Automatic SMART PICKS™ selects best Lotto #s instantly • Test past accuracy of SMART PICKS™ with one key stroke • A \$295.00 value. Your introductory price for a limited time only US \$79.95 + US \$5.00 S/H

### COMPUTER WHEEL™

Easy to use scientific systems that reduce the odds. Has 252 Lotto Wheeling Systems, each with a specific win guarantee. Guaranteed flawless. Find one system that fails its win guarantee and you get DOUBLE your money back! (COMPUTER WHEEL™ and ADVANTAGE PLUS™ — a winning combination!)

• These systems cost as little as two dollars to play, or you can wheel up to 40 of the 49 numbers in your game • Shows the minimum and maximum number of multiple prizes that can be won with each system • TIMES IN THE WHEEL handicapping feature tells how many times each number position is in the wheel so you can place your strongest numbers where they appear most often • Optimizing feature makes best possible sums of your chosen numbers • Saves up to 500 wheels for win checking • US \$39.50 + US \$5.00 S/H

### ADVANTAGE PLUS™ AND COMPUTER WHEEL™

Save \$20! Buy BOTH for only US \$99.95 + US \$5 S/H

We ship IBM/Comp. 5.25". Add US \$1.00 for EACH 3.5" disk (one per program).

**1-800-945-4245**

**SMART LUCK® Software**

Dept. P-7, P.O. Box 1519 • White Plains, NY 10602

For information call 914-761-2333

Name \_\_\_\_\_

Address \_\_\_\_\_

City \_\_\_\_\_ Province \_\_\_\_\_

Phone ( ) \_\_\_\_\_ Zip \_\_\_\_\_

Visa  MC Exp. Date \_\_\_\_\_

Card # \_\_\_\_\_

No Canadian dollar checks, please. Our U.S. banks slaughter us with the exchange and fees. U.S. dollar MO's welcome.

## CD-ROM Sales Top \$100 Million

BY JOHN MCCORMICK

WASHINGTON, DC (NB) — The Software Publishers Association reported sales figures for CD-ROM sales for the first three quarters of 1993. The numbers show that nearly 4 million discs shipped from January through September with a total value of nearly \$100 million and that sales are increasing.

Gathering its data from the sales reports supplied by 53 leading CD-ROM marketers, the SPA found that nearly 60 percent of the 3.86 million CD-ROMs sold went directly from the publisher to the end-user, the rest being sold through the reseller channel.

The value of the CD-ROM discs sold in the third quarter alone totalled \$38.3 million on sales volume of 1.3 million units, up from 1.2 million units (\$28.3 million) in the previous quarter and also above sales in the first quarter of 1993 which totalled 1.3 million units (\$30.4 million.)

The actual dollar value of units sold through the retail distribution channels was actually higher than that of those sold directly by the publishers because the units carried at the retail level tended to be more expensive.

Home education software accounted for 21 percent of the sales, with an increased percentage in the third quarter.

Databases and file collections accounted for the largest number of sales, totalling 40 percent for the three quarters.

Third quarter sales showed an increasing move toward retail as opposed to direct sales, indicating, according to SPA research director David Tremblay, that this marked the "beginnings of the development of a viable consumer market for CD software."

Contact: SPA, 202-452-1600

# Picks Of The CES Show

BY HARI SINGH KHALSA

## Eye Candy — Explora 1

Artist - Peter Gabriel  
 Publisher - Interplay  
 \$US60 (street)

Explora 1 is Peter Gabriel, through and through. Interplay found themselves preparing for CES with no Xplora to ship. They talked to Monsieur Gabriel about finishing the work to date so they could press just 5,000 copies, thinking that would buy them a couple of months so that Peter could finish the project in peace.

One teeny tiny problem. They sold out in under two weeks.

So Interplay has this delicious problem. They have seeded the U.S. market with 5,000 advanced copies of Xplora. But they don't know when they'll get the finished product.

When I was at the booth I watched a neatly-dressed female-exec type turn into this gushing computer nerd cum teeny bopper as she played it.

It worked for her. Worked for me too.

## Kid's Education — The Book of Shadowboxes

Publisher - EduQuest, an IBM company  
 Cost - \$US59.95  
 1-800-238-HOME/(215)458-6964

As I remember it, learning to read was one of my first great accomplishments. While Dick, Jane, and Sally2 remain etched forever in my memory, I wish the process had been more entertaining. I would have loved to learn with Shadowboxes. Shadowboxes is an interactive learn-to-read title. It either autoplays through the alphabet, for younger children to watch, or can be used interactively by older kids to involve them in the reading process. The artwork is rich and the reading clips are entertaining. It is easily my favorite CD title in the whole show.

## Coollest Software For Kids — Club Kidsoft

Publication - Club Kidsoft  
 Address - 718 University Ave., Suite 112  
 Los Gatos, Ca. 95030-9958  
 Cost - \$C25.95



Another pick in kids education was Club Kidsoft. Subscribers to Club Kidsoft receive a quarterly magazine that catalogues quality CD-ROM titles for children's edutainment. I

liked the values represented in their work and their attitude toward educating children. I expect them to answer the following question for many parents who seek a alternative to the PC game brain-drain: "Where can I find the coolest educational software for kids?"

## Just add goggles. It stirs for you.

Out of the ordinary - Interactor  
 Manufacturer - Aura Systems Inc.  
 Phone - 310-643-5300  
 Cost - \$US89

Interactor is a vest that uses audio signals to trigger the sensation of feeling via pads belt-

ed over the diaphragm area in front and the insertion of the diaphragm at the back. When hooked up to a shoot-em-up game it delivers the sensation of being shaken when there is an explosion. It may sound hokey but this is no QSound. The real-  
*Continued on page 62*

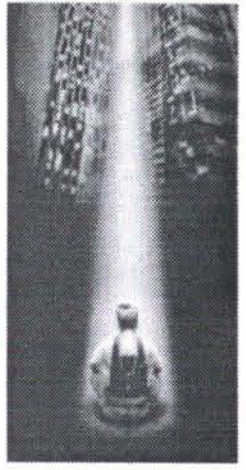

# MIT

COMPUTER SUPPLIES CO. LTD.

40 SHIELDS COURT, UNIT 1-2  
 MARKHAM, ONTARIO L3R 0M5  
 TEL: (905) 946-0908 or (416) 431-4373  
 FAX: (905) 946-8749 or 1-800-668-5225

50 WEYBRIGHT COURT, UNIT #46  
 SCARBOROUGH, ONTARIO M1S 5A8  
 TEL: (416) 321-2259

Monday to Friday 9 AM - 6 PM • Saturday 10 AM - 1 PM

## Find these products at MICROJACK Dealers:

Alpha Plus Computer  
 386 College Street  
 Toronto, Ontario M5A 3X6  
 Tel: (416) 323-0898  
 Fax: (416) 323-1064

Annubis Computing Canada Inc.  
 7725 Birchmount Road, Unit #12  
 Markham, Ontario L3T 9X5  
 Tel: (905) 470-0365  
 Fax: (905) 470-9201

Sogo PC Factory Corporated Centre  
 60 Yonge Street  
 Toronto, Ontario M5E 1H5  
 Tel: (416) 368-1122  
 Fax: (416) 368-1690

Sogo Computer Centre  
 310 College Street  
 Toronto, Ontario M5T 1R9  
 Tel: (416) 922-1111  
 Fax: (416) 922-6782

OTA Notebook Centre  
 343 College Street  
 Toronto, Ontario M5T 1S5  
 Tel: (416) 921-1177  
 Fax: (416) 921-8664

OTA Computer Centre  
 326 College Street  
 Toronto, Ontario M5T 1S3  
 Tel: (416) 922-1177  
 Fax: (416) 922-1603

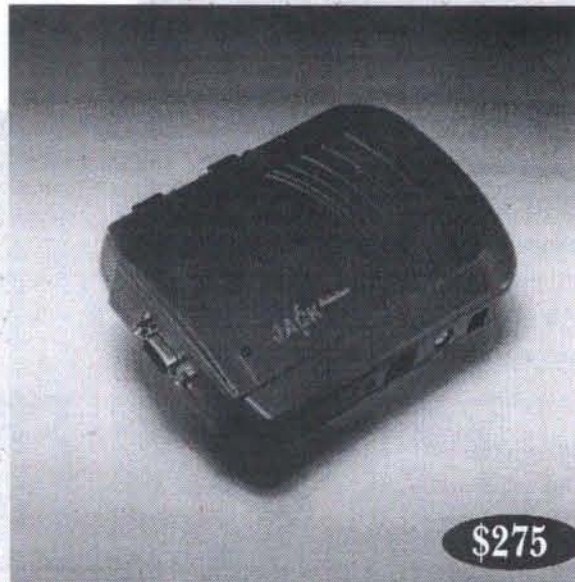

\$275

## VGA TO VIDEO CONVERTER

# JACK Selection

Run your VGA or MAC display on your TV!

Jack Selection is an external VGA to Video converter which can be used on any PC, laptop or notebook. Jack Selection displays up to 640 x 480 x 65,000 SVGA resolution on both the VGA monitor and the television set. Jack Selection comes standard with a flicker filter, positioning software, video cables and power supply. It also supports 3 video formats — S-Video, composite and RGB — in one of two video standards, PAL or NTSC. Jack Selection supports Windows 3.0 and 3.1

## Video Producer

Integrate the Graphics and Editing Power of VGA with the Presentation Power of VIDEO

Produce dynamic, high-quality video tapes and superb animation without a substantial hardware or software investment. The MicroJack series of overlay cards enables you to create professional video presentation by integrating and overlaying computer text, images, colors and special effects with input from live broadcasts, VCRs, camcorder and videodisc players. The Video Producer includes three cards: MicroJack VGA Pro, MicroJack HQO Pro and MicroJack TitleMate provide a myriad of applications from editing live television broadcasts, creating promotion and training tapes to producing new product presentations and educational programs. Bundled software: Deputy, CG by Shereff Systems, Inc.



\$439

## JACK<sup>2</sup> Selection PLUS SOUND

Run your VGA graphics and computer audio to your TV!

- Supports all IBM standard video modes and Hi-color modes (256/32K/64K)
- Resolution up to 640 x 480 in NTSC or 800 x 600 in PAL
- Under/Overscan and TV brightness control
- Supports 8/16 bits Wave and MIDI
- Built-in speaker & stereo output
- Input: Standard VGA
- Output: Composite Video, S-VHS Video, RGB and VGA

\$399

MICROJACK2000



\$499

2000 PRO

## LIVE VIDEO CONTROLLER

### MICROJACK 2000

Bring video from your VCR or camcorder onto your VGA screen

- Supports 640 x 480 in 16/256/32K/64K/16M colors and 800x 600 in 16/256/32K/64K colors
- Fractional zoom up to 1024 x 1024
- Video Input: Composite video
- Video output: 31.5 KHz RGB
- Real-time, horizontal/vertical panning
- Driver for "Video for Windows"
- Utilities & developer libraries available

### MICROJACK 2000 Pro

2000 With More Features

- New Media Graphics Super Video Window card compatible
- Instantaneous image capture with real time pan and zoom
- Supports most major image file formats (TIFF, PCX, BM, TGA, etc.)
- Easy-to-use DOS hot-key for customizing and manipulating video windows
- Audio input & output: Voice volume, bass, balance are software controllable

# Casio's Gadgets

LAS VEGAS (NB) — The spirit of the Winter CES show was on display at a press party hosted by Casio Inc. Its Japanese parent is the stern product of two driven brothers named Kashio. Its CES offerings are the kind of hip, quirky technology offerings that differentiate a consumer show from a computer show like Comdex.

How about a watch that doubles as a TV remote control? The CMD20, retailing at US\$99.95, can change the channel of nearly any TV with an infrared remote sensor. Or how about a portable clock radio with a built-in color TV? The AV-100 runs on six "AA" batteries, and retails for \$299.95.

To keep its line of BOSS Organizers going, it's created a version for young girls called the "Secret Sender," which can also communicate by infrared or act as a TV remote. Where the BOSS offers calendaring functions, the "Secret Sender" has features which can tell fortunes or let girls draw pic-

tures of their special boyfriends. Don't laugh—it sold out at Christmas.

The BOSS, meanwhile, still costs just \$109.95 in the U.S., has 32K of memory for storing 1,370 phone numbers, and can operate in any of five European languages. There are also alarm, scheduling, and communication functions.

The niche Casio really dominates, however, is low-priced electronic keyboards. The latest model, the \$699 CTK-750, offers "magical presets," featuring things like break beats, arpeggios, and shadow drums, providing unique chord progressions and other sound combinations. A demonstration of the units, following a buffet dinner at the MGM Grand, showed them capable of serious music.

And, along with the usual batch of news releases, the press was also offered the new QA-100GY-S, a calculator which doubles as an alarm clock with a real clock face. ■

## CES Show Picks

Continued from page 61

ism of the sensation is almost spooky. Given the right application (shoot-em-up game are just a start) this device brings the "feelies" closer to our brave new world. One of the Disney staff tried it out just before I did. Now there's a group of creators that could make something truly great for the Interactor. I hope they do.

### Adult Education — Exploring Ancient Architecture

Publisher - Medio Multimedia Inc.  
Phone - 206-867-5500  
Cost - \$US59.95

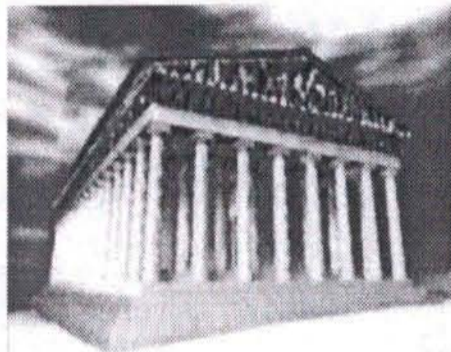

In grownup edutainment there are many good new titles from the likes of Time-Warner, Sony Interactive and World Library, (714)748-7197 (if you want classic books in CD format for reference).

My favorite title came from Medio Multimedia Inc. of Redmond, Wa. Their Exploring

Ancient Architecture is really a fascinating history lesson in the form of a tour through ancient structures. By the same folks who put out the JFK Assassination CD-ROM.

### Multimedia, Swiss Army style

Play 'em all, Sam - Pioneer Laseractive  
Distributor - Pioneer Electronics of Canada  
Toronto - 300 Allstate Parkway, Markham, ON  
Vancouver - 13911 Bridgeport Road, Richmond, B.C.

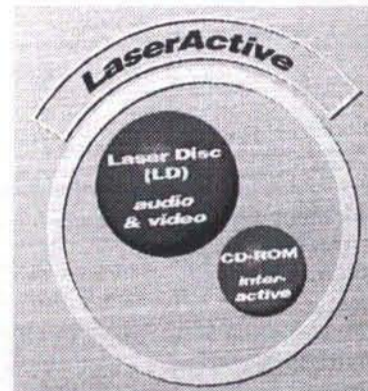

For the non-computer type there is Pioneer's Laseractive unit, a \$US400 player that can play all conventional CD, CDV, and LD formats plus the LaserActive format, a digital/audio hybrid that makes for some impressive interactive potential. The few titles on exhibit were among the best in the show, due largely to quality of the player. Plug-ins to allow the use of Mega-LD, LD-ROM2, Super CD-ROM, CD-G, Laser Karaoke, Sega, SegaCD, and SNES formats are available or are in the works. Given the broad range of formats this player can handle, plus the high quality video and sound it delivers, the Laseractive product should be a winner. ■

## X-10 HOME AUTOMATION

- CONTROLS LIGHTS, APPLIANCES AUTOMATICALLY/REMOTE
- UNITS PLUG INTO AC, NO-WIRING, \$10-\$90
- COMPUTER INTERFACES
- FULL LINE LEVITON
- ENERLOGIC ES-1400 CONTROLLERS
- SS5400 RF DOOR/WINDOW ALARMS

**BARAN-HARPER GROUP** X-10 DISTRIBUTORS  
416-294-6473 VOICE 416-471-6776 BBS



TELL ADVERTISERS  
YOU SAW THEIR  
AD IN



• 3 Year Parts and Labour Warranty

### IPC System Configuration

Intel Processor, 4 Meg Ram, 128K Cache, 1.2 & 1.44MB Floppy Drives, 245MB Hard Drive, SVGA Video 1MB VL & SVGA .28 Monitor, 101 Keyboard, VL Controller, DOS 6.2 & Windows 3.1, MS Mouse w/Pad, Free Tech Support. 3 VESA Local & 5 ISA Slots with Mini Tower Case.

### Limited Time Offer Special

#### 486DX-33 Mhz PCI Special !!

4 Meg Ram, 128K Cache, Pentium Ready, 1.44MB FD, 3PCI Slots, 5ISA Slots, 245MB Hard Drive, 1MB PCI Vesa Local Video Card, SVGA .28 Monitor, Microsoft Mouse, 101 Keyboard, DOS 6.2 & Windows 3.1

**\$2650.00**  
or 22.50 per week

3 Years Full Parts & Labour. One Year On-Site.

#### 486 CD FXis-33 Mhz Special !!

Intel 486SX-33MHz, 4 Meg Ram, 1.44MB FD, 120MB Hard Drive, VESA Local Video Card and Controller, SVGA .28 Monitor, Microsoft Mouse, 101 Keyboard, DOS 6.2 & Windows 3.1, Double Speed CD-ROM, Sound Card, Dual Speakers, CD Titles

**\$1999.00**  
or 17.40 per week

3 Years Full Parts & Labour.



486SX/33MHz  
**\$1599**  
or \$14 per Week

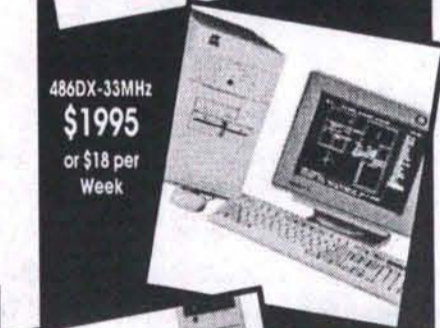

486DX-33MHz  
**\$1995**  
or \$18 per Week

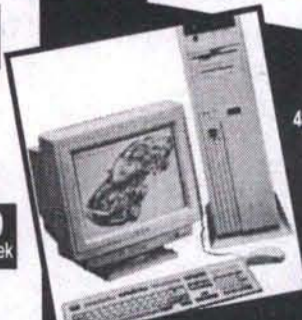

486DX2-66MHz  
**\$2399**  
or \$21 per Week

## Toronto's First and Best Personal Internet Connection



# Intermex Online

Only Intermex offers you inexpensive access to the Internet using powerful tools that let you access international people, data, and places easily and effectively.

Whether you are a researcher, an infomaniac, or just looking for something new and fun, we've got the right connections at the right price.

New to the Internet? You'll be able to easily talk to millions of people through mail or live, access huge amounts of news and data located on servers around the world, play games, and read and participate in worldwide discussion areas for the lowest cost -- monthly or yearly -- available anywhere.

- Telnet: Direct access to worldwide libraries, databases and other Internet connected sites
- FTP: Direct access to gigabytes of files including major archive sites, Microsoft, Novell, etc
- Gopher: Easy access to Internet resources
- IRC: Chat live with thousands worldwide
- Easy to use menus or full UNIX access with your own directory and powerful access tools
- Fast, reliable international Internet mail and over 7000 Usenet newsgroups

**Free Access Available!**

Flexible Account Configuration • Prices Low as \$5/Month • No Hourly Charges

Modem Lines (up to v32bis/14400) 416 363-3783 Call by Modem Today for  
Voice Info-Line 416 363-8676 Online Signup

**Call us and experience the world's largest, most powerful network!**

# HI-TECH SERVICES

835 ALBION RD., ETOBICOKE

MONDAY - FRIDAY • 10AM - 8PM  
SATURDAY • 11AM - 6PM

TEL: (416) 746-8815  
FAX: (416) 746-0415

# ScanPlus Color/Gray Scanners Porsche Engine at Low price! Ideal for OCR, DIM, OMR, FAX...

## World's #1 Plustek SheetFed Scanners

|                                     |        |
|-------------------------------------|--------|
| SP-600, 600/1200dpi Gray for PC     | \$549* |
| SP-6000, 600/1200dpi Color for PC   | \$719  |
| ADF 600G, 600dpi, Gray + PaperClip  | \$999  |
| ADF 6000C, 600dpi Color + PaperClip | \$1399 |

## Flatbed Scanners:

|                                |        |
|--------------------------------|--------|
| HP IIpb with OCR, 300dpi gray  | \$1199 |
| HP IIcx with OCR, 400dpi color | \$1599 |

## S/W for Plustek Scanners with purchase only

|  |                    |
|--|--------------------|
| WordScan OCR for Windows   | \$139 Listed \$399 |
| Recognita OCR for Windows  | \$199 Listed \$599 |
| Xformer Raster to Vector for DOS   | \$199 Listed \$499 |
| PhotoStacker image compression   | \$119 Listed \$199 |
| QuickPix Image Database for DOS  | \$129 Listed \$299 |
| Remark Office OMR Optical Mark Reading S/W for Survey, Research analysis | \$199 Listed \$599 |

\* limited quantity.

## ScanPlus Color 6000 for Apple MAC:

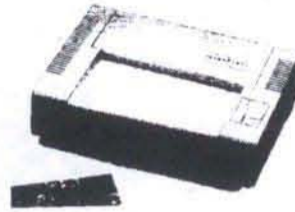

**SPECIAL**

**\$799**

- System 7.X compatible
- 24 bit one pass color scanner with SCSI
- 600dpi, 256 Grayscale, halftone, lineart
- plug in for Photoshop 2.5 included
- Calera WordScan for MAC included
- Colorit Image Editing for MAC Add \$99
- Can be used on PC, need SCSI adapter

**中文電腦系統 Chinese Computer**  
 精品手寫系統 只佔3K記憶體, DOS或C- Windows \$449  
 九三年科技大獎 保証比其它手寫系統優勝  
 歡迎參觀比較 各大機構及識貨用戶之首選  
 飛羚中文系統(試用版)特價 \$20 (雷射OA版) \$138  
 方玲藏珠字庫(5款字體) DOS或中文 Windows \$349

## Computer Systems Special :(Intel CPU, DOS and Windows included)

|                   |               |  |
|-------------------|---------------|--|
| 486-DX 33 \$1,829 | DX-50 \$2,039 | DX2-66 \$2,079 (With Plustek Scanner purchase) |
| 486-DX 33 \$2,129 | DX-50 \$2,339 | DX2-66 \$2,379 (Without Scanner purchase)      |

VESA Local Bus Mainboard with 256KB Cache memory, 8MB Ram, 245MB Harddrive, 1.2 & 1.44MB Drives, 15" SuperVGA Non-Interlaced 0.28mm Monitor, 1MB VESA Local Bus Video Card, Local Bus IDE I/O Card (2S, 1P, 1G), 5 Bay Medium Tower Case, 101 Keyboard, 3 button Mouse.

### Scanner and Printer bundle for PC:

|                                    |         |
|------------------------------------|---------|
| Color 6000 scanner + Canon BJC-600 | \$1,399 |
| Color 6000 scanner + HP4P Laser    | \$1,899 |
| Color 6000 scanner + HP 1200C      | \$2,499 |

### Scanner & Fax/Modem bundle for PC:

|                                  |       |
|----------------------------------|-------|
| Color 6000 + Fax/Modem           | \$729 |
| Color 6000 + 14.4 Fax/Modem Int. | \$799 |
| Color 6000 + USR 14.4 Sport Int. | \$849 |

Scanners available from:

|          |          |          |          |             |           |           |          |           |          |          |
|----------|----------|----------|----------|-------------|-----------|-----------|----------|-----------|----------|----------|
| Toronto  | Brampton | Markham  | Whitby   | Scarborough | Brantford | Cambridge | London   | Kitchener | Ottawa   | Guelph   |
| 967-9333 | 451-6769 | 475-7570 | 430-8944 | 269-7777    | 753-5750  | 622-4957  | 679-2922 | 745-3218  | 834-7678 | 836-7754 |

Scanner Rental Gray \$49/wk, Color \$95/wk, ADF \$115/wk. Refurbish models available.

**PLUSTEK Canada Inc. Unit #5, 151 Brunel Rd, Mississauga**

**Tel:(905)890-9300 Fax:(905)890-9802**

All name mentioned are trademark of their respective holders

## Characteristics of Plustek Scanners:

1. HP ScanJet Series & TWAIN compatible
2. 1 pass color scanning (Faster than 3 passes)
3. 1/2 size, weight and price of Flatbed
4. More durable than flatbed (Less moving parts)
5. Input device for Fax/Modem (Better than fax machine)
6. Resolution up to 1200 dpi (With interpolation)
7. Scan Phonebook, Photograph & Photocopied materials
8. Create own flyers, brochures etc. (In House DTP)
9. Support WP, Image editing, OMR, DIM & DTP softwares
10. Support Systems: DOS, Windows, OS/2, MAC
11. Included HISCAN, save image as TIFF, PCX, BMP & TGA
12. Up to 2 years warranty and Technical Support

## Scanner Comparison:

### HandHeld

limited scanning width  
Susceptibility to human error  
High defective rate due to mishandling  
Cannot replace fax machine, copier

### Sheetfed

Affordable, easy to operate  
cannot scan book directly, copy needed. Can scan continuous page  
Can replace fax machine & copier

### Flatbed

Not Cost effective, difficult to align  
Can scan book but will distort binding area  
Scanning length is fixed, large footprint  
For professional graphic artist.

**總代理: 百事達中文電腦**  
 電話: (九零五)八九零八零八八  
 產品繁多, 不能盡錄, 歡迎查詢  
 傳真: (九零五)八九零九八零二  
 二神中文排版, WYSIWYG \$249 天蠟星文書 \$69  
 雅品美工簡報系統 (點陣版) \$89 (專業版) \$999  
 新柏泰專業排版 HP 3000/6000版, 公認排版至尊 \$3389

**TAXES MADE EASY**

Prepare your 1993 income tax return the easy way.  
Use TaxSpread templates with your spreadsheet.  
No learning and no more calculations!  
Fill in the numbers on your tax return - examine results,  
do "what-ifs", revise as necessary.  
Provincial tax and tax credits form, Schedules 1 to 9 and charts included.  
Available in WK1 file format, complete with instructions.  
Send cheque/money order for \$9.95 to:  
Alitz Group Inc.  
Suite 230, 1100 - 8 Avenue S.W., Calgary Alberta T2P 3T9  
Specify Province and Disk Size

**APix Tel: (416) 750-9909****AMIGA Products**

• Picasso II RTG .....\$639  
• Spectrum EGS .....\$639  
• Piccolo.....\$730  
• Wavetools 16bit Sound card .....\$469

**IBM Products**

• 486DX-33 Complete system .....\$1825

\*\*Call for prices on other products\*\*

Computer/Fax  
Sales • Rental • Lease

**ABS Group**  
The Computer People  
In business since 1971

Special!! Inkjet Printers \$249  
(416) 636-2571

TELL ADVERTISERS YOU  
SAW THEIR AD IN

CANADA'S COMPUTER INFORMATION SOURCE  
**COMPUTER PAPER**  
NEWS REVIEWS FEATURES

**gamereview****3-D Dinosaur Adventure**

BY GRAEME BENNETT

From: Knowledge Adventure, 818-542-4200.  
Price: US\$79.95

Summary: Multimedia dino park with 3-D  
"virtual reality" effects, full-motion  
video and stereo sound. 3-D glasses is  
included.

Media: CD-ROM (a floppy-disk version is also  
available for US\$59.95)

I first found Dinosaur Heaven in Drumheller, AB. Located there, of course, is a famous dinosaur museum, and I was the number one dinosaur fanatic of my generation.

I, like most children, wanted to know everything about dinosaurs and had studied and saved what seemed to be every scrap of dinosaur info on earth. When I got to the park, where they had life-size (!) painted statues of the terrible lizards, I rocketed past some guy who was trying to pronounce the strange animal names on the plaques for his family, and started shouting, "Ooh, there's a Brachiosaurus! There's a Triceratops!" I couldn't even read.

Well, Knowledge Adventure has just released a CD-ROM for people like me, or maybe our kids. It's a virtual-reality dinosaur

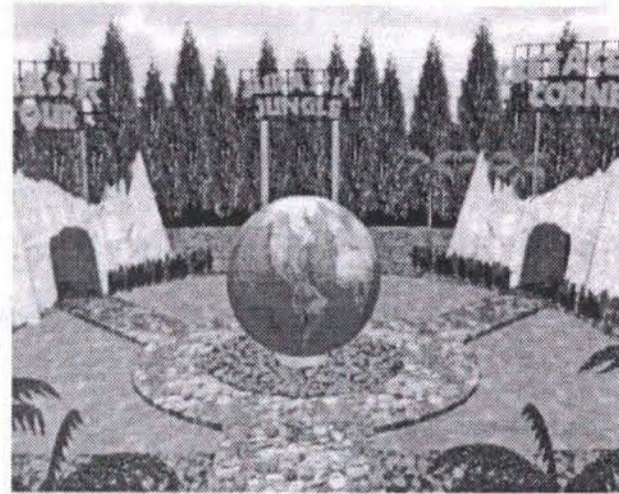

park of your very own. So put on your 3-D glasses and let's take a tour.

The first treat is the opening animation: a way cool Tyrannosaurus Rex in 3-D, with sound effects and music. Roar!

This leads to a main menu that bears more than a passing resemblance to the main gate in the movie Jurassic Park (no coincidence, I'm sure). Everything here is modeled in 3-D, and with the mouse or keyboard, you can follow paths into Triassic World, Jurassic Jungle or Cretaceous Corner. Each area has unique features.

You'll need those 3-D glasses (An extra pair is included) in the Triassic Tour, for a virtual-reality animated walk-through of the dino museum. Basically, you can walk anywhere you like (in a first-person point-of-view) and it's all in 3-D. Interestingly, the patent-pending 3-D effects are in full-color, unlike most red-and-blue 3-D images I've seen.

The Jurassic Jungle has a movie theater with 30 movies (six in the disk version). All feature digitized sound effects and a musical score. They range from fairly bogus to grippingly real (check out The Chase or Death of the Dinosaurs).

Another fun example of creative play is "Create-a-saurus," where you apply various kinds of "skin" to wireframe dinosaurs. Several texture maps and surface attributes are available, including wood paneling, zebra-skin, checkerboard, marble and several others. It's just the thing if you've ever dreamed of having your own gold-plated Stegosaurus. Like virtually everything else in the program, the 3-D models can be viewed from various angles.

Like the Triassic Tour and Jurassic Jungle, Cretaceous Corner has several activities I haven't room to mention here, but the Save The Dinosaurs game is worth mentioning. It is a 3-D maze game where you must avoid giant bugs, hostile carnivores, find your way out of the "time tunnel" into the correct time period, and then find the right dinosaurs before a comet strikes the earth and wipes them all out. Needless to say, it's not that easy.

**Memory Problems**

The main problem with this game is a technical one, largely due to the feeble memory

limitations of DOS. The game requires 520K and a mouse driver other than the one built into Windows.

Being a CD-ROM, of course, it also requires that CD-ROM drivers and MSCDEX (the code that assigns a drive letter to the CD-ROM drive) be active. The program doesn't appear to tolerate low-memory situations very well, and acted erratically, skipping sound effects and occasionally locking up until we removed all non-

essential AUTOEXEC.BAT commands. On our system, this required that we build a separate AUTOEXEC.BAT file. We called ours DINO.BAT. It looks like this:

```
ECHO OFF
C:TSCSI\MSCDEX /D: TSLCD /M:10
PROMPT$P$G
PATH C:\;C:\DOS
C:\MOUSE\HMOUSE
CD C:\DINO3D
DINO3D
```

A file like this can be created with the EDIT program that comes with MS-DOS. (Note that your CD-ROM drive and/or mouse may use different command-names. The ones shown here are for our Trantor SCSI adaptor and Honeywell Mouse.)

When we want to play the game, we have to abort the execution of the regular AUTOEXEC.BAT file (holding Control-C while starting up will interrupt it). Then, we type DINO.

Adding the ability to launch the program from within Microsoft Windows proved problematic. Despite the fact that the box assures us that the product works with DOS or Windows, we found that running 3-D Dinosaur Adventure from Windows resulted in no digitized sound effects or speech. (you should hear the words "Welcome to 3-D Dinosaur Adventure" at the very first screen).

**Conclusion**

It passed the all-important "kid test." My 10-year-old daughter Emma gave it the thumbs up, calling it "pretty cool." If your kids don't agree, the company offers a full exchange-or-refund guarantee.

3-D Dinosaur Adventure brought productivity in our office to a standstill, as everyone stopped to marvel at the sound effects, movies and 3-D animations. It could be better in places, I suppose, but overall, it's pretty darn nifty.

And besides, you can't help but feel better, looking at the world through rose- and blue-colored glasses. If there's a kid in your house, or in your heart, don't miss 3-D Dinosaur Adventure. ■

**Try Paymate®**

Payroll you can learn and use in less than one hour.

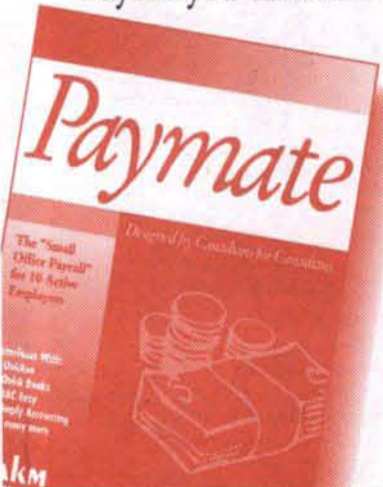

Run your own 1994 payroll for 90 days at no cost or obligation. If you like Paymate, simply load your full Paymate version and continue using your data. This free trial disc makes it simple for you to get the payroll software, designed by Canadians for Canadians, that sets the industry standards.

- Interfaces with most popular accounting software from ACCPAC to NEWVIEWS to QUICKEN, and many more. Call us.
- With 1994 Tax Tables and national TOLL FREE support.
- Get your FREE trial or full Paymate version from your dealer or accountant. For a dealer near you call us.
- Dealers! Inquire about our reseller program.
- "Paymate plus is one of the most flexible and easy to use products I have reviewed."

The Computer Paper Dec '93

**Paymate has a version to suit 2 or 2000 employees**

Paymate Plus For unlimited sophisticated payrolls.  
Paymate 20 A comprehensive payroll for 20 active employees.  
Paymate Simple The Small Office Payroll for 10 active employees.

**Fax now & get your free 90-day trial Paymate.**

Are you a Reseller?  yes  no  
Company: \_\_\_\_\_ Contact: \_\_\_\_\_  
Address: \_\_\_\_\_  
City: \_\_\_\_\_ Phone: \_\_\_\_\_ # of Employees \_\_\_\_\_  
Code: \_\_\_\_\_ Fax: \_\_\_\_\_ Disc size 525"  3.5"

**akm** 80 Fulton Way, Suite 201, Richmond Hill, On L4B 1J5  
Phone 905-771-1155 Fax 905-771-1344

**Fax Toll Free 1-800-263-3795**

# bookreview

## Updated Dictionary Explains New Terms

BY CHRIS METTEN

**Title:** *Computer Dictionary*,  
Second Edition 1994  
**Publisher:** Microsoft Press, Redmond, WA.  
**Price:** C\$26.95.

For some time, I have been looking for a dictionary of computer terms, but none contained the many new words and acronyms that have joined the English language in the last few years. Microsoft Press has just answered this need with the second edition of its *\*Computer Dictionary\**. It has been completely revised and updated, with many new definitions and illustrations.

The most remarkable feature of this dictionary is the depth of the explanations. Instead of just a brief definition, the purpose and how it works is described for each hardware component, in plain, easily understood, English. Software and communications concepts are described with similar clarity. Some definitions are accompanied by drawings, photographs, or diagrams.

Subjects covered include: memory management, desktop publishing, computer industry slang, applications, programming, data storage, hardware, printing, networks,

graphics, electronics, systems software, and communications. There are many cross-references leading the reader to related topics.

Appendices contain the following tables:

- ASCII Character Set, showing decimal and hexadecimal equivalents.
- The IBM Extended Character Set, with decimal and hex equivalents.
- The Apple Macintosh Extended Character Set, showing characters and symbols (for ASCII characters 128 to 255) in Times, Geneva, New York, Courier, Zapf Dingbats and Symbol, fonts.
- The EBCDIC Character Set, with decimal and hex equivalents and meanings.
- Numeric equivalents for numbers in decimal (base 10), Hexadecimal (base 16), Octal (base 8), and binary (base 2). These equivalents can be very useful and are often hard to find when you need them.

The book contains 442 pages and measures 9" h" x 7 1/2". I recommend it as an addition to every collection of computer reference manuals. ■

Chris Metten is a Vancouver-based technical writer.

## This Old PC

BY KEITH SCHENGILI-ROBERTS

**Title:** This Old PC  
**Author:** Dale Lewallen  
**Publisher:** Ziff-Davis Press  
**Price:** \$41.95  
**Softcover** 608 pages 1993  
Comes with one 5.25" high-density diskette

In the ever-changing world of the computer industry, there's one constant: people generally want the latest and fastest machines possible. Problem is, most people have already invested in a computer system which is slowly becoming obsolete, but don't want to throw it all when considering an upgrade. That's where this book comes in, telling you what you do to salvage your old PC.

The nice thing about this book is that it is designed for people who want to upgrade their system, but don't necessarily know what part or parts needed or why. So while you may have been thinking of getting yourself a faster, bigger hard-drive to speed up your DOS spreadsheet program, this book will rightly tell you that what you really should upgrade is your CPU and memory, (because DOS spreadsheet programs do not use your hard-drive intensively, and are cal-

culated by the CPU directly using a computer's RAM). There are other books available on this subject, but they are not all aimed at the novice computer upgrader. *This Old PC* comes with a single 5.25" diskette with several programs that will help you determine the current state of your computer to help you determine what should be upgraded, and a few utilities designed to increase system performance.

*This Old PC* tries to be thorough, covering everything from things like basic memory upgrades to turning your PC into a multimedia computer. There are also sections covering the latest technology, like how to install Pentium and OverDrive chips, Bernoulli drives, and magneto-optical drives. There are a couple of drawbacks however: it often specifies brand name items when others would do just as well, and often does not give you much of an idea on how or why you should configure your software to match the hardware you have just installed.

If you are looking to improve your old system, willing to take a hands-on approach to the problem, but don't necessarily know where to start, consider getting this book. ■

Contact: Copp Clark Pitman Ltd. (416) 238-6074

## GET ON-LINE

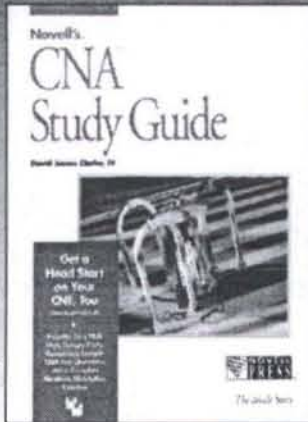

**CNA STUDY GUIDE**  
Novell

Novell's CNA Study Guide is for individuals who want to become Certified NetWare Administrators. Written by a Certified NetWare Instructor, this book covers all aspects of NetWare 2.2 and 3.11 CNA program - as well as most of the Certified NetWare Engineer (CNE) program. This is the only book of its kind!

0-7821-1139-4 Paper \$69.95

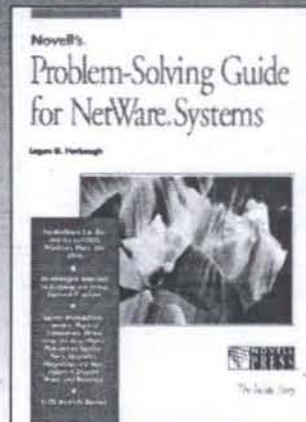

**PROBLEM-SOLVING GUIDE FOR NETWARE SYSTEMS**  
Novell

Novell's Problem-Solving Guide for NetWare Systems takes a systematic approach to finding and fixing problems anywhere on your network. Covering NetWare versions 2.x, 3.x, and 4.x, this book gives you the skills you need.

0-7821-1124-6 Paper \$39.95

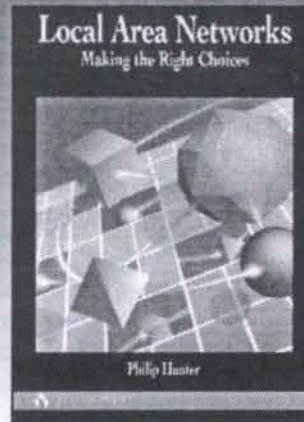

**LOCAL AREA NETWORKS**  
Making The Right Choices

If you're planning to install a local area network, or upgrade or expand an existing one, this non-technical guide will help you identify key factors to consider in the selection of each component.

0-201-62763-9 Paper \$42.95



**THE ONLINE USER'S ENCYCLOPEDIA**  
Bulletin Boards and Beyond

At last, a comprehensive look at the world of on-line resources. Learn to choose and use a bulletin board system and discover how to get the most out of global networks.

0-201-62214-9 Paper \$42.95

### TORONTO COMPUTER BOOKS

521 Yonge Street  
Toronto, Ontario  
M4Y 1Y4

Tel: (416) 925-2088  
Fax: (416) 925-3471  
E-Mail Address tcb@io.org

### NORTH YORK COMPUTER BOOKS

35-4841 Yonge Street  
North York, Ontario  
M2N 5X2

Tel: (416) 226-9989  
Fax: (416) 226-6212

### WATERLOO COMPUTER BOOKS

1 King Street North  
Waterloo, Ontario  
N2J 2W6

Tel: (519) 746-6042  
Fax: (519) 746-6863

### MISSISSAUGA COMPUTER BOOKS

1706 Dundas Street East  
Mississauga, Ontario  
L4X 1L7

Tel: (905) 279-6055  
Fax: (905) 279-6239

## bookreview

## Protecting Your Computer Against 'Attacks'

BY KEITH SCHENGILI-ROBERTS

**Title:** Computer Security Basics  
**Author:** Deborah Russell and G.T. Gangemi Sr.  
**Publisher:** O'Reilly and Associates

**Price:** \$29.95 U.S.  
 Softcover 448 pages 1992

In the past few years there has been a lot of concern in the computing community about unwanted intrusions and tampering

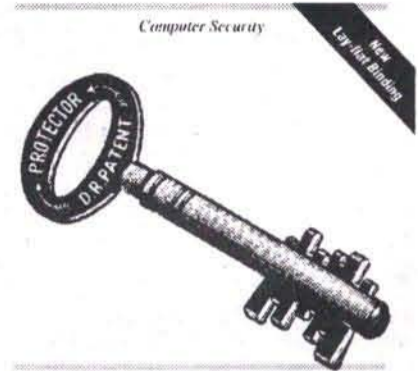
COMPUTER  
SECURITY  
BASICS

Deborah Russell and G. T. Gangemi Sr.  
 O'Reilly & Associates, Inc.

by malicious hackers. You only have to remember cases like the East German hackers breaking into American military databases (as portrayed in Clifford Stoll's \*The Cuckoo's Egg\*), or the scare over the Internet Worm a couple of years ago to be reminded about the serious nature of computer crime.

But the type of computer crime that reaches the headlines are only the tip of the iceberg. Most computer security problems never reach the newspapers, because admitting that a computing system is insecure can lay businesses open to financial ruin. Also most computer crimes are done by insiders who have ready access to data and computer systems. Proper computer security means taking care of internal as well as external computer security. That's where this book comes in.

If you're in charge of securing a computer system and are not already paranoid, you probably will be after reading this book. It lays out the types of "attacks" you can come to expect, and what you can do to guard against them. The book goes into enough detail to give you an idea of what you're up against, but not enough to become a "how to" book for malevolent hackers. It covers the basics of how to take preventative measures on your systems, from login procedures to data audits, encryption standards and determining who should have access to data.

It also devotes a chapter to "Viruses and Other Wildlife", looking at the common ways and tools hackers use to break into systems. It is probably the only book readily available on the security systems used by U.S. and Canadian governments. In fact it spends far too much time in this area, but it will prove to be interesting to those looking for standards on how to keep data from leaking outside of your computers.

Originally published in 1992, it is not right up to date with some of the newest developments, like the "clipper" chip (a U.S. government initiative that would allow Federal officials to "listen in" on all encrypted transmissions), but will provide the user with many tips on how to keep hackers out of their computers. ■

Contact: O'Reilly and Associates 1-800-998-9938 or Internet address: [order@ora.com](mailto:order@ora.com)

We just made visiting  
 our computer book section  
 up to 14400 BPS faster.

Introducing the  
 World's Biggest Bookstore BBS.

All you need is a love for computer books and a modem. The all-new World's Biggest Bookstore Bulletin Board System lets you shop online for the computer books you want, when you want, at Toronto's biggest computer book retailer. And do it all from the convenience of your office or home.

Enjoy Forums sponsored by leading edge companies like QUE, Microsoft, IDG, Ziff Davis and many more. Check out our Special Interest Forums devoted to major applications and subject areas. Take part in online round table "chats" with well-known computer authors and personalities. And have some fun—on us. Because the **WBB BBS is free\***. That's right, no connection or user fees.

So log on soon.  
 We'd love you to visit.

Coming online December 1, 1993.  
 World's Biggest Bookstore BBS

**(416) 240-8056**

\* Some advanced features require credits accumulated via the online shopping system.

WBB  BBS

The World's Biggest Bookstore  
 20 Edward Street, Toronto, Ontario M5G 1C9. Tel: (416) 977-7009 Fax: (416) 977-3728

# Wow: Basic Help For Photoshop

BY KEITH SCHENGILI-ROBERTS

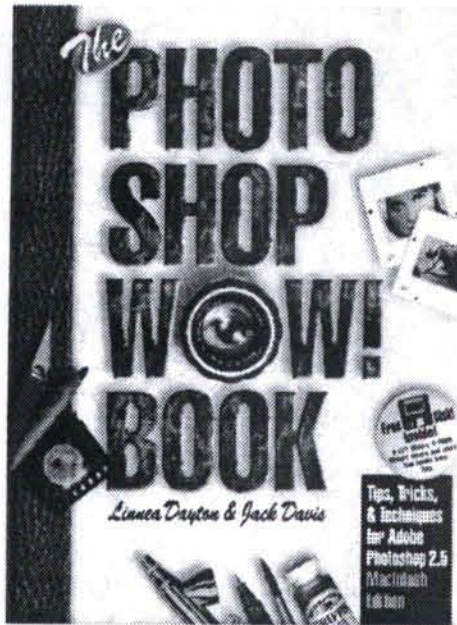

It is filled with useful information. It starts out with the basics like the memory requirement for your Mac, and continues into more complex issues like how Photoshop actually handles color images. Further chapters step you through the use of masks and channels, how to enhance photos, use filters, and do effective montages. The book also shows you how to paint with Photoshop, use special effects in your images and how to add depth and motion to your compositions. In each case the steps needed to create an effect are detailed, usually accompanied by pictures illustrating each step in the process.

One thing this book does not lack is pictures. This book is filled with them, many done by professionals and artists who work with Photoshop all the time and know how to put it through its paces. And for once, the text does not take a back seat to the pictures as the text is well-written and concise. The book is punctuated with helpful hints and tips on how to get the most out of the program.

The diskette that comes with the book contains a few useful supplementary programs to Photoshop, including extra filters, a "slide-show" program, and several other useful utilities.

Whether you are looking to create an ad, touch-up photographs or create fantasy worlds on your Mac, consider getting this book. It will help you to get professional-quality images while using Photoshop. ■

**Title:** *The Photoshop Wow! Book: Tips, Tricks, & Techniques for Adobe Photoshop 2.5 Macintosh Edition*  
**Author:** Linnea Dayton & Jack Davis  
**Publisher:** Peachpit Press Inc.  
**Price:** \$49.00. Softcover 196 pages 1993  
 Comes with one 3.5" diskette

Adobe's Photoshop 2.5 for the Macintosh is one of the most powerful image editing programs around. This also means that for many people, it is one of the hardest to master. This book is a good introduction to what can be accomplished with the program and will also serve as a good reference for experienced users.

**TECHNICAL BOOKSTORE**  
 Engineering, Environmental, Construction, Electronics, Telecommunications, C/C++, and Manufacturing Books, plus Engineering Training Videos, and Software. ISO 9000 Video Available! Books for Students & Professionals. **Lowest Prices in Canada!** Call 624-1058 for a Free Catalogue or Visit Canadian Professional Information Centre 4580 Fieldgate Drive #11, Mississauga (Eglinton & Dixie)

**COMPUTER BOOK STORE**  
 Tel/Mail/Fax Orders Welcomed  
*Same Day Shipping*  
 Computer Magazines  
  
 2019 Bishop Street  
 Montréal, Que. H3G 2E8  
 Tel: 514-287-1863  
 Fax: 514-287-7556  
*The Professional's Choice*

**BOOKS**  
 • Visual C++  
 • Turbo C++  
 • Visual BASIC 3.0  
 • Paradox  
 • CorelDRAW  
 • PageMaker  
 • AutoCAD  
 • Whole Internet

**Computer & Book CENTRE**  
 Computer Books, Magazines & Accessories  
 Telephone: (905) 279-9968 • Fax: (905) 279-8101  
 325 Central Parkway W., Miss., Ont.  
 Confederation & Cntrl. Pkwy., near Square One

**MAGAZINES**  
 Internet World  
 Boardwatch  
 BBS Magazine  
 Online Access  
 NetWare  
 Corel  
 Publish!  
 CADalyst

**Power of Choice**  
**NEC SuperScript 610 Windows Based Printer**  
 - 6 ppm speed, 300dpi Sharp Edge Technology  
 - Up to 3 times faster than competitive lasers  
 - Host based/Windows driven  
 - Animated on screen printer status  
 - 20 True Type fonts included  
 - EPA Energy Star compliant  
 - 2 year overnight replacement warranty  
**\$788\***  
 \*Please present this advt. to get this promo price. Terms: Cash/Cheque w/D  
**Compatibles Plus**  
 Ph: (416) 487-5050 Fax: (416) 487-5579  
 138 Redpath Ave., Toronto ON M4P 2K4

**Micro Computer HARDWARE Directory**  
 2,430 Listings  
**CONTACTS YOU NEED (Buyers & Sellers)**  
**(416) 819-1274**

# The Computer Book Clearance Centre

## 50%-80% Discounts on Selected Titles

- New titles every week
- Mail and special order by phone

*"Specialists in computer books for beginning users, consultants and programmers."*

Open Monday through Saturday 10:00 AM to 6:00 PM

MISSISSAUGA  
**COMPUTER BOOKS**

1706 Dundas Street East  
 Mississauga, ON L4X 1L7

Tel: (905) 279-6055 Fax: (905) 279-6239

**COMPUTER BOOK CLEARANCE**  
**45 TO 90% OFF** Computer Books  
 Special Fix Your Own PC 2nd. Ed. Suggested Retail \$39.99 Sale \$14.99  
 Shop At Any of These Locations!

|   |   |
|---|---|
| <b>PC Depot</b><br>3145-14th Ave. Markham, Ont.<br>470-2211<br>                                  | <b>A Plus Software</b><br>332 Main St. N. Brampton, Ont.<br>450-1234<br>                     |
| <b>T&amp;P Video Games &amp; Computers</b><br>Square One Mall Mississauga, Ont.<br>897-1271<br>  | <b>A Plus Software</b><br>589 Fairway Rd. S. #7 Kitchener, Ont.<br>895-2586<br>              |
| <b>T &amp; P Video Games &amp; Computers</b><br>Maple View Mall Burlington, Ont.<br>681-7320<br> | <b>Twinstar Computer</b><br>35 Harvard Rd. Campus Estates Plaza Guelph, Ont.<br>837-0561<br> |
| <b>OTA Notebook Centre</b><br>343 College St. Toronto, Ont.<br>921-1177<br>                      | <b>Clearance Warehouse</b><br>4496 Chesswood Dr. Unit 13 Downsview, Ont.<br>398-3337<br>     |

**SAVE ALL YEAR!! ALWAYS CLEARANCE!!**

## Power Windows Online System

### BBS FEATURES:

- First Totally Windows Driven BBS
- Friendly/Professional Sysop
- Simple To Use
- Multi-User Chat
- All Lines 14.4 K
- 8 Lines So Far
- Download In Background
- Apogee Conference Online
- Online Sports Pools
- Expert Proline & Sports Predictions

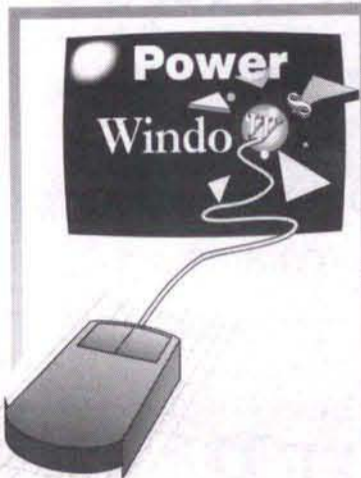

Working in Windows  
CALL FOR A FREE DEMO

969-8269

# commtalk

BY JAMES MACFARLANE

## Checking Out The Musical Underground, Internet Style



An organization called the Internet Underground Music Archive (IUMA) is the closest thing to a pirate radio station I've ever seen. Like real pirate radio stations they give airplay to bands that would otherwise rarely get on the air. But the music they have in their library doesn't go on the radio, instead it's downloaded by users via the Internet.

IUMA provides an alternative marketing channel to small bands. It will create a downloadable information kit of the band, including a text file with biography and ordering information, a bitmap, which acts as the cover art, and up to five minutes of

digitized music. All songs are sampled with 64x oversampling -89dB SNR sound digitizer at 44.1kHz in stereo (that's true CD quality), then compressed from 13.7:1 to 6:1, depending on the original's audio quality, using the MPEG sound compression standard. According to IUMA, MPEG provides the best sound/size ratio. You need an MPEG sound player and the right hardware to play back the recordings.

IUMA is run by Jeff Patterson and Robert Lord of Santa Cruz, California. I caught up with them via Internet E-mail.

**The Computer Paper:** Can you give some background information about how the project got started and what kinds of bands are sending in material.

**IUMA:** The project got started when Rob found out about the MPEG encoder/decoder. It had always been a goal of his to somehow bring down the music industry as we know it, and this seemed like a good way to do it.

He mentioned MPEG encoding at the end of one of his letters to me, and I realized that with this compression method, I could put my band, the Ugly Mugs, on the net.

MPEG allowed us to compress audio to around 13.7:1 without much noticeable sound quality loss. At ratios of 6:1, there is no loss in quality.

So, I told him that I wanted to put my band on the net and start a standard for other bands to follow. He was thinking the same thing, only he had the idea to start an archive where bands could keep their music for people to retrieve. Thus, the IUMA was born.

So far, most of the bands are college bands that are playing shows in their local areas. There are a few exceptions, though. Marguerite Conti is a new-style-folk singer who has two CD's out on her own label. She is helping us obtain many other musical styles as well. And the band Deth Specula are former SCO employees.

Most of the appeal seems to come from the college crowd, though. Their styles range from weird Zappa-esque music (Ugly Mugs) to bluegrass-grunge (Whistle Pigs) to hip-hop-folk (Brother Free). We are expecting the

THE INTERNATIONAL PROGRAMMERS  
**GUILD**  
Professional Programmers  
**REFERRAL SERVICE**  
Call (416)824-7947  
Canadian Chapter, 3016 Runcorn Row  
Mississauga, Ontario, L5N 4S5

## Top Quality Products at Low Discount Prices! Order Now! & SAVE!

### Sound Boards

Sound Blaster Deluxe ..... \$99  
Sound Blaster 16 Basic ..... \$189  
Sound Blaster 16 MultiCD ..... \$229  
Sound Blaster 16 SCSI-2 ..... \$259  
Sound Blaster 16 SCSI-2 ASP Special Wave Blaster (Hot Price) .... Special  
Turtle Beach MAUI (wavetab) \$239  
Pro Audio Studio 16 ..... \$289  
Pro Audio Studio 16XL ..... \$499

### FAST CD-ROM Drives

Panasonic CR-562B Internal Kit ..... \$299  
Texel DM-3028 335Kb (Hot Price) ..... \$429  
Texel DM-5028 335Kb SCSI-2 ..... \$599  
NEC CDR-38 MultiSpin (Ltd Qty) ..... \$365  
NEC CDR-400 3Xp Portable ..... \$599  
NEC CDR-500 3Xi Internal SCSI-2 .. \$629  
NEC CDR-600 3Xe External SCSI2 .. \$769  
Toshiba XM3401B Internal ..... \$499  
Toshiba XM3401E External ..... \$699  
Pioneer DRM-604X 612kb 6Disc Special

### High-Speed Video

Diamond Stealth 24 ISA/VL ..... \$219  
ATI Graphics Ultra Pro VLB 2MB .... \$419  
Diamond VIPER VESA/PCI ..... \$499/Call  
Cardinal WARPspeed 2MB ..... \$699  
MV Pro Graphics 1280 24bit ..... \$1079

### CD-ROM Bundles

#### DOS CD Bundle

- Grolier Multimedia Encyclopedia
- San Diego Zoo - The Animals
- Toolworks US & World Atlas
- The Secret Of Monkey Island
- Toolworks Reference Library

**\$109**

#### Windows CD Bundle

- Grolier Multimedia Encyclopedia
- San Diego Zoo - The Animals
- Toolworks US & World Atlas
- Mavis Beacon Typing Tutor
- Software Toolworks Chessmaster 3000

**\$129**

#### Other Best Selling CD Titles

MAYO Clinic Family Health Book ..... \$39  
SPORTS Illustrated Almanac MPC ..... \$72  
NEW! Grolier Multimedia Encyclopedia Rel 6.0 ..... \$299

### Cool February Deals

Prices Valid 'til Feb. 15

#### Creative Labs Wave Blaster

- Get Realistic Instruments Sounds Instead of FM Synthesis
- Includes 4MB of Sampled Sounds
- Uses True Synthesis WST Technology
- Presets: 120 Instruments, 18 drum kits & 50 sound effects
- Great For Business Presentations & Music Composition!

**\$262**

#### Media Vision Fusion DoubleCD 16

**\$689**

- Pro AudioSpectrum, award-winning 16-bit Stereo Sound
- 100% Sound Blaster and SCSI Compatible
- Double Speed WEC CD-ROM drive with SCSI interface
- Hardk Photo CD Multi-session Ready, EA Ready
- Amplified Stereo Speakers w/ Bass, Treble & Vol Control
- Includes: 7th Guests, Compaq Interactive Easy, & more
- Easy to Install - Toll free tech support 7days/week!

#### Sound Blaster 16 SCSI-2 ASP

- 16-bit, 44kHz Record and Playback
- Industry Standard SCSI-2 Interface
- High-Performance Advance Signal Processing (ASP)
- Voice Recognition, Grolier MM Encyclopedia & Microphone
- And Much Much More Included!

**\$299**

#### Don't Waste Your Sound Card On Inferior Speakers!

Everyone knows computer speakers are somewhat less high-tech. And your clock radio sounds better than most add-on speakers. So get the Award Winning Powered Partner 42 speakers from Acoustic Research. They're the highest fidelity speakers you can get with built-in amps for under \$300. The superior sound you'll get will be worthy of the sound card you invested in.

**\$259**

Prices Valid 'til Feb. 15

### Video Capture

Creative Video Blaster ..... \$439  
Video Spigot for Windows ..... \$447  
MV Pro Movie Studio ..... \$Low  
Intel Smart Video Recorder ..... \$697  
Cardinal SNAPplus ..... \$999

### BEST MM Speakers

(AR) Acoustic Research PP 22 ..... \$159  
AR Powered Partner 42 (Best Seller) Special  
AR Powered Partner 622 ..... \$379  
AR Powered Partner 570 ..... \$449

### Monitors

KDS 14" NI .28dp Overscan Screen \$349  
KDS 15" NI .28dp MPRII ..... \$539  
MAG MX15F LR 15" ..... \$699  
Mitsubishi Diamond Scan 17FS ..... \$1349  
SONY CPD-1730 .25dp 17" ..... \$1349  
Mitsubishi Diamond Scan 20" ..... \$2129

### Printers

Citizen 24pin 240cps Col-Upg ..... \$290  
HP DeskJet 1200C ..... \$1799  
TI MicroLaser Pro 600 P23 ..... \$1943  
CANON LBP430 Laser - HP 4L ..... \$799  
CANON BJ-230 11"x17" Fast ..... Special  
CANON BJC-600 Color ..... Special

### Scanners

Logitech ScanMan EasyTouch ..... \$279  
Logitech FotoMan ..... \$695  
HP ScanJet 11p w/Interface ..... \$965  
HP ScanJet 11CX w/Interface ..... \$1385  
MicroTek ScanMaker IIxe ..... \$1554

### 2xSpeed Bundles

Creative Labs OMNI CD ..... \$389  
Creative DIGITAL EDGE ..... \$899  
Creative Discovery CD 16 ..... \$589  
Creative Edutainment CD 16 .. \$669  
MV Fusion DoubleCD 16 ..... Special  
MV Pro 16 Multimedia Sys ... \$1099  
MV Pro 16 Multimedia II ..... \$1299  
Texel DM3028 Super Bundle ..... \$789  
Pioneer 4xSpeed Bundle ..... \$1818  
NEC 3xSpeed Bundle ..... \$999

### Controllers

Adaptec 1510 w/Software+Cables . \$119  
Adaptec 1542C w/Software+Cab. ... \$339  
Parallel-To-SCSI Adapter ..... \$136  
Adaptec T130 SCSI Controller ..... \$79

### Cables/Accessories

Creative labs MIDI Cable ..... \$39  
CD-ROM Audio Cables (any) ..... \$19  
CD-ROM Caddies ..... \$6.90  
Sound Blaster ASP Upgrade Chip ..... \$89

### Need Information? Call Us. We will be happy to FAX or Mail Information to you upon request.

#### Modems

BOCA Research 14.4k Data/Fax Ext ... \$245  
Intel 14.4Kbps w/Fax Int/Ext ... \$229/245  
Practical Peripheral 14.4k D/Fax Ext ... \$289  
XyZel 1496E Voice/Data/Fax Ext ... \$449

#### PCMCIA Modems

Hoyes PCMCIA-2 14.4 Data/Fax ..... \$391  
Megahertz PCMCIA-2 14.4 Data/Fax ..... \$395  
PractiCard 14.4 Data/Fax PCMCIA-2 . \$399  
Intel PCMCIA-2 14.4 Data/Fax ..... \$419  
ATI PCMCIA-2 14400 ETC-Express Fax \$433

#### BackUps / Floppies

Conner 250MB with Software+Tape .. \$199  
Conner 250MB External ..... \$449  
Colorado 2.4GB Internal kit ..... \$1399  
Panzonic 1.44MB Floppy Drives ..... \$49  
Teac/Canon Dual Floppy Drives ..... \$169

#### Software

Aldus PageMaker 5.0 ..... \$679  
CorelDRAW! 4.0 w/2 CDs ..... \$269  
Corel Ventura 4.2 ..... \$239  
WordPerfect SIX.0 for Win ..... \$139  
IBM OS/2 2.1 for Windows on CD .. \$59.99  
Globalink Power Translator FRE/ENG \$239  
Microsoft Office 4.0 ..... \$599  
Microsoft Word for Windows 6.0 CU .. \$159  
Microsoft Mouse 2.0 & Windows 3.1 . \$169

#### Hard Drives

Quantum 270MB 12ms 128k IDE ..... \$319  
Quantum 345MB 12ms 128k IDE ..... \$375  
Quantum 525MB 10ms SCSI ..... \$739  
Quantum 540MB 12ms 128k IDE ..... \$739  
Quantum 1.05Gb 10ms 512k SCSI .. \$1199  
Conner 1.3GB 10ms 256k SCSI-2 ... \$1335  
Micropolis 3.022Gb Fast SCSI-2 .. \$2975

### OUR POLICY

At Multimedia Effects there are no minimum orders or unreasonable requests, we do not have any hidden charges or fees. We do not bill you until we ship your product. Corporate P.O.'s are welcome from qualified institutions. Shipping Cost to Quebec and Ontario ~ \$5.00. C.O.D. orders add \$5.00. Add 3% for credit card orders. We accept personal and company checks, but allow time to clear. For faster service send certified cheque, money order or bank draft. Mailing address: 49-6A The Donway West, Ste. 1011, North York, Ontario M3C 2E8. Please include daytime phone number. We will promptly replace any items but cannot guarantee compatibility. There is a 15% restocking fee on returned non-defective, un-opened goods returned within 30 days. We carry hundreds of computer/multimedia hardware and Software products, so please call us for items not listed. We offer all the latest products, in original packages with full manufacture documentation and warranties. Product prices & specifications are subject to change without notice. All trademarks and registered trademarks are of their respective companies.

WE WILL TRY TO MATCH OR BEAT ANY ADVERTISED PRICE. ALL PRODUCTS BRAND NEW & GUARANTEED. CANADIAN WARRANTIES ONLY.

**MULTIMEDIA EFFECTS**

AMERICAN EXPRESS Card    VISA    C.O.D.    MasterCard

Order-line **1-416-502-3942**  
Sales/Information **1-416-502-0404**  
24 Hr. FAX Order-line **1-416-502-1593**  
Monday-Friday 10:00am-6:30pm, Sat. 10am-6pm

Supporting Better Business through the Better Business Bureau

styles to become even more varied as this whole thing develops.

**TCP:** I know it's probably too early for this (IUMA went online in November 1993), but have you received any feedback from bands on the effectiveness of this distribution technique?

**IUMA:** The only band I can tell you about here is my own, the Ugly Mugs. So far, we've received about 10 responses from people all over the world. I expect that, right now, traffic through our site isn't extremely heavy, but it should pick up as MPEG players for other platforms are made available.

**TCP:** Could you give me some idea what the file sizes are for the sound files and entire packages (including bitmaps, etc.)

**IUMA:** The sound files run anywhere from 1MB to 5MB. The Whistle Pigs' "Trout", which is a short song recorded in mono, is only 1.2MB. If a song is in stereo, you can expect it to be twice the size of a mono recording. The pics are usually only 40-70K. So the entire package can be anywhere from 1MB to 5.5MB. This includes the song, a pic, and a text file about the artist. It safe to assume that the songs are usually around 2-3MB.

For compression, we use the MPEG audio compression algorithm. It is a more advanced way of compressing music because it takes into account psychoacoustics. Therefore, it can cut out information that your ear will never actually hear. It is the best audio compression method we have found so far.

**TCP:** Could you give some sources where people can obtain MPEG sound players.

**IUMA:** We are trying to keep all freeware and shareware encoders available at our site. So far, the only one we've actually received is from a company called Xing who makes a freeware player for Windows. Aware Corp. has Macintosh, SGI, and NeXT players, and we are still talking to them about shareware releases. For the Sun, we have found a few people working on their own MPEG decoders. Most notably, Tobias 'Doping' Bading from Germany is coming along pretty well.

**TCP:** What's the cultural significance of this technology? What is it doing for small independent artists and how will the mega-corporations react?

**IUMA:** Our aim, by using this technology, is to change music distribution as we know it. Even if IUMA doesn't accomplish this task, at least we are showing people that free distribution over long ranges without an actual material product is possible. We are showing that bands with little commercial appeal, and no money, can now reach thousands (actually, millions) of people who might be potential fans.

No longer is it solely up to the commercial industry to judge what kind of music people will hear. A band that never leaves their own garage can now have fans all over the world.

If someone likes one of these artists and wants to buy their CD or tape, all the money goes directly to the artist. There are no longer three or four different entities along the way who each take a chunk of the cash. Since we'll take any artist, the desire to make "commercial" music may die down.

We've heard that some of the industry giants want us out of the picture, which is understandable. If we introduce this con-

cept and it catches on, their whole industry would be obsolete. At least, that is what we are hoping.

**TCP:** Are you the first digital pirate radio station? Do you think of yourselves in this way?

**IUMA:** We're not really a "pirate" station. We are more of a digital public radio station. We'll have any group at all, and we are not involved in the transfer of money. But we're not really comparable to a radio station.

I guess we are more of a cross between a radio station, a label, a distributor, a music

store, and an art gallery. We don't really distribute, but we do make the songs available for people to come and get. Right now, I'm not sure how we would be classified. As far as I know, we are the first group to act as a distribution source for bands who don't already have albums out.

**TCP:** Is video next, especially with techniques like fractal compression on the brink of becoming affordable?

**IUMA:** This is up for debate. We were thinking that it might eventually come to that, but I think we'd rather just stick with

music. If we don't get into video, I'm sure somebody will. Right now, it is much easier for a band to record their music as opposed to a video. If we did have video, we wouldn't stop the music only archive. I imagine a video archive as a separate place altogether.

Also, in case you are interested, we will soon be linked to MTV.COM. Adam Curry, an MTV veejay, told us he wanted to link our site to his. So, when someone is using mosaic to peruse the net, there will be a place at MTV.COM where they can click and be transferred to IUMA. ■

**With 30 Million people on-line ... isn't it time you joined them?**

# GET ON-LINE TODAY

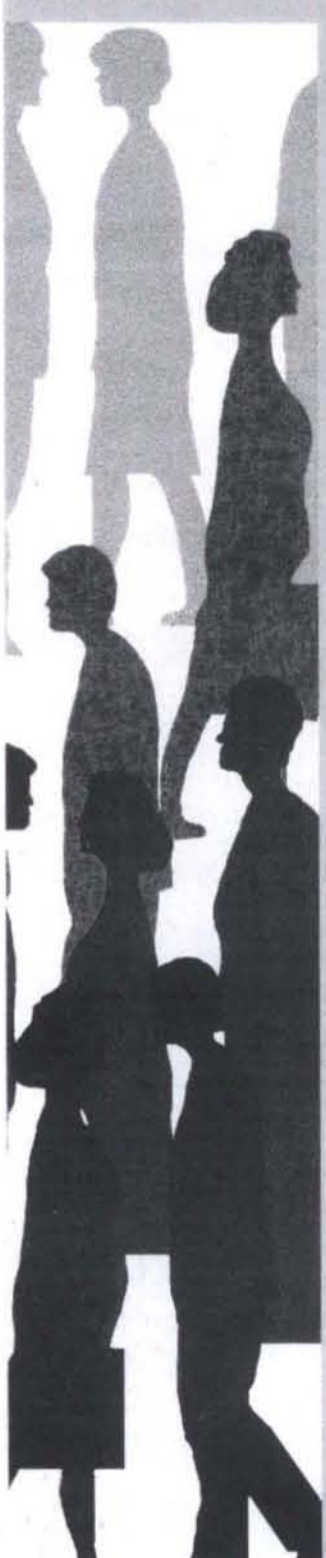

*Even if you haven't bought your modem yet, consider CRS Online's **BULLETIN BOARD** Service and call for our free information kit.*

**DISCOVER THOUSANDS OF FILES**  
The latest shareware releases and the largest on-line software collection anywhere. Don't pay for software on disks when you can get it for free as part of your subscription.

**6,000 PUBLIC CONFERENCES & INTERNATIONAL ELECTRONIC MAIL**  
Get information on thousands of topics from experts and hobbyists from around the world. Send messages person to person, around the world, for free as part of your subscription.

**LARGE LOCAL CALLING AREA**  
Free local calling from most of South-Central Ontario.

**FLAT ANNUAL FEE**  
Never pay by the minute or hour to use an on-line service again. Subscribers get 2 hours and 2 MB every day. Pay annually or in monthly installments.

**FREE TECHNICAL HELP**  
Phone support, seminars for new and advanced users and on-line help from CRS and thousands of computer users and software manufacturers.

**NEWS & INFORMATION SERVICES**  
Direct news feeds from Reuters & UPI and stock results from over 12 exchanges are low-cost extras.

ONLY: \$59<sup>95</sup> for a 3-month trial subscription,  
\$129<sup>95</sup> for your first year, or just  
\$12<sup>95</sup> per month  
(monthly subscriptions are for a minimum of 12 months.)

INTERNET  
ACCESS WITH EVERY  
SUBSCRIPTION

- your own Internet E-mail address (which is typically `firstname.lastname@canrem.com`)
- USENET newsgroups
- Internet mailing lists (listservs - available on request).

FTP/Telnet Special

(extra to the personal subscription)

\$25 = 25 hours/MB

Until February 28, 1994, all current and new CRS subscribers can purchase the extended Internet option (FTP/Telnet) for \$25. There will be no set-up charge and 25 hours of Telnet and/or 25 MB of FTP are included. (limit one per subscription)

Ping and Finger are included  
at no extra charge.

Call (416) 213-6000  
for more information or to sign up.

CRS ONLINE

12 Steinway Blvd., Unit 24, Etobicoke, ON M9W 6M5 • Phone: (416) 213-6000 • Toll Free: 1-800-563-2529

START GETTING THE MOST  
OUT OF YOUR MODEM.  
CALL AND SIGN UP TODAY:  
(416) 213-6000

CALL FOR OUR FREE INFORMATION  
PACKAGE...OR USE  
YOUR MODEM TO CALL  
(416) 213-6002 OR 213-6003  
FOR 60 MINUTES  
OF FREE ACCESS.

# Project Gutenberg: Electronic Texts for the Masses

BY KEITH SCHENGILI-ROBERTS

*Interested in reading some Shakespeare? Want to check-out the recent NAFTA Agreement for yourself? Or maybe you want to read some Mark Twain or H.G. Wells. If you have Internet access, you can get all of these titles (and more) in electronic format for free, courtesy of Project Gutenberg.*

Long a mainstay of the Internet, Project Gutenberg started back in December 1971 when student Michael Hart was given a \$100,000,000 account on a mainframe computer at a local university. The amount was not unusual at the time, and was the equivalent of an unlimited account, but Mr. Hart wanted to "earn" the amount that had been entrusted to him by paying it back in some way.

He then hit upon an idea well ahead of its time: computers used not merely to crunch numbers and perform operations, but also as depositories of information. The computer would act like the electronic equivalent of a library, except that you never had to return your copy of the book, and could easily copy it and pass it along to others yourself (an aspect of E-text Mr. Hart now likes to call "replicator technology").

Following up on this idea, Mr. Hart proceeded to type out the text of American Decla-

ration of Independence on the University mainframe, and made it freely available to anybody who had access to that computer — either directly or through the ARPANET (as the Internet was called at the time).

Since then the Gutenberg Project (named after Johannes Gutenberg, the man who invented the printing press) has celebrated the release of its 100th E-text with the publication of the complete Works of Shakespeare. The goal of Project Gutenberg is an ambitious one: to give away one trillion E-texts By December 31, 2001. This may seem far-fetched, but given the current expansion of the Internet it is quite possible that if each of their current titles gets to 100 million people by the year 2001 they will have distributed over 10 billion E-texts.

Many different E-texts are available through the project. Many are literary classics, such as *Tom Sawyer* by Mark Twain, *Paradise Lost* by John Milton, and *Alice in Wonderland*

by Lewis Carroll. The project also releases non literary titles such as the *CIA World Factbook*, the King James' version of *The Bible*, and *The Communist Manifesto*.

Project Gutenberg offers a number of "classic" books about the Internet and computing, including *Zen and the Art of the Internet*, *The Hitchhiker's Guide to the Internet*, *The Hacker's Dictionary of Computer Jargon*, and *Surfing the Internet*. These and many other titles are available to anybody who has access to the Internet.

The Works of Shakespeare were intended to be among the first additions to the E-text collection of the project when its electronic publication was halted by copyright restrictions. This continues to be the bane of the project, as copyright in the U.S. currently extends to 50 years after the death of the author.

Copyright laws in other countries often prevent E-texts produced by the project from being released outside the United States. The bulk of the project's titles is therefore works from the turn of this century, plus works in the public domain and titles donated freely to the project. Copyright remains a sore point with Prof. Hart, as each new E-text release has to be thoroughly checked to ensure that it will not conflict with any outstanding copyright restrictions. In the end it is the legal staff behind the project who determine which books can and cannot be distributed electronically.

The work of many volunteers goes into this project, not the least of which is the work of Prof. Michael Hart himself. In 1989, in recognition of his efforts, Mr. Hart was made Professor of Electronic Texts at Benedictine College in Illinois. Prof. Hart has put considerable personal effort and money into the project, and he says that only now has he "finally stopped the negative cash flow."

The Works of Shakespeare were underwritten by World Library, who distribute Gutenberg E-texts and other works on CD-ROM. The Gutenberg Project has been joined by other organizations with the same goal of distributing E-texts, including Internet Wiretap, the Oxford Text Archives and the Online

Book Initiative.

Prof. Hart has seen the Internet grow into a mature organization over the years. In an interview he said that for the first 17 years nobody was interested in the project. He first noticed a change in 1988, which for him was the year the Internet stopped being a "boring place filled with Unix hackers" to a place where there were enough people (a half-million at the time) on the Internet so that there was always somebody out there who would share the same interests as you. Prof. Hart predicts that 1994 will be the year of the Internet, and hopes to have 200 E-texts published by Thanksgiving Day 1994.

So what do you do with all of these E-texts? Most people think it is absurd to read books on a computer, but think nothing of reading endless E-mail messages. Probably the most significant aspect is how E-text may affect education in the future. Currently students are forced to take

what Prof. Hart calls a 'Trivial Pursuit' method, towards study, where they have to wade through endless aisles of books to find enough information to write essays about. In the end most of their time has been put into the search for knowledge instead of thinking about it.

E-text has the potential to free students from wasting time searching for knowledge through libraries when they can search for it on their computers instead. The computer can be given the duty of searching for relevant information, allowing the student more time actually learn from the object of the study.

Until that time comes, Prof. Hart and the volunteers at the Gutenberg Project will continue producing E-texts in their efforts to promote education and literacy. It is hard to estimate the value of their work, but it is safe to say that Prof. Hart has more than paid back the amount given to him in that mainframe account back in 1971. The potential value of these E-texts as they are used by thousands or millions of people over the years is inestimable. As Prof. Hart said in a recent message asking for volunteers, where else can you "Make \$100,000,000 in your spare time?" ■

**The goal of Project Gutenberg is an ambitious one: to give away one trillion E-texts by December 31, 2001. This may seem far-fetched, but given the current expansion of the Internet it is quite possible**

## QUALITY + LOW PRICES = GREAT VALUE

Upgrade your PC to 486/33 w/4MB RAM for Only \$497

|  |          |  |   |
|--|----------|--|---|
| VISION340DXU UPGRADEABLE   | \$700    | ALL SYSTEMS INCLUDE<br>• 4 MB RAM (70 NS)<br>• 1.2 & 1.44 Floppy Disk<br>• 101 Enhanced Keyboard<br>• Minitor Case w/220W PS<br>• 3 Button Mouse<br>**All 486 Systems are Expandable to 64 MB on Board** | Free DOS 6.2 Upgrade with System Purchase |
| VISION433DX 128k Cache   | \$950    |  |   |
| VISION450DX 128K Cache   | \$1,150  |  |   |
| VISION466DX2 128k Cache VL   | \$1,260  |  |   |
| VL BUS UPGRADE   | ADD \$20 |  |   |
| VL BUS IDE CONTROLLER  | \$40     |  |   |
| TSENG VL BUS VIDEO CARD W/1MB  | \$112    |  |   |
| WITH PURCHASE OF ANY OF THE ABOVE SYSTEMS<br>130 MB HD \$255 • 245 MB HD \$320 • .28dp SVGA \$300 • .28dp N/I SVGA \$315 |          |  |   |

No PST with Cash Purchase!

Authorized IBM & COMPAQ Service Centre  
We Specialize in HP LASERJET  
Maintenance & Repair

OVERALL COMPUTER RESOURCES  
399  
VODDEN ST. E. #69  
BRAMPTON, ONT. L6V 3V1  
PHONE: (416)451-1628  
FAX: (416)451-1032

## PROJECT X

Desktop Publishing & Amateur Radio  
Dial-Up Bulletin Board System

Huge Selection of Desktop Publishing Images, Fonts & Utilities  
Fantastic Collection of Amateur Radio/SWL Related Files  
Online Direct Access To Packet Radio  
Over 8gigs Of Online Storage  
International Message And File Feeds via. Satellite Hourly  
Exclusive Support For MNP-10 Cellular Data Communications

Toronto/Brampton

(905) 790-9311

Orangeville/Caledon

(905) 584-0729

# BBS Scanning

BY JAMES MACFARLANE

*Toronto-based Asylum BBS has extended its service across all of North America by providing a toll-free 800 number.*

For Asylum BBS owner John Howard the benefits are obvious — it gives his BBS an instant North America-wide audience. The drawback is that toll-free numbers are only toll free for the caller and not for the recipient. Figuring out how to make the BBS profitable was a little tricky for Howard.

Bell Canada's deposit for the 5-line 800 service he wanted is \$5,000, plus \$300 a month for the 800 service.

Howard hopes to offset this expense by adding it to the cost of long-distance memberships. The BBS can be called directly from the 905 and 416 area codes, but those calling on the 800-number must fork over an additional \$25 on top of the \$45 yearly membership fee and also have to pay anywhere between 60 and 90 cents per minute for connect time.

Asylum BBS can be reached at: (416)338-1428, (905)333-5133, (800)268-4359. All lines are dual-standard high speed.

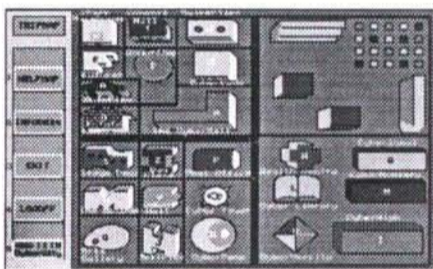

### BBSing in high-resolution.

It seems the RIP revolution is catching on. RIP stands for Remote Imaging Protocol and it allows BBSes to use quickly send VGA-quality graphics to user's screens in seconds. RIP allows BBS operators to implement graphical interfaces without buying special BBS software.

While most BBS packages now support RIP, most have simply added a graphical layer to their existing text menus. One Toronto-based BBS, CyberCity (416) 508-6222, has designed their entire BBS around the idea of it being a graphical environment. Instead of wading through menus full of technobabble you are presented with a simplified map of the city. You can go anywhere with the click of the mouse.

Compare the ease of pressing a button compared to knowing what a "conference" or selecting one item from a list of dozens. When it's all laid out and presented graphically even a first time BBSer can use the system effortlessly.

CyberCity is also one of the first BBSes to be able to offer on-line databases complete with high-resolution pictures. The images are compressed and downloaded to the user's terminal. Downloading, decompressing and viewing each picture takes about 30 seconds (640 x 480 with 256 colors).

They use a product for Major BBS called DCnet that provides the database access, which is unfortunately text-based, rather than graphical. The database is used via, our old cumbersome friend, the Command-Line Interface. It's too bad that the system drops out of their slick RIP interface back into text mode in order to view the pictures.

### Digital couch potatoes

If you were lucky enough to get a TV-tuner card for your machine this Christmas you already know you can watch TV in one window and do your homework in another

(yeah, right). Now you can do all of that and read your TV listings without having to resort to that nasty non-digital ink-on-wood-pulp stuff. U-View is a new service that provides interactive, downloadable TV listings.

U-View costs \$15 quarterly and is available for stations in the Toronto viewing area as well as cable stations like CNN.

Call (416) 932-1093 for subscription information. ■

## A FULL LINE OF ULTRA HIGH-SPEED FAXMODEMS IN UNLIMITED QUANTITY.

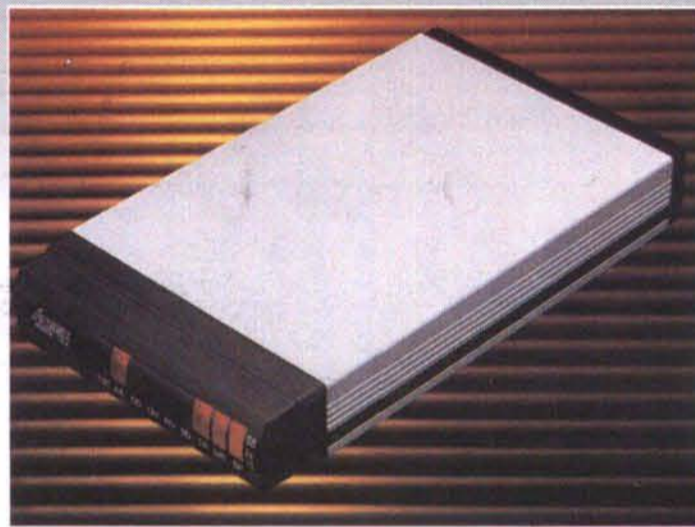

now offers the worlds' best products from V.32 to Fax modem.

### DM-1414E / DM-1414I

- CCITT V.32bis/V.32/V.22bis/ V.22/ V.21 & BELL 212A/103 COMPATIBLE.
- V.42MNP2-4 ERROR CORRECTION, 100% ERROR-FREE DATA TRANSFER.
- V.42bis/MNP5 DATA COMPRESSION, EFFECTIVE DATA THROUGHPUT UP TO 57,600 BPS.
- FULLY HAYES EXTENDED AT COMMAND SET & TR29.2 CLASS 2 COMMAND SET COMPATIBLE.
- CCITT V.29/V.27 TER & V.21 CHANNEL 2 RECOMMENDED.
- ONE-STEP CONVERSION & SENDING, BACKGROUND FAX RECEPTION.
- ASCII, BFX, IMG, PCX, TIFF BI-LEVEL, PAD-BIT & TIFF CLASS F FILES.
- BROADCAST & SCHEDULED SENDING.



5 YEAR WARRANTY

# ACCEx

ACEEX CORPORATION

All names trademarked are property of their respective manufacturers

### TORONTO

ARAX COMMUNICATIONS GROUP TEL:(416) 658-3989  
 CONNELL COMPUTER TEL:(416) 300-6308  
 FOCUS COMPUTER SYSTEMS TEL:(416) 739-6603  
 KOLMEX COMPUTER INC. TEL:(416) 669-6692  
 LOGICAL COMPUTING SYSTEMS INC. TEL:(416) 739-7260  
 MB ELECTRONICS TEL:(416) 663-3540

### SCARBOROUGH

COMPUTER RENTALS AND SALES TEL:(416) 751-7764  
 DATA FIRST COMPUTER TEL:(416) 412-0574  
 MPM INDUSTRIES CORP. TEL:(416) 254-8899  
 RAINBOW COMPUTER SYSTEM TEL:(416) 296-6133

### MARKHAM

LOGIC COMPUTER HOUSE TEL:(905) 415-0909  
 MIT COMPUTER TEL:(905) 946-0908  
 PROLOGIC SYSTEM TEL:(905) 513-8518  
 WISE GUY COMPUTERS INC. TEL:(905) 513-7002

### MISSISSAUGA

BCMOS COMPUTER TEL:(905) 279-5038  
 HYPERTECH TEL:(905) 564-8680  
 LOGIC COMPUTER TEL:(905) 276-9995

### OSHAWA

THORNBERY COMPUTER SERVICES TEL:(905) 404-8024

# Forte, Advanced Gravis Cooperate On Virtual Reality

BY GRANT BUCKLER

VANCOUVER (NB) — Advanced Gravis Computer Technology Ltd., and Forte Technologies Inc., said a new joint venture will develop products for the virtual reality market.

The letter of intent calls for formation and financing of a jointly owned company. Each partner will hold 50 percent of the as-yet-unnamed firm, said Forte spokesman Peter Matthews. The new entity is to develop virtual reality technology and products, for which it is to be the exclusive licensee, but Advanced Gravis said it will negotiate for rights to manufacture and market products licensed from the joint venture.

Formation of the joint venture depends on formal agreements on terms, conditions, and financing, and on required regulatory and government approvals.

The first product from this proposed new company is the VFX1 virtual reality headset shown at the recent Consumer Electronics Show in Las Vegas. The VFX1 combines a pair of 0.7-inch color liquid crystal displays to create a three-dimensional (3-D) image, along with proprietary 3-D head tracker to detect head motion and stereo sound.

It comes with an interface card that plugs into a personal computer and connects to the PC's existing video adapter and sound

card, Matthews explained. Software will need to be written to provide the dual video signals to drive the 3-D display, and Forte is working with software developers on this.

The device can also accept NTSC (North American Television Standards Committee) or PAL video signals from game machines such as those made by Sega and Nintendo, company officials said.

Forte, based in New York state, developed the system. The company showed a prototype at CES, and the VFX1 is expected to be ready for commercial sale by the fall, officials said.

The price is expected to be less than

\$1,000, the companies said. The VFX1 prototype shown at CES weighed close to three pounds, but the final version should weigh about 1.5 pounds, Matthews said. Ergonomic design will ensure the weight is spread evenly so the headset is comfortable to wear, he added.

Forte builds Advanced Gravis' Ultrasound audio board, and has a "good working relationship" with the Vancouver firm, Matthews said. ■

Contacts: Forte, 716-427-8595; Advanced Gravis, 604-431-5020

## Wintertree's Spell-Checker For Windows Developers

OTTAWA (NB) — Software developers that want to build a spelling checker into their programs for Microsoft Windows can get one ready-made from Wintertree Software Inc. The company has announced The Spelling Sentry, a dynamic link library (DLL) that checks spelling for Windows applications.

The first version of the software, available

now, can be used by applications written in the C and C++ programming languages. Application program interfaces for the Pascal and Visual BASIC languages are due to be available by the end of March, the company said.

The software comes with a 90,000-word main dictionary for either American English

or British and Canadian English, the company said. It also allows creation of a supplemental dictionary for the application, a user dictionary, and an exclusion dictionary.

Words in the exclusion dictionary are flagged as misspelled even if they appear in one of the other dictionaries.

Wintertree is offering the software to

application developers for a one-time fee of C\$399, covering unlimited, royalty-free distribution. A tool kit to support compressed application dictionaries is C\$199 and the C-language source code of The Spelling Sentry is available for C\$779. ■

Contact: Wintertree Software, 613-825-6271

# Truly Powerful Portables



**Sharp Newton PI-7000**  
Pen based for easy input  
Runs on standard AAA batteries  
talks to your DOS/Windows PC or MAC  
Electronic Notepad & Appointment Scheduler  
Built in metric converter, currency exchange,  
loan payment, Net present value  
fax and email options available



**Smallest 486 Notebook (NP400)**  
Weighs only 4 lbs with battery  
4MB standard expandable to 20MB  
Small size (11 x 7), 1 PCMCIA Slot  
Built in Trackball, Docking station available  
8.5" B/W LCD Backlight Display  
Full size 86 key keyboard  
Inverted T Cursor Arrangement  
80 or 120MB HDD available  
486 SLC - 33MHz Processor



**Most Powerful Notebook (NP840)**  
Intel 486 Processors (Up to 66 MHz)  
Local Bus Video for fast Windows performance  
Local Bus Hard drive - enhanced 32 bit disk  
access  
2 PCMCIA slots (Type III)  
4MB RAM Standard expandable to 20MB  
80 - 340MB HDD available, Built in trackball  
Simultaneous display on External monitor and  
panel (256 colors)  
Resolution up to 1024 x 768 on external monitor  
Docking station includes 4 slots, SCSI and more.  
Active Color, Dual Scan Passive Color and B/W  
Screens available

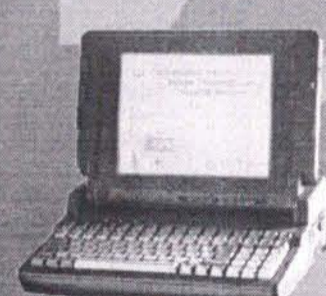

**Super MIDI Laptop**  
(PCIII Laptop)  
Standard 16 bit slot accomodates the following:  
Roland SCCI (Sound Canvas)  
Music Quest 32M MIDI Interface  
Sound Blaster compatible  
Up to 32MB RAM  
Up to 500MB HDD  
Full size keyboard with number pad



**MultiMedia Notebook**  
Business Audio System (MPC Compliant)  
Intel 486 SL 25 (3.3 Volt)  
PCMCIA Type III  
up to 340MB Removeable HDD  
4MB expandable to 32MB RAM  
Separate numeric keypad

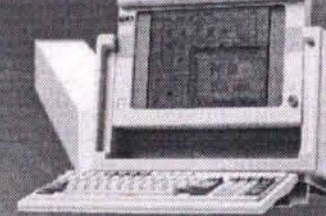

**Powerhouse Portables**  
(Lunchbox)  
486 and Pentium Models available  
Dual scan passive, Plasma, TFT or Sony Trinitron  
screens  
Up to 1.2 Gig Hard drive capacity  
3 Drive bays  
4 ISA/EISA/VLB slots  
External SVGA Port  
101 key enhanced keyboard  
Available with internal CD ROM Drives

**Portable Accessories**

Turtle Beach Multisound  
CD ROM Drives  
8 track Hard disk recording  
software

Roland RAPI0 and SCCI  
14.4 PCMCIA Fax Modems  
PCMCIA Network cards  
Parallel port SCSI adapters

**Sayson Technologies**  
**103 - 3011 Viking Way,**  
**Richmond, B.C. V6V 1W1**  
**Phone: 604-273-7305 Fax: 273-7319**

MULTIMEDIA REVIEW

# Underwater Multimedia for Youngsters

BY KEITH SCHENGILI-ROBERTS

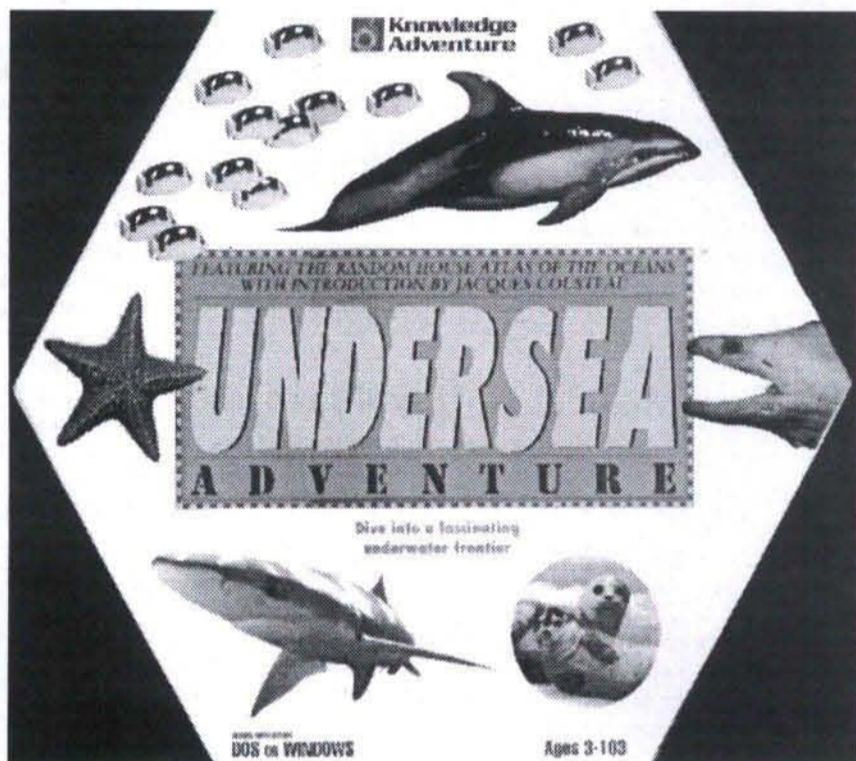

**Title:** Undersea Adventure  
**Manufacturer:** Knowledge Adventure  
**Recommended System Requirements:**  
 386SX (or better) with 520KB free RAM, 9.5MB free hard drive space, a color monitor and a mouse is recommended.  
**VGA**  
**Price:** US\$59.95 for diskette version \$79.95 for CD-ROM version

you travel through an aquarium and learn about the creatures inside it. The 3-D World also has a treasure search, where the user can search for treasure while avoiding predators.

The other learning games are all matching games, like "What Do I Eat?", where you match the predator with its favorite prey; "Who Am I?", in which you are asked the name of a particular sea creature; or "Can You Find Me?" challenging you to match the name of a sea animal to its picture. Just for fun, you could take in a show at the Undersea Movie Theatre, where you can watch a short film on a shark, porpoise or any of the other sea animals listed.

This multimedia "adventure" is filled with the spectacle of sound and pictures that young children enjoy. Lack of depth (no pun intended) is its main drawback, so older children will likely get bored with it quickly because it is not challenging enough. However, it passed a real-world test I did with a neighbor's young children.

The elementary-school-aged children who put the program through its paces enjoyed it and returned to it again and again. It can be helpful to the children in their homework as information from the program can be printed out for school projects, and younger children can enjoy exploring under the sea from the safety of their parent's home computer.

You can expect multimedia to become more prevalent in the educational system. Parents who want introduce their children to the fun of learning through multimedia will find it hard to go wrong with this program. ■

Contact: Knowledge Adventure 1-800-542-4240.

Multimedia promises to become a powerful tool in education by making computers a tool that makes learning fun. Parents looking for an affordable multimedia educational program for their children should check out Knowledge Adventure's Undersea Adventure.

This is one of very few multimedia programs that does not require a CD-ROM drive to support it — though you better have plenty of free space on your hard drive for the 9.5MB you will need if you decide to opt for the version available on diskettes. It is also available as a CD-ROM that places less stress on your system's hard drive.

The program allows the user to run the program under either DOS or Windows. However, even if you decide to run the program in DOS, you will want a Windows-capable PC to run it on because of the large memory resources it needs for the animation sequences.

There are plenty of animated sequences, and if you have almost any type of sound card, it has a delightful array of appropriate aquatic bubbling, blurping and blooping sounds. All of the picture sequences are accompanied by spoken and written text, allowing even the pre-schooler to follow along.

There's plenty to do in this program. You can explore the 3-D Undersea World, where

## CD ROM DRIVES

Featuring The World's First **TRIPLE SPEED CD-ROM Drives** **PC & Mac**  
**NEC Multispin 3X Series**  
 450KBs Data Transfer/195ms Access Time/256K Cache  
**NEW**

| Model | Interface                  | Access Time | Cache | Price   |
|-------|----------------------------|-------------|-------|---------|
| 3Xi   | Internal Multispin         | 195ms       | 256K  | \$ Call |
| 3Xe   | External Multispin         | 195ms       | 256K  | \$ Call |
| 3Xp   | Portable Multispin (250ms) | 250ms       | 256K  | \$ Call |

\* **PC Multimedia Kits Include:**  
 One of the above CD-ROM Drives  
 Pro Audio Spectrum 16-bit Sound Card with Multimedia Speakers  
 Kodak Photo-CD Access Software  
 + 5-Title Micro Drives PCL Library  
**Optional SCSI Interface (PC Only) \$ 79**

## CD ROM DRIVES

**Sun Moon Star™** **PC**  
**Toshiba 3401 DS Drive**  
 (330KBs/200ms Access/256K Cache)  
**SOAR** **NEW**  
 Let Your Imagination Soar  
**Internal**  
 Drive Kit Only \$ 289  
 Drive Kit + CD-PAK for DOS \$ 389  
 Drive Kit + CD-PAK for Windows \$ 499

**Sony 33A DS Drive**  
 (300KBs/390ms Access/64K Cache)  
**Internal**  
 Drive Kit Only \$ 289  
 Drive Kit + CD-PAK for DOS \$ 389  
 Drive Kit + CD-PAK for Windows \$ 499

**Panasonic 562 DS Drive**  
 (300KBs/320ms Access/64K Cache)  
**Internal**  
 Drive Kit Only \$ 299  
 Drive Kit + CD-PAK for DOS \$ 399  
 Drive Kit + CD-PAK for Windows \$ 499

**Sony 561 DS Drive**  
 (330KBs/280ms Access/256K Cache)  
**Internal**  
 Drive Kit Only \$ 499  
 Drive Kit + CD-PAK for DOS \$ 599  
 Drive Kit + CD-PAK for Windows \$ 699

## CD CHANGERS

High Performance Multi-Disc CD-ROM Players  
**Pioneer 602X 6-Disc Double-Speed Changer**  
 (307KBs/300ms Access/256K Cache)  
 External 6-Disc Changer + SCSI Interface Card \$1599  
**Pioneer 604X 6-Disc Quad-Speed Changer**  
 (614KBs/300ms Access/256K Cache)  
 External 6-Disc Changer + SCSI Interface Card \$1999  
**Pioneer 1804X 18-Disc Quad-Speed Changer**  
 (614KBs/300ms Access/256K Cache/Changes under 5 Sec.)  
 External 18-Disc Changer + SCSI Interface Card \$3299

## RECORDABLE CD

**Phillips CD-521 CD-ROM Recorder**  
 Double Speed Record/Playback  
 CD Recorder + Corel CD Recording Software  
 CD-R Recordable Disc Media (640MB Capacity) \$6999  
**35**

## GO OPTICAL!

**128MB 3.5"** **650MB 5.25"**  
**Panasonic 40ms Rewritable** **Pioneer M/D Rewritable/WORM**  
 Kit includes: SCSI Interface Card, Mounting Hardware, Manuals + 2 - 128MB Optical Cartridges \$1299  
 Kit includes: SCSI Interface Card, + 1 Rewritable Cartridge & Manuals \$2799



18 Regan Road, Unit 31  
 BRAMPTON, Ontario L7A 1C2  
 Mon.-Fri. 9am-6pm Sat. 11am-5pm

For Your Convenience We Accept:



... plus Corporate and Government POs

## We Offer:

All-Canadian Worry-Free Warranty

30-Day Money-Back Guarantee

Fast Delivery Anywhere in Canada

Toronto Area Phone:

**(905)840-6476**

Fax: **(905)840-6560**

Canada-Wide Toll-Free Ordering **(800)268-4389**

All prices cash discounted; subject to change without notice.

## HARD DRIVES

**Quantum** **PC**  

| Capacity | Access Time | Price  |
|----------|-------------|--------|
| 127MB    | 17ms        | \$ 259 |
| 170MB    | 17ms        | 269    |
| 270MB    | 12ms        | 379    |
| 540MB    | 10ms        | 799    |
| 700MB*   | 10ms        | N/A    |
| 1G1G*    | 10ms        | N/A    |
| 1.2G1G*  | 12ms        | N/A    |
| 1.8G1G*  | 10ms        | N/A    |

 IDE SCSI  
 5 Year Warranty  
 Years All Others

**Maxtor** **IDE SCSI**  

| Capacity | Access Time | Price  |
|----------|-------------|--------|
| 245MB    | 15ms        | \$ 339 |
| 345MB    | 14ms        | 399    |
| 540MB    | 8.5ms       | N/A    |
| 1.2G1G   | 8.5ms       | N/A    |

 2 Year Warranty

**Seagate** **IDE SCSI**  

| Capacity     | Access Time | Price  |
|--------------|-------------|--------|
| 1G1G         | 10ms        | \$1449 |
| 1.7G1G       | 9ms         | 1899   |
| 2G1G/5.25"   | 13ms        | 2199   |
| 2.1G1G/3.5"  | 9ms         | 2599   |
| 2.9G1G/5.25" | 11ms        | 3399   |

**BARRACUDA Drives (F A S T - 1MB Cache!)**  
 1.6G1G/3.5" 8ms \$2499  
 2.1G1G/3.5" 8ms 2899

**WESTERN DIGITAL** **IDE SCSI**  

| Capacity | Access Time | Price  |
|----------|-------------|--------|
| 213MB    | 13ms        | \$ 299 |
| 256MB    | 13ms        | 329    |
| 342MB    | 12ms        | 399    |
| 426MB    | 12ms        | 499    |
| 540MB    | 11ms        | 799    |

 3 Year Warranty

**FUJITSU** **IDE SCSI**  

| Capacity | Access Time   | Price  |
|----------|---------------|--------|
| 330MB    | 12ms          | \$ 699 |
| 520MB    | 12ms          | 799    |
| 1.06G1G  | 12ms(5400rpm) | 1299   |
| 2G1G     | 11ms(5400rpm) | 2799   |

 5 Year Warranty

**SyQuest REMOVABLE** **PC & Mac**  

| Capacity             | Access Time | Price  |
|----------------------|-------------|--------|
| 5.25" 44MB/20ms      |             | \$ 439 |
| 5.25" 88MB/20ms      |             | 599    |
| 5.25" 88MB/44MB/20ms |             | 699    |

 Mac Cartridges \$ 589 \$ 799 \$ 869  
 \* Internal Drive with 1 Cartridge

**MIGHTY driver** **High Performance, Value-Priced Hard Drives for the Mac.**  
 240MB to 2G1G! \$Call

## TAPE BACKUP

Because Accidents Happen! **PC**  

| Capacity                          | Access Time | Price  |
|-----------------------------------|-------------|--------|
| Colorado Memory Systems 120MB     |             | \$ 159 |
| Colorado Memory Systems 250MB     |             | 269    |
| OS/2 Software                     |             | 149    |
| Jumbo Trakker Parallel Port 120MB |             | 449    |
| Jumbo Trakker Parallel Port 250MB |             | 539    |
| Conner 250MB - Int.               |             | 239    |

**CONNER SCSI Drives** **Int. Ext. Price**  
 2G1G DAT Kit \$1699 \$1899  
 520MB \$699 \$849  
 999

**EXABYTE 8mm - Up to 5GIGs! \$Call**

## BERNOULLI REMOVABLE

Performance of a Hard Drive; Never a Head Crash!  
**MEGA** 150MB/18ms PC Powered \$ 699  
 150MB/18ms Transportable 799  
 35MB, 65MB, 90MB, 105MB 150MB Cartridges \$ Call

## MEMORY

High Performance, Value-Priced Hard Drives for the Mac.

## INSTALLATION

SAME-DAY SERVICE!

Canada's Storage Experts

1994 5 YEAR Anniversary

18 Regan Road, Unit 31 Brampton, Ontario L7A 1C2

Mon.-Fri. 9am-6pm Sat. 11am-5pm

For Your Convenience We Accept:

VISA MasterCard

... plus Corporate and Government POs

Toronto Area Phone: (905)840-6476

Fax: (905)840-6560

Canada-Wide Toll-Free Ordering (800)268-4389

All prices cash discounted; subject to change without notice.

BRAMPTON

# Twinhead

**POWER PLUS!**



## SUBNOTE CYRIX 486 SLC-E

A COMPACT SIZE PORTABLE COMPUTER PACKED WITH POWER AND PUNCH. FAST 33 MHz, LIGHTWEIGHT 4 LBS., DURABLE 4 HOUR BATTERY LIFE, BUILT-IN TRACKBALL, PCMCIA SLOT, AND LOTS MORE FEATURES.



**SUPRA 14" AND 15"**  
COLOUR MONITORS  
SUPER VGA  
LOW RADIATION  
NON-INTERLACED  
FLICKER FREE

**OKIDATA**  
OL400e



LED Page Printer  
The Perfect Fit

- ◆ Compact size for a perfect fit for any office
- ◆ 44 built-in fonts for a perfect look to any job
- ◆ Speedy, 4-ppm printing with RISC microprocessor - perfect for productivity
- ◆ Perfectly compatible with virtually all software applications
- ◆ 5-year Printhead Warranty

Distributed by:

**PATCO COMPUTERS LTD.**

DISTRIBUTORS OF COMPUTER PRODUCTS

#106 - 3830 Jacombs Road, Richmond, B.C.

Tel: (604) 273-4408 Fax: (604) 273-2903

#3, 3610 - 29th Street N.E., Calgary, AB

Tel: (403) 250-5340 Fax: (403) 250-7523

10340 - 176th Street, Edmonton, AB

Tel: (403) 489-1177 Fax: (403) 489-9777

Dealers Enquiries Welcome

## THINKPAD

# Pen PCs Help To Out At 94 Commonwealth Games

BY STEVE LYNETT

Medical Staff working with athletes at this summer's Commonwealth Games will be making a significant break with tradition. They're turning in keyboards and many of their paper forms for a radically new method of electronic information gathering.

Doctors and nurses at the Victoria, B.C. games will be recording health data and medical findings on state-of-the-art, pen-based computers.

Roughly the size of a clipboard, the new computers allow the operator to use a special pen to write or draw on an etched-glass surface. The unit does not have a conventional keyboard. However, a keyboard image can be called up to the screen and manipulated with the computer's pen.

Doctors planning for athlete care during the hectic 10-day games say pen-based computing represents a significant breakthrough in medical record taking. And if initial tests are any indication, they expect the system will be faster and less error prone than traditional methods.

Dr. Richard Backus, Chairman, Athlete Medical Services, Victoria Commonwealth Games Society, says: "A big problem with traditional computerized records is the need for an intermediary. Most doctors these days just aren't proficient enough with computers. Or, if they are, they're slowed down because they tend to use too many words."

The pen-based computers will change the way information is gathered. Most data will be entered simply by tapping on-screen prompts, but the computer will also recognize and convert handwriting, all electronically.

Ease of use is vital with little opportunity to train the largely volunteer staff who will be using the new equipment — IBM's ThinkPad 710T. Powered by an IBM 486SLC/25 Mhz microprocessor, the notebooks are being supplied by games-sponsor IBM Canada Ltd.

Initial users have found that writing with the computer's special pen on the screen's surface feels similar to writing on paper, the result of a unique etching process used on the glass. The system's fast digitizer makes pen strokes appear almost immediately. The back-lit display can be read in any light, indoors or out.

About a dozen ThinkPads will be in use at the Village Medical Centre and selected sports venues.

Software for the games was developed by Irina Sladeczek of the University of Victoria's School of Health Information Science, working as a co-op student for the Commonwealth Games Society. Using a software

development system called Numero, from PenMagic Software Inc., Sladeczek developed the application in less than two months.

During initial encounters, medical staff will record most patient information simply by tapping the pen beside on-screen prompts — including area of the body, type of injury and treatment. Little actual handwriting is required.

At day's end, information gathered in the ThinkPads will be transferred to either a standalone PC or a network for analysis. Detailed reports will be generated for use during the current games. And, if medical staff have their way, a full report will be available to help plan the medical requirements of future games.

During its first field test at a badminton tournament in September, 1993, the sys-

tem earned high praise. Some 50 physicians, physiotherapists and other support staff, took part in the test.

If the Victoria games test proves as effective as the medical staff hopes, it could set a standard for future events.

Says Dr. Backus: "When we started planning for Victoria, we had statistics from other games, but they were not gathered in a consistent fashion. The information was interesting, but not very comprehensive."

To illustrate his point, Backus cites just one example. "We have no idea how many band aids were used at the last games," he says.

Dr. Backus also talks about trends. "If we get a blip of sunburn complaints, we can get an advisory out on the use of sunscreen.

"That's immediate value."

Dr. Jochen Moehr, Professor of Medical Informatics at the School of Health Information Science, is also enthusiastic about the new technology.

"I'm convinced it will be accepted and used," he says. "The computer suits the application and the software is a superb application development tool."

"The ability to record images, sketches or simple doodles is great for a doctor," explains Moehr. "Sketches in a medical record can convey a great deal of information."

While ThinkPad's use in Victoria will be limited to data collection, the doctors involved see much greater potential.

According to Dr. Moehr, the bulk of the medical profession has long felt a need for portable computers. "Medical professionals are constantly on the move. It would be extremely useful to have a portable, unobtrusive device in meetings and at the bedside. ■

Steve Lynett works for a Toronto-based public relations firm that represents IBM.

**Medical staff will record most patient information simply by tapping the pen beside on-screen prompts.**

A competitive edge. That's what it's all about. And one of the easiest ways for your

need to continue to grow and to be successful. How do we do this? We'll offer

the entire amount on a single new employee, or you can split it to cover the further

**Y o u r C O M P E T I T O R  
J U S T R E C E I V E D \$ 1 0 , 0 0 0  
t o T R A I N n e w S T A F F .**

business to gain the upper hand on your competition can come from hiring and training new staff. Now, you're probably thinking the last thing your business can afford is new employees. You're probably right. That's why we're here to help. We're jobs Ontario Training. Our goal is to help your business find the staff you

you up to \$10,000 - or 35% of salary - to be put towards the training of each new

**Read this ad quickly**

employee, every time you create a new position. We screen registered applicants to match their abilities to your needs. The person you select is entirely up to you. It's that simple. The training credit is flexible. You can use

training of your existing staff. So far we've helped place over 20,000 people in all kinds of business, both large and small. In companies like your own. And in companies like your competitors. If you'd like to know more, give us a call. Dial quickly, and hope your other competitors are still reading the headline.



**jobsOntario • Training**

 Ontario

# what's new

## Canon Funds Wildlife Conservation

Canon Canada has donated \$50,111 to two wildlife conservation organizations as part of its Clean Earth Campaign. The World Wildlife Fund Canada and Nature Conservancy of Canada each received approximately \$25,000.

Since 1991 Canon Canada has donated \$99,496 to the two organizations under the program. The amount Canon donates from year to year depends on the level of consumer participation in the campaign.

For every empty toner cartridge collected through the Clean Earth Campaign, Canon donates \$1. Canon encourages consumers to return their empty toner cartridges by offering several convenient options to return cartridges and by covering shipping costs.

Canon completely remanufactures empty toner cartridges used in office equipment such as personal photocopiers and facsimile machines. Plastic is turned into pellets, melted and poured to form a new cartridge. Aluminum parts undergo a similar process and packaging is recycled.

Contact: Canon Canada, 905-795-2111

## Multimedia RISC

Hewlett-Packard has introduced what it claims is the first RISC processor with built-in multimedia capabilities. The PA-7100LC, which HP calls an entry-level RISC chip, includes a new set of instructions that operate directly on video pixels or audio samples, according to the company. The chip is able to render high-quality full motion video and imaging without external hardware, and can support established standards such as MPEG and JPEG.

The PA 7100LC contains a second integer unit which makes it a full, two-way superscalar processor that can execute two instructions simultaneously. The chip also incorporates a memory controller and input-output controller.

The chip measures 14 mm x 14 mm and contains 800,000 transistors.

Contact: Hewlett-Packard Canada Ltd. 1-800-378-3867

## 3D Does Commodore

3D Microcomputers and Commodore Business Machines Limited have entered into an

agreement whereby 3D Micro is assuming manufacturing and distribution responsibilities for Commodore DOS-compatible personal computers in Canada.

3D Micro's manufacturing division has been building Commodore Canada's DOS-compatible equipment under an OEM (original equipment manufacturer) agreement for specified markets since 1991. Under the terms of the new agreement, 3D Micro will manufacture and distribute Commodore DOS-compatible equipment. In addition, they will be responsible for all marketing activities for non-government, educational, or institutional sales of Commodore DOS-compatible equipment.

Contact: 3D Microcomputers, 905-479-8822 (TO), 604-873-5595 (BC), 403-250-2590 (Calg), 403-484-0151 (Edmnt), 514-333-3922 (Mtr), 506-853-8338 (Atlant), Commodore, 416-499-4292

## Dell's Pentiums

Dell Computer Corp. (Canada) has introduced its second line of Pentium-based computers.

The Omniplex series incorporates Peripheral Component Interconnect (PCI) local bus and Extended Industry Standard Architecture (EISA) peripheral bus designs.

The Model 560 uses a 60 MHz Pentium processor while the Model 566 uses a 66 MHz version of the chip. Both models come with 120 MB IDE hard drives, but SCSI II drives with capacities of up to one gigabyte are also available.

Standard are 8MB of RAM, a 120MB hard drive, 256K of cache memory, mouse, keyboard, SuperVGA color monitor, DOS 6 and Windows 3.1. Both models come in mid-size desktop cases and sell for \$4,709 (Model 560) and \$5,389 (Model 566).

Contact: Dell Computer Corp. (Canada) 416-764-4200

## Lottery Software for Windows

CPProgram Software Inc. has released Hot-to-Lotto Lottery Gaming, a program that runs under Microsoft Windows.

According to the company, Hot-to-Lotto helps Lotto players increase their odds and enhances their enjoyment of the game. The program ships with databases for all Canadian Lotto 6/49 versions, BC/49, and Quebec Select 42, and several U.S. databases. Additional databases are provided on request and are available for download from the CPProgram Software support BBS.

Users can display information from the databases to find current trends in the statistics for the various lotteries. Winning statistics from previous draws can be graphed in many different ways and the user can formulate picks based on assessments the program provides. Hot-to-Lotto formulates wheels for any set of numbers, either obtained from the database or entered by the user. Also, the

user can create a database of their own picks and track their progress against the actual statistics.

System requirements are a 386 or higher end machine running Microsoft Windows 3.1. At least 2MB of memory are suggested. Hot-to-Lotto is supplied on two 3.5 inch HD floppy disks. Suggested retail price is \$49.95. Dealer inquiries are welcome.

Contact: CPProgram Software, 604-438-2693

## Legacy Arrays Support Windows NT

Legacy Storage Systems in Markham, Ont. is supporting Windows NT desktop and Advanced Server. The Legacy SmartArray is an intelligent disk array with on-board advanced diagnostics that can be configured as a RAID level-5 disk array running under Windows NT Advanced Server. The subsystem can hold up to nine half-height devices for a total capacity of 18 gigabytes (GB). An optional 4 GB DAT (Digital Audio Tape) drive with full Windows NT file system support can be included for additional security.

Pricing for the Legacy SmartArray starts at \$10,000 for a 2 GB configuration.

Contact Legacy, Toronto 905-475-1077; Montreal 514-365-9613; Ottawa/Hull 819-457-4858; and Vancouver 604-924-1065.

## Logitech Sets Up Canadian Office

Logitech, best known as a maker of computer mice and for its "senseware" line of computer peripherals, has just opened up a Canadian office in Mississauga, Ont. It will be the national centre of its marketing and sales efforts.

Logitech Chairman and co-founder Daniel Borel officially opened the office, affirming the strategic role of the Canadian market (its third-largest world-wide), and Logitech's focus of providing "senses" to the computer. Its scanners, mice, digital cameras and other related devices are all part of the company's plan to make computers easier and more comfortable for people to use while providing computers with greater flexibility.

The Canadian office will now be the focus for nation-wide promotions involving Logitech.

Contact: Logitech Canada 1-800-667-5644 or 905-629-2006

## Keycard Security for Your PC

When the media looks at the issue of computer security, it tends to look at the sensational cases of computer hackers breaking-in over phone lines to distant machines. The fact is that most illicit hacking is done on the premises, often by fellow employees or people with direct access to the computer. It

February **Specials** 1994 

**Two Year Parts & 3 Year Labor Warranty**

|  |  |
|--|--|
| <p><b>VL-BUS 486DX/33 256K</b></p> <ul style="list-style-type: none"> <li>*** Upgradable to P24T OverDrive</li> <li>*** AMI Bios, Intel CPU in side,</li> <li>*** 245MB Hard Drive 15ms 64K</li> <li>*** 4MB RAM 70ns exp up to 32MB,</li> <li>*** 1M VL-BUS 1024x768 SVGA Card</li> <li>*** 14" N/Int. SVGA Monitor .28dpi,</li> <li>*** IDE controller 2S/1P/1G port,</li> <li>*** Mini Tower Case 200W PS,</li> <li>*** 101 Enhanced Keyboard,</li> <li>*** MS Comp. Mouse, Mouse Pad</li> </ul> <p style="text-align: center;"><b>\$1599</b> <small>\$77/mth</small></p> | <p><b>VL-BUS 486DX2/66 256K</b></p> <ul style="list-style-type: none"> <li>*** Upgradable to P24T OverDrive CPU,</li> <li>*** AMI Bios, Intel CPU in side, CPU Cooler Fan,</li> <li>*** 340MB Hard Drive 13ms 128K buffer,</li> <li>*** 8MB RAM 70ns exp up to 32MB,</li> <li>*** 2M VL-BUS 1280 x 1024 SVGA Card 72Hz,</li> <li>*** 15" N/I L/R 1280x1024 SVGA Monitor .28dpi,</li> <li>*** VL-BUS 32-bit IDE controller 2S/1P/1G port,</li> <li>*** Mid. Tower Case 5 Ext. &amp; 3 Int. Bays, 230W,</li> <li>*** 101 KeyTronic Enhanced Keyboard,</li> <li>*** MS Comp. 3-button Mouse, Mouse Pad</li> </ul> <p style="text-align: center;"><b>\$2399</b> <small>\$114/mth</small></p> |
|--|--|

**B.U.S. Computers** Bonus with each system... Details in Store  
**Tel: (416) 253-0689 Fax: (416) 253-6809**  
 80 Park Lawn Rd., Suite 302, Etobicoke, ON M8Y 3H8  
Prices & Specifications Subject to Change without Notice. Corporate and Government P.O. welcome.

**ECEpc 433VLNI SYSTEM**

- Intel 486DX33 MHz • 3VESA • 128K Cache
- 4 MB RAM • 1.2 MB, 1.44 MB F.D. • 260 MB H.D.
- VESA SVGA w/1 MB • VESA IDE card w/2S, 1P, 1G
- Mitsumi 101 Keyboard • Mini tower case • Mouse
- SVGA NI .28dp monitor

**\$1595**

**2 Year Warranty**  
ECE PC 

308 College St. Toronto, Ont. Tel: (416) 324-9247 Fax: (416) 324-9654

|   |   |
|---|---|
| <p><b>SPECIAL \$339</b><br/><b>CANON BJ200</b></p> <ul style="list-style-type: none"> <li>• Sound Blaster 16 \$195</li> <li>• Sound Galaxy Pro \$195</li> <li>• Jumbo 250 \$250</li> <li>• Canon BJ10SX \$285</li> <li>• Canon BJ600 \$795</li> </ul> | <p><b>BROTHER PRINTER PROMOTION SALE</b></p> <ul style="list-style-type: none"> <li>• Brother InkJet \$339</li> <li>• Brother LaserPrinter \$699</li> <li>• 1.44 Disk \$5.95</li> <li>• 170MB \$240</li> <li>• 270MB \$305</li> </ul> |
|---|---|

**ECHON** WITH YOU ANYWHERE 

# ESP



## KEY TO SUCCESS

ESP's advanced keyboard technology brings you comfort, reliability and durability never before experienced. You will never again throw out a keyboard because of one bad key. Customized engineering means each key is independently structured so you can quickly and easily replace the faulty key. With a proven record of 30 million lifecycles per switch it will, however, be a long time before any repair is needed. You can even spill coffee on our keyboard because it is spill resistant.

The keyboard typematic speed is easily adjustable to 8 levels to suit your personal taste. Other built in features include hot keys for keyboard lock and a handy speaker on/off control. For a very affordable price you will get that IBM quality, tactile feel.

Available in 24 language templates, our keyboards are FCC class B and TÜV approved and backed by a two year manufacturer's warranty. They are both AT and PS/2 compatible.

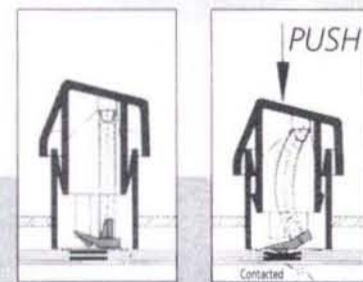

Customized engineering that uses only the best keyboards components with German Patent No. G 9211065.7, R.O.C. Patent No. 188657 U.S.A. Patent No. 07-691826, China Patent No. 92232015.2

#### DISTRIBUTED BY:

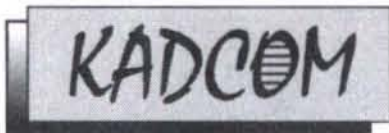

*We Build a Computer, You Build a Future.*

#### KADCOM COMPUTER PRODUCTS INC.

50 West Wilmot Street, Unit 5,  
Richmond Hill, Ont. L4B 1M5  
Tel: (416) 886-6668 Fax: (416) 886-6691

#### LOCAL DEALERS:

##### TORONTO

HITS  
TEL: (416) 586-0020

CHOICE 2000  
TEL: (416) 368-5909

RICHMOND HILL  
HITS  
TEL: (905) 889-6513

##### MARKHAM

MIT COMPUTER SUPPLIES  
CO. LTD.  
TEL: (905) 946-0908

ZEGNA ELECTRONIC  
TEL: (905) 479-8892

STEALS DIRECT  
TEL: (905) 475-3999

FAMOUS FUMDA  
TEL: (905) 946-1188

WISE GUY COMPUTER  
TEL: (905) 513-7002

##### SCARBOROUGH

HITS  
TEL: (416) 754-8887

WISE GUY COMPUTER  
TEL: (416) 750-9009

PORT COLBORNE  
HITS  
TEL: (905) 835-2244

##### MISSISSAUGA

HITS  
TEL: (905) 238-8701

ZEGNA ELECTRONIC  
TEL: (905) 848-9822

STEALS DIRECT  
TEL: (905) 602-8333

WISE GUY COMPUTER  
TEL: (905) 803-8090

##### WOODBRIIDGE

CHOICE 2000  
TEL: (905) 856-2840

ESP is trademark of Kadcom Computer Inc.  
IBM AT, PS/2 are trademarks of International Business Machines Corporation.  
Specifications are subject to change without notice.

# what's new

is much easier for somebody to copy data out of an unsecure machine — and often the original user has no idea anything has happened.

Roswin Computer Corp.'s Security Key-card System uses a simple keycard security system that restricts access to the computer. People who are allowed access to the computer are given a pass card of roughly the same dimensions as a credit card, with an encoded magnetic strip. When installed, the computer prompts the user for the card. If you are admitted to the system, a green pass light appears and you can continue using the computer. If not, the keyboard and the system are locked up, so data cannot flow in

or out of the computer.

The card reader is compact, and is designed to fit easily into a 3.5" drive bay (a 5.25" frame is also available). The reader connects to the key-lock system that is available, but not always enabled, on most PCs. Each kit comes with instructions on how to do the wiring yourself, though novice computer users should probably get a professional to do the installation.

Contact: Roswin Computer Corp. (905) 470-8999

## Microrim Introduces Accounting Package

Microrim, best known for its R:BASE relational-database software, has introduced In The Black, which the company claims is the first Windows accounting software package aimed at small business and home use.

It is a complete general ledger accounting package, and uses a double-entry system with an audit trail to keep accurate accounting records. It features full accounts payable and receivable, budgeting and invoicing. It can also present financial analyses in any of several different standard accountancy report styles.

It includes a database system to keep track of business and personal contacts. In

The Black will also let users configure the system to display headings in either correct accounting terminology or plain English, depending on what the user is comfortable with. It will run on any Windows-compatible computer, and is available for a suggested retail price of \$89.95 U.S.

Contact: Microrim (206) 649-2551

## Optika Imaging System Available in Ontario

K-L Software Associates Inc., has recently reached an agreement with Optika Imaging Systems Inc. of Colorado to act as an authorized distributor of their FilePower program. FilePower is imaging software designed to reduce the need for keeping paper-based records. It runs under Windows, is client/server based, and can be integrated into PC networks and mainframe computers.

K-L Software Associates provides professional consulting services, training, imaging software and supplies.

Contact: K-L Software Associates (416) 570-0707

## Multimedia Projector

Graphical Corp. in Toronto has introduced what it calls the first portable multimedia projector. The LitePro 550 LS is a self-con-

tained data projector that integrates an overhead projector, active matrix LCD panel, stereo speakers, microphone jack, video connection and a computer controlled presentation delivery system.

The unit will accept video signals from a VCR, laser disc, or camcorder. Up to four computer or video sources with stereo sound can be combined.

List price is \$13,995.

Contact: Graphical Corp., 416-921-4447; fax 416-921-7480.

## Cars by Fax

Using the latest in automatic faxback technology, Auto Fax Info allows users to select information on cars from a list of documents. It is the first auto publication to provide information-on-demand to people equipped with fax machines or fax/modems.

The service is a combination of an automotive magazine and business directory. It has new and used auto specifications, a dealer directory, feature articles, automotive news, private classified ads and much more.

The service is very easy to use. Users dial (905) 457-AUTO from a touch-tone telephone or fax machine, and an automated voice system provides the user with a number of documents which the user can choose to have faxed to a number they specify at the end of the call.

The costs of the operation are handled by advertising revenue, so the service is free to all users save for the cost of fax paper.

Contact: Auto Fax Info (905) 456-2260

| UPGRADE   |                       |                       |                       |
|---|-----------------------|-----------------------|-----------------------|
| FREE INSTALLATION (486 MAIN BOARD WITH LOCAL BUS 32 BIT)                  |                       |                       |                       |
| 128 cache<br>386DX-40   | 128 cache<br>486SX-25 | 128 cache<br>486DX-33 | 128 cache<br>486DX266 |
| \$159   | \$269                 | \$489                 | \$769                 |
| Local Bus Super IDE Controller 2S/1P/1G                                   | \$42                  |                       |                       |
| Local Bus VGA Card with 1MB exp to 2MB                                    | \$139                 |                       |                       |
| Case Desktop/Minitower / Fulltower  | \$69 / \$165          |                       |                       |
| Floppy Drive (5.25") 1.2MB / (3.5") 1.44MB                                | \$57 / \$53           |                       |                       |
| Memory SIMM 1MB (70)  | \$55                  |                       |                       |
| Hard Drive 240MB / 340MB  | \$299 / \$399         |                       |                       |
| Colorado Tape Drive (int) 250MB / Trakker (ext) 250MB                     | \$189 / \$469         |                       |                       |
| GVC 14,400 Fax/Modem / ATI 14,400 Fax/Modem                               | \$234 / \$209         |                       |                       |
| Panasonic int. double speed CD-ROM with Speakers                          | \$315                 |                       |                       |
| Mitsumi double speed CD-ROM   | \$289                 |                       |                       |
| Low Low Prices on Printer Ribbons and Diskettes                           |                       |                       |                       |
| HP Toner Recharge only \$45   |                       |                       |                       |
| 486DX 33 Local Bus 32 bit with 256K cache complete system for only \$1699 |                       |                       |                       |
| Financing available. Please call for further details.                     |                       |                       |                       |
| <b>COM BUSINESS SERVICE CENTRE</b>  |                       |                       |                       |
| 1785 Queen Street East (Parkside Plaza) Bramalea                          |                       |                       |                       |
| Tel: (905) 799-2600 Fax (905) 799-2601                                    |                       |                       |                       |
| All prices are cash discounted. Prices subject to change without notice.  |                       |                       |                       |

# POCO™

The Postal Code Lookup Program

## Finds Canadian postal codes FAST!

- Includes DOS and Windows versions.
- Uses just 4 Meg. of disk space.
- Hotkey or mouse activated.
- Can be used from within most applications — full address can be autocopied back.
- Now with **Reverse Lookup** — searches backwards from code to address.
- Locates RPOs from box numbers.
- Displays Large Volume Receiver names.
- Single-user version just \$59\* — network and site licences available.
- Fully bilingual — English/Français.
- 30-day money back guarantee.

**(416) 531-4227 (Toronto area)**

**(800) 567-9074 (toll-free)**

**Dealers welcome!**

Sector Publications Inc., Box 738 Station "C", Toronto, ON, M6J 3S1

\* plus applicable taxes, and \$6 shipping and handling.



*This is what the future looks like.*

**HUGE COLOUR SCREEN! OPTIONAL CD-ROM! EXPANDABLE!**

### FEATURES

- ◆ Huge 10.4" Colour Active Matrix Screen
  - ◆ Intel® 486SX 25 Mhz Power
  - ◆ Lightweight battery pack
  - ◆ Removable floppy drive
  - ◆ 200 Mb 2.5" hard drive
    - ◆ PCMCIA slots
    - ◆ Mini trackball

### OPTIONS

- ◆ Video Tuner
- ◆ CD-ROM drive
- ◆ Docking station
- ◆ 9.4" monochrome backlit screen
- ◆ 9.4" monochrome pen display with digitizer for pen computing
- ◆ Expandable to 20 Mb RAM

**Raven**

For more information or the dealer nearest you, please call or fax Serviceworks at:  
 Vancouver: (604) 273-4453/Fax: (604) 270-7150  
 Toronto: (905) 712-2000/Fax: (905) 712-0041  
 Montréal: (514) 344-4044/Fax: (514) 344-4008

**Serviceworks**  
Distributors Inc.

# newsbytes

EXCLUSIVE NEWS

## Interactive Titles Tested In Bookstores

NEW YORK — The next time you go to the bookstore, you might encounter "volumes" and "titles" of a different variety than you would ordinarily expect.

Six major electronic publishers — The Voyager Company, Apple Computer, Time Warner Interactive Group, Macmillan New Media, Creative Multimedia Corp., and Discis Knowledge Research — have launched a market test of interactive entertainment software in bookstores.

A Coles Bookstore in Toronto is the sole test site in Canada.

Contact: Voyager Company, 212-431-5199

## Vigilant Watches Over Your Money

BY KEITH SCHENGLI-ROBERTS

Vigilant Software has just released a new version of its accounting package aimed at retailers. Vigilant Business Software 6.4 now includes bar-code reading, bar-code printing and direct swipe credit card authorization as part of the program, designed as an integrated accounting/point-of-sale system.

Vigilant provides an interface that is easy-to-use and uncluttered, making basic accounting and inventory procedures effortless. It can be modified to suit to the needs of any type of business, and the number of different processing fields is limited only by available hard disk space. Users can easily keep track of current accounts, vendors, customers and inventory using Vigilant.

You only have to enter data once; it is passed on by the program to all relevant data fields, including the general ledger, which is updated automatically. So when a sale is made at the cash register, it is automatically passed along to the other integrated inventory and accounting components of the program. Vigilant also keeps track of sales history, providing a complete breakdown of what was bought and when, along with inventory figures.

Other new features include the ability to track inventory by serial and lot number, deal with returned goods and exchange transactions, and the ability to process rental items at the point-of-sale screen.

Vigilant Business Software version 6.4 is available for \$495 for a single user version, and \$695 for the networked version.

Contact: Vigilant Software (416) 322-5744

## Post-It Electronically

FORT COLLINS, CO — Have you ever just given up on leaving a note for someone because you didn't want to scramble around hunting for a paper and pencil? Voice It Technologies of Fort Collins, CO says you

will never have that hassle again with its credit-card sized record and playback unit that uses a computer chip to take fast, easy messages.

The company claims its new Voice It Personal Note Recorder can be used to quickly record the great idea that popped up during

the drive to work, tell the kids to look in the refrigerator for their after-school snack, remember those grocery list items, and record sales leads without wasting time and energy.

Contact: Voice It Technology, tel 303-221-1705, fax 303-221-2058

## THE 3RD ANNUAL HOME OFFICE SHOW AND TELECOMMUTING EXPO



Photo courtesy of "Year" Northern Telecom

MARCH 23 - 24, 1994 ~ METRO TORONTO CONVENTION CENTRE

**Home-Based Entrepreneurs, Telecommuters and Corporate Decision Makers...SEE IT ALL!**

*Attendees*

**Go one-stop shopping...**examine over 150 exhibits and hundreds of products providing the very latest developments in home office and telecommuting technologies, products and services

**Take advantage of over 30 seminars** featuring industry leaders who will provide practical strategies to support your entrepreneurial enterprise and fuel your business success

**Power up your business network...**attend a networking reception and establish valuable contacts and explore new business opportunities with other home-based entrepreneurs

*Exhibitors*

**Exhibitors Note: Distribution and selling opportunities...**reach over 13,000 home-based entrepreneurs and telecommuters

*Free Pass*

### BE OUR GUEST...REGISTER TODAY!

**Economize...save the \$15 admission fee.** Register **before March 7th** to receive your **FREE** guest badge in advance by return mail. **After March 7th**, present this coupon at the door for free admission. **Any questions? Call (416) 869-0141**

To pre-register, **FAX** your business card or your name and address to (416) 869-1660 or **MAIL** to: Corporate Events Management, One Toronto Street, Suite 803, Toronto, Ontario M5C 2V6

# newsbytes

EXCLUSIVE NEWS

## Software Suites More Popular

SAN JOSE, CA — For the first time ever, a business application suite has made it into the number one slot in market research firm Dataquest's preliminary worldwide personal computer (PC) application top 10 list of software titles. In 1993, in addition, the market for PC software suite applications saw the phenomenal growth rate of over 200 percent reaching US\$844 million.

The number one software title was the suite of applications bundled together as Microsoft Office for Windows, kicking word processing application Microsoft Word for Windows out of the application software lead.

Dataquest expects the suite application market will easily surpass the \$1 billion mark in 1994. Microsoft realized \$762 million in worldwide revenue from software suites, while Lotus earned \$68 million and Borland made \$14 million.

Contact: Dataquest, 408-437-8312, fax 408-437-0292

## Oh Waiter . . .

BOYNTON BEACH, FL (NB) — At some point, almost everyone has been in the situation of having to wait in a restaurant for the waiter's attention. But now, at a couple of restaurants, customers are flailing their arms no longer.

Motorola's new Table Paging system, being beta tested at two outlets in the Friday's restaurant chain, uses the inventive vehicle of a sugar, salt and pepper caddy to let patrons discreetly send messages to restaurant staff.

The system revolves around a small button, built into the caddy, that, when depressed, causes the waiter's pager to vibrate and display the table number requesting attention.

Contact: Motorola Customer Owned Paging Services, 800-382-9336;

## Unitel Comes To Manitoba

WINNIPEG,— Unitel Communications Inc., has begun offering long-distance telephone service in competition with the provincially owned Manitoba Telephone System in Winnipeg and Brandon, Manitoba.

Manitoba becomes the eighth province served by Toronto-based Unitel, leaving only neighboring Saskatchewan and Alberta without competition in long-distance service.

The company got permission to begin offering long-distance service early in 1992, and launched its first offerings later that year. The original regulatory decision did not cover the three prairie provinces because their telephone companies were still regulated by provincial authorities. Since then, Uni-

tel has reached an agreement to offer service in Manitoba.

The Canadian Radio-television and Telecommunications Commission (CRTC) has also given the company permission to serve Alberta, but because Unitel is unhappy with the amount it must pay to local tele-

phone companies there to subsidize local service, company officials say it is possible only large national customers that deal with Unitel in other provinces will be offered service in Alberta.

New telecommunications legislation passed earlier this year gave Saskatchewan a

five-year grace period to adjust to federal regulation, making it unlikely long-distance competition will appear there until late in the decade.

Contact: Unitel, 800-959-9595

# The World's FASTEST CD-ROM.

Yes it is the world's fastest... and no one else comes close!

## DRM604X

Pioneer's DRM-604X, featuring its exclusive *Quadrspin* technology, has jumped past double speed drives to a new transfer rate of over 600 KB/sec. That's four times the speed of standard drives and twice the transfer rate of double speed drives.

### DATA TRANSFER RATE (KB/SEC)

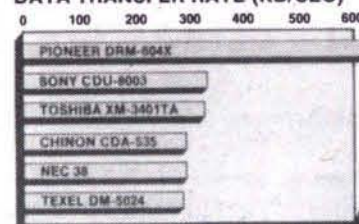

In an independent Test\*, Pioneer ranked number one in overall performance. The DRM-604X searched databases, retrieved files and read CD's faster than any other drive.

### Highest Capacity

Not only is this drive fast, it's also the industry's only 6 disc mini-changer.

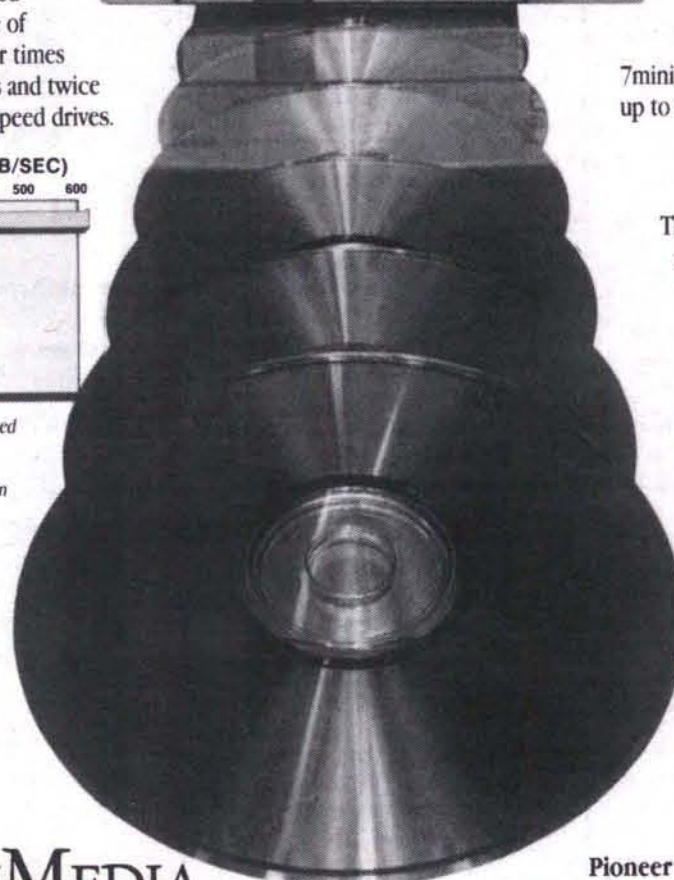

## \$1599

While Quantities Last

The DRM-604X holds 6 CD's and can change CD's in an amazing 5 seconds. If you need more than 6 CD's you can manually change magazines or daisy chain up to 7 mini-changers to automatically access up to 42 discs and more than 5 million pages of data.

### Best Flexibility

The DRM-604X is compatible with most operating systems and hardware platforms and has the latest features including multisession technology. Multisession makes it 100% Kodak Photo CD compatible and ready for new applications in the future.

For a fast response, call Pioneer at 1-800-LASER ON.

**MULTIMEDIA EFFECTS**

To Order Call (416) 502-3942  
Or Fax (416) 502-1593

Pioneer New Media Technologies, Inc.  
**PIONEER**  
The Art of Entertainment

# newsbytes

EXCLUSIVE NEWS

## Worldwide PC sales Growing

SAN JOSE, CA — According to Dataquest's preliminary 1993 worldwide study of personal computer (PC) market share, Compaq has the largest share increase of all PC makers. Apple Computer was number two and IBM, still number one in market share among PC makers, made the first gains in its market share since it began losing its hold in 1989.

Compaq nearly doubled its revenue and increased its market share by 3.9 percent. The top five PC makers — IBM, Apple, Compaq, NEC, and Dell — gained 6.2 percentage points over last year's figures to hold 44.1 percent of the total PC market. The percentage breakdown of the \$66,265 million PC market shows that IBM holds 13.6 percent, Apple has 11.0 percent, Compaq has 10.0 percent, NEC has 5.7 percent, and Dell holds 3.8 percent.

Contact: Dataquest, 408-437-8312, fax 408-437-0292

## Computer Dummies In High Places

MENLO PARK, CA — At least half of US and UK executives lack basic personal computer (PC) skills, according to a study conducted by Robert Half International. The reasons cited ranged from "fear" to "time pressures."

The survey asked 100 top executives in both the United States and the United Kingdom, "In your opinion, what percentage of the nation's top executives is not computer literate?" The answers were 55 percent in the US and 51 percent of UK executives lack computer skills.

PC industry guru Peter Norton once related a story about the time he asked an IBM executive if the executive had trouble installing OS/2. The executive replied, "I don't use a computer — I have a secretary."

Reasons cited for computer illiteracy among executives include: computer skills considered a low priority; intimidated by

computers; discouraged due to the learning curve involved; resistance to change; and a lack of time.

Contact: Robert Half International, 415-854-9700, fax 415-854-9735

## DEC Canada Gets New Boss

TORONTO, — Digital Equipment of Canada Ltd., got a new boss in January. Ken Copeland has stepped down as president and chief executive of the Canadian subsidiary of Digital Equipment Corp., to be succeeded by Ronald Larkin.

Larkin comes to the post from Australia, where he was for two years managing director of Digital Equipment Corp. (Australia) Pty. Ltd. Before that, he was Copeland's right-hand man as vice-president of sales and marketing at DEC Canada. He came to DEC from IBM Canada Ltd. in 1987.

Copeland, who has headed the Canadian subsidiary for nine years, will remain on DEC Canada's board of directors.

Contact: Digital Canada, 416-597-3162)

## Pentium, 486 Price Cuts Coming

SANTA CLARA — Intel, the major manufacturer of the brains of IBM and compatible personal computers (PCs), has announced price cuts for the second quarter of 1994, ranging from 14 to 18 percent on its Pentium and high-end 486 microprocessors.

The microprocessor giant claims the Pentium is moving faster into the mass market channel than any other chip introduced in the company's history. This is despite reports that the Pentium is not moving into the retail channels as fast as was first anticipated. Greater capacity for building Pentium processors on the part of Intel is being credited for the lower prices.

Contact: Intel, 408-765-1435, fax 408-765-1402

## British Telecom Canada Offers Video

TORONTO — Claiming to offer greater ease of use and installation than personal computer-based videoconferencing, but greater portability and lower cost than room-sized systems, BT Canada has launched its VC7000 portable videoconferencing unit.

BT Canada, a subsidiary of British Telecom, said that the system will let small groups of users take part in remote meetings.

The self-contained unit has a camera and a nine-inch color monitor.

Contact: BT Canada, 905-602-0444, fax 905-602-0491

## Canada's Stentor Plans Budget Cuts

OTTAWA — Stentor, the national consortium of Canada's regional phone companies, is planning budget cuts in 1994 and may reduce its work force.

Company spokeswoman Cherry Foster confirmed that Stentor, made up of nine regional telephone companies, will cut its budget by an unspecified amount in 1994. The Financial Post, a daily business newspa-

per in Toronto, recently reported that Stentor's 1993 budget was C\$300 million. Foster said the number was "a guess" on the Post's part and Stentor does not make budget figures public, but she did not specifically deny the figure's accuracy.

Contact: Stentor, 613785-2850

## Nintendo Turns To RISC

TOKYO — Three major Japanese electronics firms have decided to supply their 64-bit micro processing unit to Nintendo. Using the powerful new chip, Nintendo plans to create a next generation of video game machines.

According to reports circulating in Japan, Nintendo is developing a powerful video game machine based on a 64 bit reduced instruction set computing (RISC) processor. Sources suggest that the as yet unnamed machine, which will be released some time in 1995, will be the successor to the Super Famicom series of games machine, using chip technology supplied by NEC, Toshiba and Sharp.

Contact: Nintendo, +8175-541-6111, Fax, +81-75-531-1820

## ZyXEL Modem/Fax with Voice

Ultra High Speed upto 19.2Kbps Data & 14.4Kbps Fax

- Maximum Throughput Speed up to 76.8Kbps
- Includes Zfax 3.0 VoiceFaxData Software with up to 1,000 mailboxes, fax on demand, Caller ID log, etc.
- Caller ID and Extended Distinctive Ring
- Full Featured Windows Software Available
- Current Owners Call for Your Free Zfax 3.0 software



To make Your Wise Investment, call 416-534-1508 for a dealer near you.



4319 Fraser St.  
Vancouver, B.C.  
V5V4G4



### Price Blowout!!

|                                |          |
|--------------------------------|----------|
| OS/2 for Windows .....         | \$64.95  |
| Borland C++ OS/2 .....         | \$178.95 |
| Stacker for OS/2 .....         | \$179.95 |
| Faxworks for OS/2 .....        | \$149.95 |
| IBM C/C++ for OS/2 .....       | \$Call!  |
| WordPerfect for OS/2 upg. .... | \$159.95 |
| Lotus SMARTSUITE/2 .....       | \$Call!  |
| Lotus AMI Pro OS/2 .....       | \$Call!  |
| Quickswitch for OS/2 .....     | \$Call!  |

We'll demo what we sell and you can try before you buy.

## Software Solutions Showroom

We're BC's EXCLUSIVE Apogee Retailer for Registered Versions of their Smashing Games

**DOOM**  
Registered versions available

Multimedia & Muzak  
SOUND Canvas SC-55mkII



Roland equipment \$CALL

### NEW GAMES!!

|                                     |         |
|-------------------------------------|---------|
| Blake Stone .....                   | \$74.95 |
| Duke Nukem 2 .....                  | \$44.95 |
| Halloween Harry .....               | \$39.95 |
| IndyCar Racing .....                | \$58.95 |
| Privateer .....                     | \$68.95 |
| AD&D: Dark Sun .....                | \$69.95 |
| Aces Over Europe .....              | \$58.95 |
| Police Quest 4/Quest for Glory 4 .. | \$Call  |

Hours: Mon - Thurs 11am - 6pm  
Fri - Sat 11am - 7pm



We Demo  
Roland SoundCanvas  
Gravis Ultrasound  
Pro-Audio Spectrum  
Sound Blaster Pro



For Software (604) 879-3563 • BBS (604) 264-9859

# training

## Q&A

BY GRAEME BENNETT

**Q:** is it feasible to convert the 750 fonts and clip art that come with the PC version of CorelDRAW for use with a Mac?

**A:** The answer is...maybe. Initial tests were very encouraging. Using Ares Software's excellent FontMonger, an entire batch of any number of PC fonts converts with three clicks of the mouse, names are set automatically, and conversions are good.

The only sort-of-problem is that the screen bitmaps (i.e., used only if WYSIWYG menus is enabled) are pretty ugly. They could be hand-optimized, though.

Overall, it works excellently. Clip art is a little less conclusive. It is possible to export the art from CorelDRAW in a variety of Mac-compatible formats (PostScript printer users should use EPS or Illustrator formats, while non-PostScript users could export the files as PICT files or TIFF bitmaps).

The only trouble with Corel's EPS and Illustrator output is that it lacks the screen display that allows Mac users to view the PostScript file on-screen. Well, there is an EPS preview if you call a black blob a "preview."

This can be solved by using TechPool Software's Transverter Pro to process a batch of EPS and/or Illustrator files to automatically add the previews, but the resulting files don't print from some programs (QuarkX-

Press, for example.) Argh!

**Q:** My new laser printer only prints part of a picture on the page. What's wrong?

**A:** Just because a printer is CAPABLE of printing at 300 or 600 dpi (etc.) doesn't mean that it's got enough memory to do so. You may not be able to print a full page at the maximum resolution of your printer without springing for extra RAM for your printer. At the price of memory these days, that can cost a few hundred dollars extra.

Here's why. A 300-dpi printer works out to 90,000 dots per square inch. Obviously,

that requires a megabyte or more of printer memory to hold a full page worth of information. Note that a few laser printers, such as Hewlett-Packard's low-cost LaserJet 4L, use a special image-compression technique to allow printers with only 512K of memory to print full pages of text or graphics.

Ironically, lower-cost ink-jet and dot-matrix printers don't have memory problems either, because they can print an image-line-by-line. Printing a single line at a time requires little or no printer memory. A laser printer, in contrast, must image the entire page at once.

Continued on page 84



**City and Guilds Institute of North America**  
HOME STUDY COURSE for  
**COMPUTER PROGRAMMER**  
SYSTEMS ANALYST  
C, UNIX & DOS  
**CMS TRAINING**  
(416) 440-9978

City and Guilds of London Institute      City and Guilds of North America

**COMPUTER COURSES**  
PC & MAC

For everyone from the home user to the professional

- MS Word    •WordPerfect    •Lotus    •Excel
- dBase    •MS Access    •MS Works    •PageMaker
- QuarkXPress    •Illustrator    •Freehand    •CorelDraw
- MS Works    •System 7.XX    •Windows    •DOS

PC & MAC Installation & Maintenance  
User Friendly Organization    (905) 889-5311

**AutoCAD BY CORRESPONDENCE**  
Student Edition of AutoCAD available.

For a free brochure write or call:

ACET Department, SAIT  
1301 - 16 Avenue NW  
Calgary, Alberta T2M 0L4  
Phone: (403) 284-7202  
Fax: (403) 284-8812



Southern Alberta Institute of Technology

**Master Your Mac!**

Master your Mac with MacAcademy Training Videos and Personal Training Systems Interactive Audio Tapes \$9.95/for 2 week rental. From \$59.95 to buy (Plus Taxes, S&H) 1-800-667-8073 outside Ottawa. In Ottawa call 613-729-0234. Satisfaction Guaranteed. From TRAINING NOW—FOR TOMORROW. In business since 1993 & growing.

**John W. Dodson, M.Ed.**

126 Hamilton Avenue North      Tel: (613) 729-0234  
Ottawa, Ontario K1Y 1C2      Fax: (613) 729-6615

**TECHNICAL COURSE FOR NON-TECHNICIANS**  
(Hands-on Computer Hardware Software support course)

Part 1  
Assemble, Upgrade, Trouble Shoot, Repair Computers \$150

Part 2  
Install CD Rom, Tape Backup, Fax Modem, Sound Card, etc. \$35

Part 3  
Software Installation & Trouble Shooting \$65

**MICROBUS**  
3428 Sheppard Ave. E. Scarborough, Ontario (NE of Warden & Sheppard)  
(416) 321-0895

Autodesk.  
**Generic CADD**  
Version 6.1  
3 days HANDS-ON TRAINING SEMINAR  
(for a group of six)  
Only \$475 GST extra

**100% AutoCAD compatible!**

- Drawing & editing tools
- Up to 256 layers
- Read/write in .DWG files
- Import/export in .DXF
- Import/export generate Bill of Materials
- Generate 3D drafting from 2D drawings

**CALL FOR DETAILS!**

**Xemex**  
(416) 739-8973

**SoftTrain Institute**

West Campus: 234-8830      5415 Dundas St. W., # 104 (At Kipling Station)

Central Campus\*: 975-0522      615 Yonge St., Suite 500 (at Yonge & Bloor)

|   |                            |                                     |
|---|----------------------------|-------------------------------------|
| <b>Long-Term Programs (3-6 months):</b>   | <b>Short-Term Courses:</b> | <b>Short-Term Courses (cont'd):</b> |
| Computerized Office Specialist            | WordPerfect 5.1    \$139   | Excel for Win.    \$139             |
| Computerized Bookkeeping Specialist       | WordPerfect/Win.    \$139  | Novell    \$199                     |
| Micro Computer Specialist                 | WordPerfect 6.0    \$169   | Word for Win.    \$139              |
| WordProcessing Operator                   | Lotus 1-2-3 2.2    \$139   | CorelDraw! 3    \$139               |
| Data Entry Operator                       | Lotus 1-2-3 3.1    \$169   | OS/2    \$199                       |
| CAD Specialist                            | Lotus 1-2-3/Win    \$169   | PC Assembly    \$199                |
| DeskTop Publishing Specialist             | Typing/Keyboard    \$ 79   |                                     |
| Customized Full-Time Programs             | Typing Refresher    \$ 99  |                                     |
| *Computerized Office Specialist (Diploma) | Data Entry    \$ 79        |                                     |
|   | DOS    \$ 99               |                                     |
|   | Windows 3.1    \$ 99       |                                     |
|   | PageMaker 4.0    \$139     |                                     |
|   | Harvard Graphics    \$139  |                                     |
|   | dBase III Plus    \$139    |                                     |
|   | dBase IV    \$139          |                                     |
|   | Programming/C    \$199     |                                     |
|   | Programm./QBasic    \$199  |                                     |
|   | Essentials Acctg.    \$129 |                                     |
|   | Simply Accounting    \$ 95 |                                     |
|   | ACCPAC + 5.0 GL    \$ 95   |                                     |
|   | ACCPAC + 5.0 AR    \$ 95   |                                     |
|   | ACCPAC + 5.0 AP    \$ 95   |                                     |
|   | ACCPAC + 6.0 GL    \$154   |                                     |
|   | ACCPAC + 6.0 AR    \$154   |                                     |
|   | ACCPAC + 6.0 AP    \$154   |                                     |
|   | ACCPAC + 6.0 PR    \$154   |                                     |

**Central Campus only**  
**Introductory courses**

WordPerfect  
Lotus 1-2-3  
Keyboarding  
DOS

**\$89**  
per course

Instructor-led / hands-on  
2 days or 4 evenings  
Maximum 6 students in a class  
Tuition includes all materials  
Certificate upon completion

\*Approved as a Private Vocational School under the Private Vocational Schools Act of Ontario. If you are over 45 years of age and have recently laid off you may qualify for government assistance.



# SOFTWARE

# WORLD

## CONFERENCE & EXPOSITION

MARCH 8-10, 1994 • TORONTO

**SOFTWARE WORLD...**  
*the most extensive  
 Canadian computing  
 event returns to Toronto  
 stronger than ever with  
 CLIENT/SERVER WORLD  
 at its side.*

**10 Conferences  
 in One Event**

**Over 100 Industry  
 Experts**

*Sponsored by:*



### Software World

- Business Software Re-Engineering
- CASE & Application Development
- Object Oriented
- Database Technologies
- Workgroup Technologies

### Client/Server World

- Managing a Client/Server Environment
- Developing Client/Server Applications
- Networking and Operating Systems
- User Spotlight
- Client/Server Databases

**For More Information  
 or a FREE Brochure  
 and a FREE Gift, Call  
 DCI at 508-470-3880**



**Featuring Only 1994 Canadian Appearance**  
**Jim Manzi presenting**  
**"The Return on Workgroup Computing"**

Manzi is the chairman, president, & chief executive officer of Lotus Development Corp. Manzi sets the company's strategic direction and priorities and is a principal architect of Lotus' Working Together strategy, which focuses on integrating applications, platforms, and people.

### Conference Chairmen

Dr. George Schussel  
 Roger Burlton  
 Ed Yourdon

### Co-Sponsors:

Amdahl Canada, Ltd.  
 IBM Canada  
 Lotus Development Canada  
 Powersoft Corporation  
 Process Renewal Group  
 Uniface Corporation  
 Unisys  
 WATCOM

### And . . . The Exposition

Featuring over 150 of the  
 Leading Software Companies  
 and Special Lotus NOTES®  
 Partner Pavilion

**Special Presentation by**  
**Chris Date, Codd & Date**  
**Only 1994 Canadian Appearance**

### Plus:

Larry R. DeBoever  
 Christine Comaford  
 Jeff Tash  
 Rich Finkelstein  
 Art Benjamin  
 Janet Perna  
 Dave Thomas ...and many more.

# MULTI-MEDIA TRAINING

begins with

## COMPUTER GRAPHICS

Computer technology has changed the design world forever.

To keep pace, you need up-to-the minute training.

**OUR COMPUTER GRAPHICS PROGRAM** will get you started, or sharpen your skills...FAST!

- Short 10-week courses
- Small classes • Latest software
- Practising professional Instructors

Full & Part-Time  
Classes start

**March 21, 1994**

**Apply Now!**

**922-3666**

International Academy  
of Merchandising & Design  
31 Wellesley St. East  
Toronto, Ontario  
M4Y 1G7



### Q&A

Continued from page 82

For example, we have a printer here at *The Computer Paper* that we recently upgraded to 1200 dpi. We can set the resolution to any one of several resolutions — 600, 960, 1200, etc. — from the LCD front panel. We'll be merrily printing at 1200 dpi and when we come to a job that really stretches the margins of an 11x17 page, it simply runs out of memory. Remember that a 11x17 page at 1200 would require 32MB of memory just for the page image...only leaves 8MB for operating system, fonts, the file itself, networking buffers, etc.

It's nice to have hi-res capability, but graphics-intensive pages will have to be printed at a lower resolution until you install extra memory in your printer. ■

**ADAPT** Hands-on Training  
SOFTWARE TRAINING SPECIALISTS

6 hour seminars in ...  
**WORDPERFECT - MS-WORD**  
**LOTUS - EXCEL - WINDOWS**  
**CORELDRAW - PAGEMAKER**  
**VENTURA - ACCPAC SIMPLY**  
**- DOS**

Your Premises or ours!

**283-4932**  
Call today for free course outlines

# training.....

## Immersion school offers careers

"The country is in recession, but our business is doing great," says Doug Morley, President of The Institute For Computer Studies. "People out there can't find work or want to change careers and we get them both. It's hard to keep up with the demand."

Based in north Toronto, the school draws students from right across Canada. It pioneered the concept of full-time immersion learning — up to 70 hours a week for five months — so students could quickly learn the skills of computer programming and enter the industry.

The institute was started by Honeywell Bull, which was trying to divest itself of the school. Three years ago Morley, a 24-year employee of the company, bought it and went out on his own. Since then Morley has known only success.

He streamlined the operation and began focusing on the students as 'customers'. Since 1990 The Institute has seen growth of 400%. This year it launched a Commercial

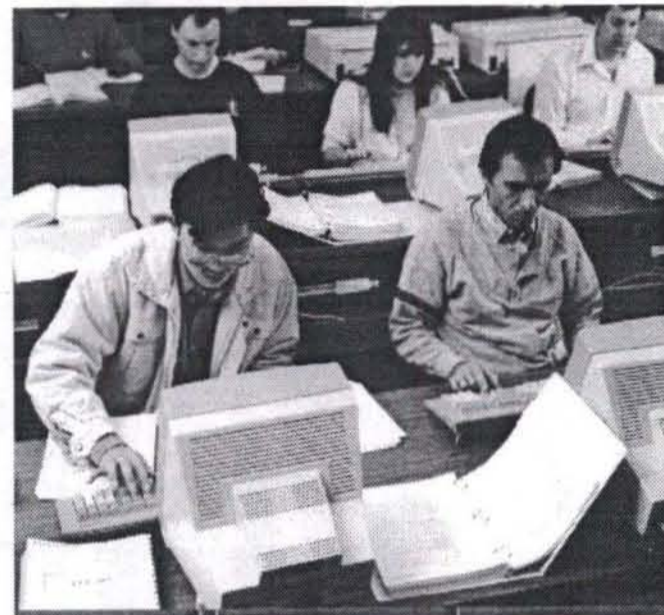

Education Centre for commercial training and also opened a new school in Boston.

Students hail from all walks of life and Canada Employment and Immigration Corporation sponsors a number of people each term. Recent grads include an opera singer who is now a programmer analyst with a bank, a 57-year old civil engineer who joined an engineering consulting firm, and a diplomat who is working with an organization that collects donations for the Third World.



**STARLIGHT INC.**  
Software Training Since 1986

## Free Luncheon Seminar

Find out more about the planned changes to the Novell CNA, CNE, ECNE technical support programs.

Understand what you're getting when you buy Novell Authorized Education.

Date: Friday, February 18, 1994

Time: 12:00 to 2:00 p.m.

Location: StarLight Inc.  
Toronto, Ontario

Guest Speaker: Lynne Strom-Nielsen,  
Novell Canada Inc.

To Register: Call Jessie Grant at  
(416) 971-9053

**\* Pre-registration required, attendance limited \***

Let us help you get specific skills that are in demand today!

## Information Highway Leads To Toronto

BY GRANT BUCKLER

TORONTO (NB) — A number of high-profile speakers, including Canadian Prime Minister Jean Chretien and US Vice President Albert Gore, have been invited to a conference on the information highway set for Toronto in early February.

The conference — Powering Up North America — is being organized by the Information Technology Association of Canada (ITAC), a group of the larger computer and telecommunications companies in Canada, and the Canadian Advanced Technology Association (CATA), whose members are largely smaller, Canadian-owned high-tech firms.

Neither Chretien nor Gore has officially accepted the invitation yet, but ITAC spokesman Barry Gander said the organizers are optimistic. He said the lineup of other speakers, including a number of prominent names in the technology sector, should interest Gore, who has been an outspoken proponent of the information highway concept.

The information highway, besides being the fastest-rising buzzword of 1993, is an umbrella term for a high-capacity communi-

cations network that would carry data, voice, and video. In the US, Gore has backed a National Information Infrastructure program meant to help develop this kind of capacity.

Speakers slated for the conference, to be held at the

Metropolitan Toronto Convention Center February 1 and 2, include: Rudiger Dornbusch, professor of economics at the Massachusetts Institute of Technology and a frequent speaker on trends; author and futurist George Gilder; Nicholas Negroponte and Russel Neuman of MIT's Media Lab; Bill Murphy, chair of the US' National Information Infrastructure Testbed; Don Tapscott, co-author of the recent technology trends book *Paradigm Shift*; former Federal Communications Commission (FCC) Chairman Alfred Sikes; and heads of assorted Canadian and American high-technology companies.

About 1,000 people are expected to attend, Gander said. Registration costs C\$895 for members of ITAC or CATA, and C\$995 for non-members.

Contact: Powering Up North America 416-862-9067, fax 416-862-2238

# USER GROUPS

**AMIGANAUTS MEETING** On the second Sunday each month, 6-8 p.m., at 2975 Don Mills Rd. West, Oriole Community Resource Centre, 2nd floor, Games Rm. Full Amiga users support, monthly tutorials and presentations of latest software and hardware for the Amiga and, coming soon, a BBS.

**ANIMATORS' GROUP** — Interested in the creation of 2-D and 3-D animation? Zimgraphics Ltd. offers hands-on training and memberships for those interested in computer graphics. For more information call (416) 929-8155.a

**CANADA ROUNDTABLE ON GENIE** — Nightly and weekend meetings. Discuss Canadian Politics, Sports, Canada-U.S. Relations, Travel, Entertainment. Try En Francais, which includes a French tutorial. More info? 1-800-638-9636.

**CANADIAN COMPUTER GRAPHICS ASSOCIATION** — CCGA's mission is "to provide education and information in computer graphics technology and its applications." At special events members are informed of developments in the industry, and provided a networking forum to develop career and business opportunities. Additional benefits include: insurance, newsletters, subscriptions, employment liaison office, and annual art & design competition. CCGA, 2175 Sheppard Ave. E., Suite 110, Willowdale, Ontario, M2J 1W8. Fax: 491-1670 Tel: 491-2886.

**CANAM COMPUTER CLUB** - for serious computer hobbyists. Breakfast meetings are held every Saturday morning at Obies Restaurant in Warden Woods Mall, Scarborough. The Club has a sister group in the U.S. where info., ideas and help are exchanged. Membership is free but a full breakfast is \$5.00 including gratuity. For info. call Cy Leonard at 288-0318.

**CASE SPECIAL INTEREST GROUP** — A special interest group is being formed to help people interested in learning more about CASE. The purpose is to provide a forum where members may share their experiences. Experienced users or those interested in CASE call Joe Da Silva at 252-1408, or Rob Beckman 928-2694.

**CASE** — Computer Aided Software Engineering is open to anyone interested in being tool and technology independent. 1-1 1/2 hours, monthly scheduled meetings. Vendor presentations as well as individual. BBS 497-5263, (log on if MIS Affiliated messages, into Tech 2nd category called CASE). Contact Joe Da Silva at 252-1408 or Rob Beckman at 928-2694.

**CLIPPER DEVELOPERS ASSOCIATION OF TORONTO** will hold its Feb Meeting on Thurs. Feb. 3, 1994 at the North York Central Library in North York at 7:00 pm. Rod Da Silva will speak on Compiler Construction with Clipper. For details call Mike Parente (905)336-5191 ext. 447.

**CLUB CUBASE** — Toronto area users of Steinberg Software products, especially their powerhouse sequencer Cubase, now have a forum to share information and develop skills. Club Cubase meets at 7:30 pm on the last Monday of every month, in Room C426 at the Casa Loma Campus of George Brown College - 160 Kendall Ave. For more information contact Club Cubase at 62 Hamworth Drive, Willowdale, ON, M2H 3C2 or call 496-9905.

**CLUB MAC COMPUTER GROUP OF ONTARIO** — All Mac users, Macintosh OS & related issues, meets 2nd Tuesday, Michener Institute, 222 St. Patrick St., Toronto, 7 pm to 10 pm, infoline 462-1702.

**COMPUTER TRAINERS' NETWORK** — A group of teachers, tutors and consultants who meet the first Thursday of every month to discuss training or computer-related issues. Meeting format consists of refreshments, business portion, guest speaker and memberships available. Location: 121 King St. W., 24th Floor, Toronto, Ontario. For more information please call Veronica of Vision Computer at (416) 323-0406.

**CYBERPUNK RESEARCH LABORATORIES** — Merry hackers in search of picturesque, mountains, RAM and fairytales. For further data write c/o CyberPunk Research Labs. - Seneca College of Communication Arts, 1124 Finch Ave. West, North York ON M3J 3J3.

**ELECTRONIC GAMES PLAYERS' ASSOCIATION (EGPA)** — EGPA announces the start of their Canada-wide search for computer and video game players interested in swapping their used games. As a member of the EGPA, individuals will be able to exchange game software. Members will also be able to buy used games without a trade. Membership available for the first year with an annual renewal. If you are interested in joining or would like more information, please send \$1 to cover postage and handling to: EGPA, 292 Patricia St., North Bay, Ont., P1B 7Z3. The one

dollar is applied to your membership fee.

**IRMAC** — Information Resource Management Association of Canada: dedicated to data management, IRM, data dictionaries, CASE, and strategic planning in the corporate environment. Monthly meeting in Toronto, Ottawa, and Victoria. (416) 960-6508.

**K.R.D.** — 1995 (The Kidstuff Reunion Drive Group for 1995) At 144 Gillard Ave., Riverdale. Tel: 461-1343. Call for meeting dates 11AM Saturdays. Group's focus is to collect 1975-6 Canadian pennies in order to reassert interest by signing a petition to reinstate the 1975-76 CTV Show "Kidstuff". Komputer Kidstuff 1995?? 2005?? Ask for Jeffrey Leitner (416) 461-1343.

**KW-MUG** — 376 Peel Street, New Hamburg, ON, N0B 2G0, (519) 662-2627. Focus: Public domain distribution; reviews of current software; meetings variable, no fees.

**LOGIC** — An Independent Apple User Group: Provides a support and information network to users at all levels. LOGIC accomplishes this by: holding monthly meetings, hosting Special Interest Group meetings, providing an electronic bulletin board, publishing the Maple Orchard magazine (free to members), and maintaining an extensive library of shareware and public domain software. Meetings 1st & 3rd Tuesday of the month, North York Centre, 5110 Yonge St., in the Memorial Hall at 7:30 pm. Messages (416) 323-0828 BBS (416) 487-9771.

**METRO TORONTO ADAM GROUP (MTAG)** — Supporting ADAM, CP/M-TDOS Users contact: (416) 424-1352 or write to: P.O. Box 165, 260 Adelaide St. E., Toronto, ON, M5A 1N0. Meetings 2nd Monday of each month, 1485 Albion Rd (Community Centre) and 4th Sat. each month at the Pope Ave. Community Centre. Bi Monthly newsletter.

**MISSISSAUGA COMPUTER CLUB** - (M.C.C.)... Supporting IBM-PC, Macintosh, and Amiga systems. Presentations, Demos, Raffles, SIG's, and "LOADS" of shareware... also a monthly newsletter. "ALL WELCOME", if interested or further information please call Robert Brower (President) at (416) 890-4503 or "TOTAL ACCESS BBS" at (416) 568-5294... Meeting held the last Tuesday of each month.

**NEXT USERS GROUP** — NeXT computer support, 2nd Thursday, Toronto Western Hospital, corner of Bathurst & Dundas, yellow elevator to 6th floor, 7:00 pm, Daniel O'Connell (416) 365-1899.

**NORTH AMERICAN DESKTOP** - A computer users group for PC and Apple. Useful, constructive exchange of ideas, business services and information through presentations, discussions and networking at an affordable price. Bi-monthly. For more information call (905) 889-5311.

**PCCT (PERSONAL COMPUTER CLUB OF TORONTO)** — PC users, 3rd Tuesday, St. Gabriel's Community Centre, 672 Sheppard Ave. E. (2 blocks East of Bayview, North side), North York, 7:00 pm; membership includes shareware, BBS, special interest groups (SIGs) & workshops. Information (416) 244-6786.

**TAF - TORONTO ATARI FEDERATION** - XE/ST/Falcon computers. 300 members. BBS. Newsletter. SIGS for MIDI,DTP, General and more. Meets 7:30pm. Third Thursday of month in North York Memorial Community Hall in the N.Y. City Centre Library building, 5110 Yonge St. at Park Home. BBS - (300-16.8) 235-0318. Infoline (416) 22-55-823 CALL-TAF.

**TANUG - Toronto Area Network Users Group** - Next meeting to be held at the Education and Meeting Centre of the Canadian Bar Association - Ontario, 2nd floor, Salon 1, 20 Toronto St. The evening event is a training program on the subject of "Tuning Network for Performance". Registration starts at 5:30 - meeting from 6 pm - 9 pm. A cold buffet will be served. Admission is \$20. Pre-registration is advisable. 269-0940.

**THE CANADIAN AUTODESK MULTIMEDIA USER GROUP** — Interested Users of Autodesk Multimedia products are invited to call Pia Zimperi at (416) 929-8155.

**THE CANADIAN INFORMATION PROCESSING SOCIETY** - presents the following meetings at the Toronto Board of Trade, 3rd Floor, at 6:00pm. Jan 19, Jan 20, Feb 17. For further information call Brian Gilbey 351-6283.

**THE COMMUNICATION NETWORK** - Join our Social Network/Support Group for SHY people and enhance your Social and interpersonal skills. Participate in weekly organized social and cultural activities. Weekly meeting from 7-10pm. Pre-registration is required. Call for more info at 851-6696 or 851-2980.

**THE DURHAM P.C. USERS' CLUB** - sup-

ports local computer enthusiasts with monthly meetings and a newsletter, a software library and many special interest groups. Meetings on second Thursday of each month at 7-10 pm (free admission). Meetings held at CAW Local 222 Hall, 1425 Phillip Murray Ave., Oshawa. Contact Barbara Rice at 416-434-7420 or Bruce Laycraft 416-728-9351.

**THE ELITE GROUP OF 3-D PROGRAMMERS** — (E.G.3D P) in association with L.T.P.D. Dedicated to Atari users. For more information write to L.T.P.D. c/o (E.G.3D P), 37 Montye Ave., Box #2, Toronto, Ontario M6S 2G8.

**TORONTO CHAPTER, THE SOCIETY FOR TECHNICAL COMMUNICATION** will hold its Feb meeting on Tuesday, February 15th at 7 pm. Our speaker, John Jacobi, will talk about CD-ROM: standards, trends and considerations for storing information on CD-ROM. Mr. Jacobi runs his own company specializing in CD-ROM preparation, reproduction and distribution. For info and exact location of meeting call Chris Mills (416)408-7690.

**THE TORONTO COLOUR COMPUTER GROUP** — meets on the 2nd and 4th Mondays of each month. For more information, call Larry Osborne at (416) 972-1809.

**THE TORONTO GUPTA USERS GROUP (TGUG)** - Open to anyone who is a user, developer or vendor of Gupta SQL database software. Meetings held in Feb, Apr, June, Sept, Nov each year. Contact Terry Lewis at 416-620-6565 X639 or 416-620-6913 (fax) for more info. Corp membership fee: \$50/yr (up to 3 employees); Single membership \$25/yr.

**TIMEX-SINCLAIR USERS CLUB** — All Timex and Sinclair Computers, 1st Wednesday of the month, 14 Richome Court, Scarborough, ON, M1K 2Y1, 7:00 pm. Demonstrations, bi-monthly newsletter. Voice Info. (416) 751-7559.

**TORCHI (Toronto Region Computer Human Interaction)** — Meets every second Wednesday of the month from 7:00 pm-10:00 pm. Members come from business, academic, and government to share interests in human use of computers, reflected in human factors, usability, Ergonomics, the user interface and many other related disciplines. For more information re speakers, topics and membership. We are the local chapter of Sigchi a part of ACM. Call M. Boshes (416) 448-2697.

**TORONTO APL SIG** — An educational and social organization concerned with the use and promotion of APL computer language. 4th Monday of each month at 6:30 pm (excluding the Summer) at BCE Place, 161 Bay Street, 10th Floor. Or write: Toronto APL SIG, Box 384, Adelaide Street P.O., Toronto, Ont., M5C 2J5. Contact Ben Best (416) 862-3193.

**TORONTO BORLAND USER GROUP**— meets 1st (C/C++), 2nd (Paradox) and 3rd (Quattro Pro) Thursdays of every month at 6 pm, 5:30 pm and 7 pm respectively. Meetings are held at Borland, 5001 Yonge St., 14th Floor. Learn about "PAL" (Paradox Application Language), Spreadsheets, C & Object Oriented Programming tips and traps. For membership and meeting details please contact Doug Campbell 496-2120. Free BBS (905) 271-9795.

**TORONTO USERS GROUP** — User members support of Intermediate CL. Next meeting is held on Sept. 22nd at the Howard Johnson Plaza at 400-401 Keele St. Please contact Wende Boddy at suite 2550, P.O. Box 77, Toronto Dominion Centre, Tor., ONT, M5K 1E7 for more information, or call (416) 607-2546.

**TPUG (TORONTO PET USERS GROUP, INC.)** — Commodore users (PET, 64/128, Amiga, CDTV, MS-DOS, etc.), meets Tuesdays (1st, 128; 2nd, Amiga; 3rd, GEOS; 4th, 64), York Public Library, main branch, 1745 Eglinton Ave. W. (near Dufferin), 7:30 pm; 3rd Thursday Alderwood United Church, 44 Delma Drive, Etobicoke, 7:30 pm, software library, newsletter & BBS, information (416) 253-9637. Also, a breakfast is being held in conjunction with the Men's Church Group of Alderwood United at 8:30 am on January 29, 1994 at 10 am. For info call John Easton 416-251-1511.

**TRACE** — Toronto Regional AutoCAD Exchange: Presentations on the last Tuesday of every second month. Held at the Malton Community Centre, 3540 Morningstar Drive. For details call Tim Lucas at (416) 750-9765.

**ZIM USERS GROUP** — Revival of the Toronto Zim Users Group. Emphasis on exchange of ZIM technical expertise in a friendly environment. Contact Fay Rakoff: Phone (416) 979-6216, or Fax (416) 979-4888.

# Toronto Stock Exchange Delays Automated Trading

BY GRANT BUCKLER

TORONTO, (NB) — Plans to close the equities trading floor at the Toronto Stock Exchange (TSE) and move to fully automated trading have hit another snag.

A pilot testing phase in which some traders will conduct live trades on the new electronic system was due to begin this month. Instead, it has been delayed until April. Jim Gallagher, executive vice-president of the exchange, said testing of the system found more bugs than expected and the problems are taking longer to fix than TSE officials had planned.

It is the latest in a series of delays for a conversion that was announced in February, 1992, and was originally supposed to have been complete last spring. Closure of the 115 year-old TSE trading floor, originally scheduled for March, 1993, was delayed at the beginning of 1993. It was then supposed to happen in the fall, but has since slipped back again.

Gallagher said the exchange now expects to close the floor before the end of this year, but would not give a more specific date. He said the exchange will probably announce a

new target date for closing the floor a month or two after beginning the pilot test.

It is important that all known bugs be worked out of the trading system before the live pilot begins, Gallagher said, because the traders will be conducting real trades. The pilot is intended to discover any problems that have not appeared in earlier testing before the exchange begins gradually moving its remaining traders from the floor to electronic trading from their firms' offices.

The shift will take place gradually because the exchange will need time to give traders adds training, Gallagher said. Although the exchange already trades some stocks through its Computer-Assisted Trading System (CATS), not all traders use this system and those that do will have to get used to a new workstation.

When the Toronto exchange announced in 1992 that it would close its trading floor, officials said it would be the first major stock exchange to dispense with floor trading entirely for stocks. The exchange plans to keep a small trading floor for futures and options. ■

TELL ADVERTISERS  
YOU SAW THEIR  
AD IN



## Order Mind-Expanding Material Through The Mail



The Computer Paper keeps you up to date with the latest news in the computer industry and gives you a local perspective.

Only \$24.95 a year. (GST Included)

Receive 12 Issues for only \$24.95 (USA-\$45 US, Overseas-\$90 CDN)

Send your cheque/money order to:

The Computer Paper 408-99 Atlantic Ave., Toronto, ON M6K 3J8  
or fax us your order (VISA/MC) (416) 588-8574.

Name: \_\_\_\_\_  
Address: \_\_\_\_\_  
City, Prov.: \_\_\_\_\_  
Postal Code: \_\_\_\_\_  
Telephone: \_\_\_\_\_

**Payment** (\$24.95)  
 Payment Enclosed (cheque/M.O.)  
 VISA/Mastercard  
Card #: \_\_\_\_\_  
Expiry Date: \_\_\_\_\_  
Name on Card: \_\_\_\_\_  
Signature: \_\_\_\_\_  
Date: \_\_\_\_\_

**Which Edition would you like?**  
 Ontario  Eastern  Manitoba  Alberta  B.C.  
Please sign here: \_\_\_\_\_

# CLASSIFIEDS

CLASSIFIED ADVERTISING IS FREE FOR PRIVATE INDIVIDUALS. For businesses, Advertising Rates are \$7 per line (40 characters). Send in your ad along with payment for the March Issue by January 31, 1994. (Personal Ads: an individual at a company can run an ad, but it must be for one-of-a-kind things for sale. FREE ads qualify to run for one month in the local edition only. Up to 2 ads per person maximum. All other ads classify as business ads and are subject to the \$7 per line charge.

## HARDWARE

| New or Used Computer Parts             |           |
|--|-----------|
| 4DX 33/40 local bus with 4 MB          | \$649     |
| 386 DX 40 with 4 MB memory             | \$295     |
| 286/386SX mother board                 | CALL      |
| 4 x 1 MB 70 ns memory                  | \$200     |
| 1MB VGA card                           | \$75      |
| ATI Ultra Pro VL 2 MB                  | \$400     |
| IDE HD                                 | \$18      |
| VL bus VGA 1 MB                        | \$115     |
| VL bus IDE I/O                         | \$25      |
| 200 Watt Power supply                  | from \$40 |
| 14 inch 0.39 SVGA monitor              | \$255     |
| 14 inch 0.28 SVGA monitor              | \$290     |
| used 20" SVGA monitor                  | \$950     |
| 200 MB hard disk                       | \$265     |
| Sound Card, CDROM & Harddisk           | Call      |
| Voice application development tool kit | Call      |
| Digiboard 16 port, BBS software        | Call      |
| New 9600 internal modem                | \$89      |
| Used 144 Fax modem                     | \$139     |
| Mac STFLC, Microphone                  | Call      |
| Toshiba Telephone System               | Call      |
| Security System for office             | Call      |
| Internal U.P.S                         | Call      |

For Enquiry call 538-1212 between 10-12:00 or leave a message

1Mx9 Simm memory (64 pin) Qty. 4, \$50 each, also 1Mx1 Dram Dip memory chips, Qty. 36, \$5 each. Call Thornhill 905-889-2617.

2 IDE Hard drives 42 Mb, Seagate 157A and Kyocera KC-40GA. Used only with home computer, no bad sectors. Call 494-4920.

2 Network Card \$25. Turtles Tools for IBM sample wave editor \$80. Commodore 1702 color monitor \$100. XT memory chips 640K \$10. Call 516-4950.

4 SALE Mac Plus /w 1 Or 4 Meg, 44 Meg Sysquest removable HD, 96/2400 Baud FM. Think C 6.0. Call Joe @ 783-9226.

4x1 Mb SIMMs: \$180. Canon BJ-10e with auto sheet feeder, parallel cable, full ink cartridge refill, 500 sheets, perfect condition!: only \$250. Dave (machine) 416-282-3712.

24 Pin Olympai AEG NP30/NP60 dot matrix printer and Adobe type manager program. All ready for Macintosh computer. \$160 obo. Ask for Miguel 267-9139.

40 MB Tape backup drive \$30. Commodore 1541 disk drive \$200. C64 computer (not working) \$50. Call 461-4875.

101 Enhanced Mitsumi keyboard for XT, AT & PS/2. One year old, good condition \$30-40 obo. 251-2996.

120 Meg 15 ms IDE Hard drive for sale. \$180. It's a Seagate drive too! Call Steve at 538-3322.

170Mb-H/D - 1 year + valsoft. Loaded. 324-8372.

286-Turbo, 40MBHD, 1MB RAM, 1.44FD, mono card Panasonic wide carriage printer-KXP1595. \$525. Call Gus at 755-1101.

286 Computer 80 Meg/HD, 2Meg RAM DOS 5.0, Windows, MSWORD. SVGA card + monitor. \$550. 1 250 RLL HD, Controller. \$150. Call 905-888-9052.

286 Motherboard from Tandy 3000-640K \$60. EGA/CGA card \$30. 360K FDD \$20. 3270 emulation card \$200. Call 946-8398.

386 DX22, 4M RAM, 42M Conner IDE HD, Magus MB, ATI VGA, 1.44 floppy, 251P1G ports, mouse, keytronic keyboard, case with 230W P.S., \$580. Call Thornhill 905-889-2617.

386 DX40Mini Tower, 1.2 FDD, 40MBHD, NEC-Color SVGA monitor, Fax board, Panasonic wide printer. \$1050. Call Gus 416-755-1101.

386 SX16 motherboard - \$50, 387 SX 16/20/33 - \$50. Call Leck at 416-695-3966 evenings.

386SX33-4MB RAM-85HD VGA Monitor-Keyboard Mouse-Epson 24 Pin P. loaded with software. Call 650-2200 ex. 82020.

486DX2/50, 4MB, 2FDD, 120HD, SVGA card & monitor, modem & SndBlgtr. Vadim 604-3194, 339-5056Y pager).

486SX 20MHZ 2MBRAM 120MHD 1.44&1.2MB FD Fax/mod SVGA 14" mon mouse 5..warr \$990 0b0. Tel. 763-3019.

1084's stereo monitor RGB/composite switchable works like new. \$250. 977-0922.

1200DPI x HP4 full postscript language new in box. \$750 obo. Call 225-0839.

1989 Zenith EZ PC IBM Compatible. 20 MB HD, monochrome monitor. Games & Microsoft works included, great for word processing. Asking \$400 obo. Call 416-422-5131.

ACER 386/20 Laptop for sale. 8meg RAM, 60 meg HD, 4800/9600 FAX MODEM, 3.5" floppy, super back twist screen, carrying case. B.O. tel. 905-830-9397; Fax when on line 905-830-9144; Pager #96567 @ 800-268-0600. Dave Schragge.

AMAZING 1024\*768\*28dp. Non-interlaced. \$275. 495-9649.

AMIGA 500 1M RAM 108 4S Monitor, 2 joysticks, games, warranty cards, like

new. Original boxes. Asking \$400. (incl. mouse and external floppy dr.) Greg 905-832-0649.

AMIGA 500 1MB, 1084 stereo monitor, software \$400. Mississauga 712-1452.

AMIGA 500, 1 meg + 2nd floppy + modem + sampler + better mouse and 100s of disks \$250. Excellent condition.

AMIGA 2000 53 Meg GVP3 mg fast 1 mg chip 2x3.5 DD 1084s mon. \$1200. 493-6048.

AMIGA 3000 6 megs ram 1438 SVGA mon. 53 meg HD and 210ext. HD in mint condition. \$1600. 745-1739.

AMIGA 3000: 6meg RAM 52meg HD, 210 meg ext. HD, 3.1 OS, SVGA, monitor, in mint condition. \$1600. Call Bruno 745-1739.

AMPX dumb terminal \$150 (bo), accounting software \$99 & \$150 firm. Call Steve 905 454-8580.

APPLE StyleWriter printer complete with installation software and manual. \$215 obo. Call Tim 487-6373.

ARTISOFT Ethernet adapter cards sell-

ing \$130. Faxline manager selling \$80. Call 490-6785.

ATI VIP Card, 800x560 .256 colors. Also steel PC Desktop case with 200 watts power supply. Call Mike at 298-9007. After 6 pm. Great prices. 298-9007.

ATARI 1040ST, upgraded, color monitor, two 3.5" driver, printer, modem, WP, terminal, graphics, spreadsheet, database, games, 100+ disks. \$495 obo. Allan 482-1680.

C-64 Complete system + software. As new. \$150 firm. Call 905-459-8390.

C64SYS 2 driv 2prin mon 100's prog 3Joy. All cables, books, mod. \$160 or trade for laptop + cash. Chris 763-1328.

CARLISLE DC2000XL mini data cartridges same as 2120's - four available \$13. eck. Call Frank 905-851-7903.

CD ROM: For Sale. Sony 31A \$300. 441-1898.

COM64C includes CRT, mouse, keyboard and more asking for \$400 obo. Call between 4 pm and 10 pm. Ben 609-1967.

DELL UltraSan 17" color monitor. Asking \$1200. George 222-1382.

DELL Ultrascan 17" color monitor. Asking \$1200. George 222-1382.

EGA & CGA Card \$25. Modem \$30. 829-4444.

EGA Color monitor with 8 bit card. \$60. 763-9013.

EPSON 286/12, 2MB RAM, 1.2/1.4 FDD, 40 MB HD, copro, VGA card, mono monitor, software. \$400. 483-5976.

EPSON GQ3500 Laser HP emulation. \$450. Computer desk \$35. 483-5976.

EPSON XT 20mbHD 2x360 KFD, mono. \$300 obo. Epsoon 9 pin printer LX 800. \$120 obo. Exc. cond. Call Rafal 905-453-2581.

EXCELLENT 4-way 300-watt speakers w/ 12" woofer. Brand new w/ warranty. Wish to trade/sell. Please leave inquiry @ 416-730-9237. 24 hrs.

FOR SALE - color printer Star \$300. Fax/modem A6/24 \$50. Tel: 222-2302.

HARD Drive - 170 Mb-ACAD12 - New. 416-324-8372.

## CALENDAR OF EVENTS

### FEBRUARY

POWERING UP NORTH AMERICA - REALIZING THE INFORMATION INFRASTRUCTURE. Presented by Canadian Advanced Technology Ass'n/Information Technology Ass'n of Canada. FEB 1&2nd. Metro Toronto Convention Centre. For further information, please contact Alysonne Will(ext 225) or Julia Williamson(ext2340. 862-9067.

COMPUTER FEST-TORONTO. FEB 18-20. Automotive Building, Exhibition Place. Canada's largest computer show and sale. Seminars, demonstrations and free advice. Hrs: Fri. 10am-9pm. Sat&Sun 10am-6pm. Call 925-4533.

### MARCH

CLIENT/SERVER WORLD CONFERENCE & EXPOSITION. Mar.8-10th.Metro Toronto Convention Centre.For information call (508) 470-3880.

SOFTWARE WORLD. MARCH 8-10, 94. Toronto. Contact: Digital Consulting Inc., 508-470-3880

COMPUTER FEST - MONTREAL. Mar. 18-20. Place Bonaventure. Call 514-844-0502.

3RD ANNUAL HOME OFFICE SHOW. Mar 23 &24, 1994. Metro Toronto Convention Centre. The largest event for people who operate home-based businesses. Over 400 exhibits. For more information please call Jacqueline Peake, Corporate Events Management. 416-869-0141.

S.I.A.Q. '94. THE QUEBEC CITY BUSINESS COMPUTER SHOW. Mar 23-25. Quebec City Convention Centre. For information call Industrial Trade & Consumers Shows Inc. Steve Prahalis 514-270-5481.

### APRIL

COMPUTER FEST-MISSISSAUGA. Apr.8-10. International Centre,Bldg 6. Canada's largest computer show and sale. Seminars, demonstrations and free advice. Hrs: Fri. 10am-9pm.Sat&Sun. 10-am-6pm.Call 925-4533.

THE PERSONAL COMPUTER SHOW. April 29,30 and May 1. Montreal's Palais des Congres. PC EXPO will deliver over 15,000 buyers in three days. For more information call Industrial Trade & Consumer Shows Inc. 514-270-5481.

### MAY

CANADA'S ADVANCED ELECTRONICS SYSTEMS EXPO. May 3rd&4th. Ottawa Congress Centre. For more information call Reed Exhibition Companies 416-491-7555.

MULTIMEDIA '94'. May 27-28, 1994. Toronto Convention Centre. An exposition and Forum featuring Multimedia Communications, Vicom, Electronic Design, Pro-

### INTERNATIONAL:

ASIACOMM February 12-14, 1994. Bangkok. Contact: Reed Exposition Companies 203-964-0000.

HOME MEDIA EXPO/ DIGITAL VIDEO L.A. Feb. 7-9,94. L.A., CA. Contact American Expositions Inc., 212-226-4983

HP WORKSTATION EXPO. FEB. 8-9, 94. San Jose, CA. Contact: PCI Trade Show Management, 800-727-EXPO

DOCUMET & IMAGE & WORKFLOW CONF. Feb. 13-15, 94. San Diego, CA. Contact: BSI Strategic Decisions, 617-982-9500

MACWORLD EXPO. Tokyo. Feb 17-19, 1994. Nippon Convention Center, Tokyo, Japan. Contact: Susan Leary at IDG World Expo at 800-225-4698 or 508-879-6700.

GROUPWARE BOSTON '94. Feb. 27- Mar 2, 94. Contact : The Conference Group, 602-661-1260

WINDOWS & OS/2 - West. Mar 14-18, 94. San Jose, CA. Contact: Miller Freeman, 415-905-2200

COMDEX/ COMEXPO. Mar 8-11, 94. Mexico City, Mexico. Contact: Interface Group, 617-444-0165

CEBIT. Hannover. Mar 16-23, 94. Hannover, Germany. Contact: Hannover Fairs, USA, 609-987-1202

MULTIMEDIA WORLD '94'. March 21-24, 94. Las Vegas, Nevada. Contact: Interface Group, 617-449-6600.

UNIFORM '94. Mar 21-25, 1994. An extensive conference focusing on Open Systems, also offered; over 70 conference sessions, 10 tutorials, 4 hands-on workshops, 3 plenary sessions and two executive symposiums. Moscone Convention Center, San Francisco, CA. Contact: Tonia Ware at IDG World Expo at 800-225-4698 or 508-879-6700.

COMPUTERWORLD EXPO. Auckland, NZ. Mar.23-25, 1994. Contact: Matt Mandino at IDG WorldExpo at 800-225-4698 or 508-879-6700.

PAGEMAKER CONFERENCE. March 28-29, 94. Boston, Mass.. Contact: Thunder Lizard Productions, 206-633-3431

LAP & PALMTOP. March 29-30, 94. New York, NY. Contact: Laptop Expositons, 212-682-7968

QUICKTIME: The Conference & Film Festival. Mar 30- Jan 31, 94. San Francisco, CA. Contact: Sumeria, Inc., 415-904-0813.

NEW MEDIA EXPO: APRIL 12-14, 1994. Los Angeles Convention Centre, Los Angeles, CA. A sales and marketing event for multimedia manufacturers and suppliers focusing on existing market opportunities and new media technologies. Call 617-449-6600, ext.4023.

WINDOWS tm WORLD/MILAN: April 13-16, 1994. Spazio Milano Nord, Milan Italy. A premier event for vendors and buyers of Windows hardware and software products. Special pavilions and conferences highlight the latest in market trends. Contact: Chris Blanchard at IDG World Expo at 800-545-3976, or 508-820-8629.

APPLE '94: April 21-23, 1994. Castle of Vajdahunyad City Park, Budapest, Hungary. Part of the MACWORLD Expo series, the most successful Trade show series for Apple-related products and services. Contact: Susan Leary at IDG World Expo at 800-545-3976 or 508-879-6700

PC WORLD EXPO: April 25-27, 1994. Stockholm, Sweden. Contact: Chris Blanchard at IDG World Expo at 800-545-3976, or 508-820-8629

COMNET PRAGUE: May 25-27, 1994. Prague, Czech Republic. The first data, voice, and communications exposition and conference of its kind in Central and Eastern Europe since the creation of the new Republic. Contact: Lisa Judd Parkins at IDG Worls Expo at 1-800-820-8629 or 1-800-879-6700

SEMINARS

MOBILE COMPUTING/FIELD FORCE AUTOMATION-Feb 17, '94. Will show you how notebook computers, pen-based computing, etc..can make you and your organization more effective and productive.

ELECTRONIC DOCUMENT MANAGEMENT-March 17, '94. Learn how to get the best value from the use of electronic document management technologies.

RAPID APPLICATION DEVELOPMENT-April 21, '94. Will show you how to develop information systems with a high level of user involvement and support.

ELECTRONIC PUBLISHING-May 19, '94. Learn how electronic publishing and on-line documentation can reduce costs and enhance retrieval of information.

For more info. or to register for the seminars, call Flynn McNeil Reheb and Associates at (416) 925-8111 or Fax: (416) 925-8515.

SEMINARS

FREE LUNCH TIME SEMINARS. Clascom Computers. Jan 24(Mon), Jan 26(Wed). 12-12:45 Windows NT: Fundamentals by Peter Ip. 1-1:45 ReEngineering: The Real Story by David Eisen. Jan 28(Fri) 12-12:45 LAN Fundamentals by Max Haroon. 1-1:45 ReEngineering: The Real Story by David Eisen.Call Teodor Gug 416-369-9944.

THREE COMPREHENSIVE COURSES from CMC. Fundamentals of Marketing: Concepts and Practices. Feb 28-Mar 3. May 9-12. Product Management. Mar 21-24. Call Canadian Management Centre 416-593-4600.

High Point Mall  
3415 Dixie Rd. (at Bloor)

## pc SERVICE BUREAU

MISSISSAUGA'S FIRST computer service bureau

- \*Personalized Training
- \*Instructors
- \*Graphics
- \*Printing
- \*Resume
- \*Advice
- \*Repairs
- \*Software
- \*Computers
- \*Rubber Stamps

238-2636

VALUE COUPON

No Purchase Necessary On Selected Services.

- 2 local taxes  
- 2 laser print job  
- 2 hour computer rental

10% - 20% off Hardware & Software DISCOUNT

**FREE**

REPAIR ESTIMATES or COMPUTER CLEANING A \$40 VALUE

VALUE COUPON

|   |          |
|---|----------|
| 1/4Mb SIMM RAM 70/60ns                                  | \$CALL   |
| Sound Blaster 16  | \$179.00 |
| Sound Blaster 16 Multi-CD FREE Encicl.                  | \$239.00 |
| Sound Blaster 16 SCSI FREE Encicl.                      | \$269.00 |
| Sound Blaster 16 ASP FREE Encicl.                       | \$295.00 |
| Diamond Sound Sonic DSP                                 | \$299.00 |
| Seventh Guest CD FREE                                   |          |
| Diamond Viper 2Mb VESA VGA card                         | \$549.00 |
| Diamond Stealth 1Mb VESA VGA card                       | \$349.00 |
| Diamond Speed Star 1Mb VESA VGA                         | \$179.00 |
| Quantum S3 805 VESA VGA Card                            | \$159.00 |
| Panasonic 562 CD-ROM Drive                              | \$289.00 |
| Philips 206 CD-ROM Drive                                | \$289.00 |
| DOS 6.2 & Windows 3.1 with system                       | \$100.00 |
| Sound Blaster, Speakers, Microphone, CD-Title, Joystick | \$99     |

2 Years Parts & 3 Years Labour Warranty  
Prices may be lower than advertised and may change without notice - CALL!

**Smart Machine**

Tel. (416) 920-3252 Fax. (416) 921-8940 Open Mon-Sat 10-7  
1255 Yonge St. suite 102 Toronto Ontario M4T 1W6

HIGH QUALITY VESA PRO LOCAL BUS

486DX-33/40 256K Cache

INTEL i486DX33CPU or AMD 486DX40(YOUR CHOICE)

3 VL-BUS Slots

8Mb RAM 70/60ns

340Mb Seagate 256K Cache 12ms HD

1Mb 32bit VL-BUS SVGA S3 805 Accelerator Card

VL-BUS 32bit IDE & I/O Controller 2s/1p/1g

Non-Interlaced 0.28 KDS SVGA Monitor

Miniflower case 5 bays 230W PS

Genuine Microsoft II mouse & Pad

101K Keytronics 2000 Enhanced KB

15" Samsung SVGA 90Hz N.T. 1024X768

Flat Screen, Low Radiation, Digital Ctrl. CPU +\$250

**2,049**

**9247**



# COMPUTER DIRECTORY

## LASER CHEQUES

For *Quicken* & other Accounting software.  
Standard business cheques also available.  
40% less than the bank. Shipped within 48 hours!  
**Guaranteed lowest price!** Company logo included!  
Security features on all our products!  
**Quick Cheques Inc.**  
463 Centre St. E. Unit 2 Richmond Hill Ont. L4C 1B8  
Tel: 905-508-6129 Fax: 905-508-0114



## SOFTCARE

COMPUTER SERVICES

- CLEANING • REPAIRS
- PREVENTATIVE MAINTENANCE

PERSONAL COMPUTERS AND MACINTOSH

**WE CLEAN ON SITE**  
COMPUTER SYSTEMS • TERMINALS • PRINTERS  
• COMPETITIVE RATES ON ALL REPAIRS

**OTHER SERVICES INCLUDE**  
DIAGNOSTIC ANALYSIS OF DISK/HARD DRIVES

**RATES FROM \$35 • BUSINESS • SCHOOLS • HOMES**  
**(905) 775-9251 • Toll Free 1-800-363-0526**

# OKIDATA®

Sales & Service Centre  
IN-WARRANTY & POST-WARRANTY  
REPAIRS TO LED & DOT MATRIX  
Microset Systems Inc.  
PH (416) 283-4949 Fax (416) 283-5650  
1335 Morningside Ave., Unit 7, Scarborough, ON, M1B 5M4

## Don't Know Accounting?

No accounting experience necessary to use our computerized accounting systems for small business. Handles A/R, A/P, Inventory, Balance Sheet, Statements. Canadian Software featured. Our low prices include software, installation, setup, training & support by an accountant.

**CALL LEE BABCOCK 267-6921**

## Computer Freelancers UNLIMITED INC.

**One Call Does it All!**  
Just one call connects you with talented, independent computer experts, available to work for you on their computer or yours by the hour, the day, or the project.

**In Toronto Call: (416) 222-6221**  
**Outside Toronto: 1-800-268-2710**

5075 Yonge Street, Suite 403, North York, ON M2N 6C6

CONSULTING ■ TRAINING  
**Windows & DOS**  
COMPUTERS ■ SOFTWARE

Systems Integration  
Network Installations  
Training

**M.A. LAMOTHE & ASSOCIATES INC.**  
10 Oak Ridge Drive, Georgetown, ON L7G 5G6  
Georgetown Phone: (905)877-2203  
Toronto Phone: (416)798-7889  
Fax: (905)877-4811



## DeskJet/BubbleJet Refills 5/\$49. Safe

for your printer. D/J 51608A, JP150 B/J 10E, 20, 200, Stylewriter, Star, Fax. New D/J51608A & 3 Refills \$59. OR change above black to colour 2/\$39. D/J 51626A 4/\$79 \* 500C col. 12/\$139. PaintJetXL OR BJ800 -bcmy 2/\$39.  
62 Mimico 1 light E. Royal York Rd. N. Lakeshore  
**Image Control 251-4950 visa mc**

## DATA RECOVERY

Hard Disk and Data Recovery Specialists

- Non bootable or inaccessible drives
- Corrupted files & directories
- DOS, Novell, Unix & Mac expertise
- Highest success rate
- Canada-wide service
- No Charge for evaluation
- Phone for Free Information packet

**(416) 510-6990 1-800-563-1167**  
Data Recovery Services Inc. - Toronto

We are looking for low cost software for DOS or Windows. Have your own programs ready and call us.

## Students' / Freelancers' Software Wanted

Educational / Entertainment / Niche Utilities  
Home Business / Office Productivity / ...

**Ponlix Multimedia**  
A CD-ROM & Software Publisher  
**(416) 609-2083**

FAST ON-SITE SERVICE FOR PCs, PRINTERS, AND PERIPHERALS.

# Orbit

Computer Services  
24 Hour Service Available  
Phone (416) 730-9761  
Fax (416) 730-0194

## PRESENTATION EDGE INC.

Suite 200, 138 Huron Street  
Toronto Ontario M5T 2B2  
599 3869 Fax: 340 9309

### PC/WINDOWS OUTPUT

- 2400 dpi lino output
- 1200 dpi laser output
- 24-bit Colour Printing on a Fiery Rip
- Fuji Colour PrePress Proofs
- Crosfield 4000 dpi Scanner
- Free WinTips our DTP/Windows Newsletter!

Send us your MAC & PC files for quick convenient service!

3T **2000's Technology (3T) Inc.**  
Computer Products Sales & Services

## Computers & Parts

(Dealer Price)  
**Upgrades/Rentals**  
Networking/On Site Services

**Tel: (416) 502-2055**  
250 Consumers Rd., #100 Willowdale

RENT • RENT • RENT • RENT • RENT • RENT

## IBM COMPATIBLES, LAPTOPS & PRINTERS

RENTALS • WEEKLY • MONTHLY • YEARLY  
FREE DELIVERY AVAILABLE  
SPECIAL RENTAL PLAN FOR SMALL BUSINESS OR HOME OFFICE  
STUDENT DISCOUNTS ON RENTALS  
ALSO SALES • SERVICE • LEASING • TRAINING  
• PRINTERS • MONITORS • MODEMS • RIBBONS • NETWORKING  
• ALL COMPUTER ACCESSORIES

MONDAY TO FRIDAY  
11:00 AM - 6:00 PM  
**(905) 829-2155**

**Wonimation**  
OAKVILLE, ONTARIO

## The Connection BBS

Experience the Adventure!

32 Chat Lines

Shareware/Gifs  
Downloading/Uploading  
Networking Around the World

News and Information  
Canada's Largest Adult BBS  
Gay/Lesbian/Bi/Straight

Meeting People • **(905) 882-8161** • Making Friends  
Outside Toronto **(416) 229-9732**

"MODEM THE EASY WAY"

## COMPUTERLINK

BBS: 233-5410 VOICE: 233-7150

### WINDOWS-LIKE BBS

Supports ASCII-ANSI-RIP

INTERNET 60,000 FILES CHAT/GAMES

## WE BUY & SELL USED COMPUTERS

Buy + Sell • Trade In • Trade Up  
Used Computers from \$199 - IBM Compatible

### Dominion Business Machines

100 Adelaide Street East  
**364-2978 Since 1902 364-0191**

## ROBERT LIANG

B.A.Sc., M.Eng., P.Eng., LL.B.

### BARRISTER & SOLICITOR

Computer Law, Business Law, Trademarks

330 Hwy 7 East, Suite 309 Phone: (416) 882-0034  
Richmond Hill, Ont., L4B 3P8 Fax: (416) 882-8362

## NEED SPECIALIZED SOFTWARE?

Quickly and economically locate your best options.

**1-800-667-6503**  
**(604) 681-0516**  
Synergy Computer Consulting Ltd.

**SoftSearch®**  
Software Information Service

# Index of Advertisers

## Accounting

Laurel Enterprises ..... 88

## Books

Computer Book Clearance ..... 67  
 Computer & Book Centre ..... 67  
 CPIC - Technical Bookstore ..... 67  
 MC<sup>3</sup> ..... 67  
 Micro Computer Hardware Directory ..... 67  
 Mississauga Computer Books ..... 67  
 Toronto Computer Books ..... 65  
 World's Biggest Bookstore ..... 66

## Desktop Publishing

Fantom Arts ..... 88

## Employment

Jobs Ontario ..... 75

## Events

ComputerFest ..... 90  
 Home Office Show ..... 79  
 Software World ..... 83

## Hardware & Software

1 Stop Computer Shop ..... 8  
 123 Computer Warehouse ..... 89  
 2000's Technologies ..... 88, 89  
 3A Computers ..... 50  
 ABC Computers ..... 47  
 AC Systems ..... 56  
 ACC Technology ..... 49  
 Access Business Centre ..... 17  
 Aceex ..... 71  
 ACM Computer System Ltd. .... 34  
 Alpha Plus Computers ..... 46  
 Ambra ..... 4  
 Amiville ..... 58  
 Annet 2000 Inc. .... 38  
 AmPAQ ..... 9

Anubis Computing Canada ..... 6  
 Apix ..... 64  
 B.U.S. .... 76  
 Baran-Harper Group Inc. .... 62  
 Betacorp ..... 24  
 BICMOS Trading Int. .... 46  
 Business Data Systems ..... 64  
 CAD Connection ..... 24  
 Canadian Business Automation ..... 42  
 Canara Technologies ..... 11  
 Caranet ..... 26  
 C.E.I.D. Corp. .... 56  
 Citizen ..... 3  
 COM Business Service Centre ..... 78  
 Commodore ..... 91  
 Compac RBM Systems ..... 38  
 Compass Technologies ..... 40  
 Compatible Plus ..... 26, 67  
 Complete Micro Solutions ..... 2  
 Compu City ..... 20  
 Compu-Tel ..... 30  
 Compumemories ..... 52  
 Compusoft Business Systems ..... 10  
 Computer Basemen ..... 59  
 Computer Liquidation Centre ..... 42  
 CompuTrend ..... 92  
 Connell Computer ..... 28  
 CPU Data Systems ..... 24  
 CTC Computer Telenet ..... 46  
 CTS Computer Company ..... 28  
 Dominion Business Machines ..... 88  
 Echon Computer ..... 76  
 Eurocom ..... 16  
 Express Micro ..... 14  
 Faxcessories ..... 49  
 G.C. Systems ..... 53  
 GHE Inc. .... 37  
 GigaTrend ..... 26  
 Global Drive Solutions ..... 10  
 Hi-Tech Services ..... 62

HITS ..... 22  
 HVM Computer ..... 38  
 IBM Canada Ltd. .... 21  
 Kadcom ..... 78  
 Kehtron Computer Inc. .... 42  
 KV Computers ..... 56  
 Lance Electronics ..... 31  
 Logic Computer House ..... 19  
 MDG ..... 41  
 Media CD Shop ..... 20  
 MegaChoice ..... 55  
 Micro Drives Canada ..... 73  
 Microview ..... 37  
 MIT Computer Supplies ..... 61  
 Multimedia Effects ..... 68, 80  
 Musicware Distributors ..... 30  
 NAK Technologies ..... 25  
 Oak Street Software ..... 89  
 Ocean Electronics ..... 36  
 Onward Computer ..... 49  
 OTA Computer Centre ..... 37  
 Ottawa Valley ..... 8  
 Overall ..... 70  
 Patch Computers Ltd ..... 74  
 PC Factory ..... 13  
 Plustek Canada ..... 63  
 PoCo ..... 78  
 Ponlix Multimedia ..... 12, 88  
 Provincial Products Inc. .... 57  
 Rainbow Computer ..... 40  
 Rocket Computer Systems ..... 23  
 Sayson Technologies ..... 72  
 SBL System Builders Limited ..... 43  
 Scansource ..... 89  
 Service Works ..... 78  
 Signa Computer ..... 15  
 Sirus Tech ..... 51  
 Smart Luck Software ..... 60  
 Smart Machine ..... 86  
 Softec Business Computer ..... 48

Software Galore ..... 40  
 Software Solutions ..... 81  
 Sunni Microlab ..... 6  
 The Notebook Store ..... 36  
 The Soft Connection ..... 38  
 Throne Computer Systems ..... 54  
 Time Computer Products ..... 18  
 TTI ..... 44  
 Ultinet-Computer ..... 7  
 Vina Computer ..... 12  
 VIVE Synergies ..... 57  
 World Business Systems ..... 27  
 Zegna ..... 39  
 ZipCode Software ..... 53  
 Zyxel ..... 81

## Online

ComputerLink ..... 88  
 CRS ..... 69  
 Cybercity Communication Inc. .... 46  
 HookUP Communication ..... 8  
 Internex Online ..... 62  
 Power Windows ..... 68  
 Programmers Guild ..... 89  
 Publishers Resource Centre ..... 70  
 The Connection BBS ..... 88

## Payroll

Paymate ..... 64

## Rental

ABS Group ..... 64  
 Wonimation ..... 88

## Service Bureau

PC Service Bureau ..... 86

## Service & Consulting

About Computers... 89  
 Computer Freelancers Unlimited ..... 88

Data Recovery Inc. .... 88  
 Dinamis Corporation ..... 51  
 Image Control ..... 88  
 M.A. Lamothe & Associates ..... 88  
 Microset ..... 88  
 Orbit Computer Services ..... 88  
 On-Site Services ..... 89  
 Presentation Edge ..... 88  
 Quickcheque Inc. .... 88  
 Robert Liang ..... 88  
 Softcare Computer Services ..... 88  
 Synergy Computer Consulting LTD .. 88

## Shareware

Alternative Personal Software ..... 89  
 Marcom Computers Canada ..... 29  
 Shareware Connection ..... 89

## Subscriptions

Subscriptions ..... 85

## Tax Software

Alitz ..... 64  
 Datatax ..... 34  
 Cantax Corporation ..... 32  
 HomeTax ..... 33  
 Wintax Software ..... 35

## Training

Adept ..... 84  
 CMS Training ..... 82  
 International Academy ..... 84  
 Microbus ..... 82  
 NRI Schools ..... 45  
 SAIT ..... 82  
 SoftTrain Institute ..... 82  
 Starlight Inc. .... 84  
 Training Now - For Tomorrow ..... 82  
 User Friendly Organization ..... 88  
 Xemix ..... 82

This index is provided as a reader service. Every effort has been made to make it as complete as possible, however, the publication does not assume liability for errors or omissions.

## Quality Software at an Affordable Price

Shareware software is fully functional Try-Before-You-Buy Software that comes with on-disk documentation or on-line help.

We have a selection of almost 3,000 of the highest quality Shareware programs available for DOS and Windows. Categories include: Accounting, Finance, Database Management, Forms Creation, Labels, Mailists, Spreadsheets, Education, Astrology, Games, Genealogy, Health, Nutrition, Lottery Analysis, Religion, Sports, Graphics, Desktop Publishing, Clip Art, Fonts, Word Processing, Astronomy, Engineering, Math, Science, Utilities, Programming, and more.

We charge a fee per disk (as low as \$2.25 with quantity discounts) so that you can inexpensively try software to see if it meets your needs. If you wish to continue to use the software, you should send the author the registration fee (typically \$5 to \$35).

For a free 100-page catalogue call:  
**Alternative Personal Software**  
 (800) 667-3475

Toronto area call: (905) 796-0892  
 or write: 8 Rosehampton Cr., Brampton,  
 Ontario L6Y 2R4 Fax: (905) 453-9606

## We speak bar code.

- wands•laser scanners
- portable readers•label printers•label printing software•magnetic stripe readers•

Free delivery anywhere in Canada. Quality products. Low prices. Resellers welcome.

**ScanSource**  
 Canada Ltd. 1-800-665-SCAN (7226)  
 FAX 1-800-363-SCAN (7226)

## ON-SITE SERVICES

ON-SITE PC, MAC, MONITORS & PRINTER (LASER) REPAIRS. UPGRADES TO VIRTUALLY ALL BRANDS. NEW & USED PARTS. NETWORK & SOFTWARE SUPPORT. SERVICE AGREEMENTS. FONTS: PUNJABI, BANGALI, HINDI & GUGARTI

**PCs Xpert Corporation** Rates From \$35  
 100 Westmore Dr. Unit 11C (416) 520-7102  
 Etobicoke, Ont., M9V 5C3

## IBM SHAREWARE

High Quality Programs, Latest versions, AS LOW AS 99¢ per disk  
 Home/Business, Games, Education, Databases, Utilities, Graphics, Music, Engineering, & Windows Appl.  
 Please call, write or fax for a free Menu-driven Catalog (specify 3 1/2" or 5 1/4" disk)  
 To: **SHAREWARE CONNECTION**, P.O. Box 68028  
 Calgary, AB, T3G 3N8 Voice/Fax: (403) 241-2672

## Oak Street Software

Promoting Software Development in Canada

- Full Range Of Services For Software Developers
- Comprehensive Testing & Marketing Service
- Centralized Order Processing/ Customer Service
- Documentation & Diskette Production

**519-824-0323**

P.O. Box 25074, Guelph, Ontario, N1G 4T4

TELL ADVERTISERS  
 YOU SAW THEIR  
 AD IN



# 123 COMPUTER WAREHOUSE INC. Since 1984

|   |  |   |
|---|--|---|
| <p><b>386-DX40MHz</b><br/>                 •VESA Local Bus • 128k cache<br/>                 • 4 Mb Ram<br/>                 • 128 Mb Hard Drive<br/>                 • 1.44 Mb floppy drive<br/>                 • SVGA 512k video card<br/>                 • Minitower case<br/>                 • 101 Enhanced keyboard<br/>                 • Monitor extra<br/> <b>\$799</b></p> <p><b>486-SX25MHz</b><br/>                 •VESA Local Bus • 128k cache<br/>                 • 4 Mb Ram<br/>                 • 210 Mb Hard Drive<br/>                 • 1.44 Mb floppy drive<br/>                 • SVGA 512k video card<br/>                 • Minitower case<br/>                 • 101 Enhanced keyboard<br/>                 • Monitor extra<br/> <b>\$925</b></p> <p><b>486-DX33MHz</b><br/>                 •VESA Local Bus • 128k cache<br/>                 • 4 Mb Ram<br/>                 • 245 Mb Hard Drive<br/>                 • 1.44 Mb floppy drive<br/>                 • SVGA 1M video card<br/>                 • Minitower case<br/>                 • 101 Enhanced keyboard<br/>                 • Monitor extra<br/> <b>\$1195</b></p> | <p><b>MONITORS</b></p> <p>Darius 14".41 VGA \$249<br/>                 Datatrain 14".28 SVGA \$290<br/>                 Daewoo 14".28 SVGA \$305<br/>                 Hyundai 14".28 SVGA NI \$335</p> <p><b>PRINTERS</b></p> <p>EPSON<br/>                 LX 810P \$ 213<br/>                 FX 870 \$ 369<br/>                 FX 1170 \$ 515<br/>                 LQ 570+ \$ 320<br/>                 LQ 860 \$ 725<br/>                 LQ 870 \$ 580<br/>                 LQ 1070+ \$ 470<br/>                 LQ 1170 \$ 750<br/>                 Action Laser 1000 512k \$ 845<br/>                 Action Laser 1000 2Mb \$ 920<br/>                 Action Laser 1500 1Mb \$ 925<br/>                 EPL 8000 \$1200</p> | <p><b>DISCOVERY 16</b><br/> <b>Multi Media Kit</b><br/>                 • Double Speed CD ROM<br/>                 • Sound Blaster 16 bit<br/>                 • Pair of Speakers<br/>                 • 5 CD Titles<br/> <b>\$595</b></p> <p>LQ 2550 \$1145<br/>                 DFX 5000 \$1775<br/>                 DFX 8000 \$2900<br/>                 Stylus 300 \$ 305<br/>                 Stylus 800 \$ 385</p> <p><b>Raven</b><br/>                 PR-2405 \$ 249<br/>                 PR-2406 \$ 275<br/>                 PR-2420 \$ 369<br/>                 PR-2465 \$ 435<br/>                 PR-2465Q \$ 525<br/>                 LP-510 \$ 710<br/>                 LP-530 \$ 999<br/>                 LP-1130 \$1625</p> |
|---|--|---|

Purchase orders from governments, corporations & institutions are welcome  
**253 Queen St. E., Unit 2, Brampton L6W 2B8**  
**TEL:(416)451-6769 FAX:(416)451-9361**

## High Quality Products Specials

### 3T CAD/Business/Multi-media Systems:

- Intel 486DX-33/DXII-66 CPU, 8K Cache Internal
  - 256K Cache, Pentium Ready Technology
  - 341MB Fast Hard Drive
  - 1.44MB & 1.2MB Floppy Drives
  - 8MB Fast RAM
  - 101/102 Enhanced Keyboard
  - 17", 1280 x1024 Monitor
  - 1MB VESA Local Bus Video Card
- 486DX-33 ..... \$2,999  
 486DX-66 ..... \$3,299

Lease to Own Program is Available  
 Networking, On-Site Services, Computer Upgrades & Computer Rentals (for companies) are available  
 Government and Company Purchase Orders are Welcome. **Open Sundays**

**2000's Technology (3T) Inc.**  
 (416) 502-2055  
 250 Consumers Rd.  
 #100 Willowdale, Ontario

**TORONTO!  
COMPUTES!**

Presents

# COMPUTER FEST 94

Spring

FEBRUARY  
18, 19 & 20

Friday 10 am - 9 pm  
Sat. & Sun. 10 am - 6 pm  
Automotive Building  
Exhibition Place  
(Just inside the Princes' Gates)

**BUSINESS, EDUCATION, HOME**

- 100 Exhibitors • All Types of Micros
- Manufacturers' Pavillion
- Free Advice from Experts
- MIDI Music On Stage

Free Presentations,  
Demos & Advice

Great  
Deals &  
Selection



For more  
information  
call 324-0765

## Canada's Largest Computer Show & Sale

**INDIVIDUAL  
ADMISSION**

only **\$6**

Limit of one coupon per one-day admission

WITH THIS COUPON  
**COMPUTER FEST**

All prices include GST and entertainment tax

**FAMILY  
ADMISSION**

only **\$18**

Maximum 2 adults and children under 17

February 18, 19 & 20

Friday, 10 am to 9 pm: Sat. & Sun. 10 am to 6 pm

Automotive Building, Exhibition Place, Toronto

**We have a very  
important  
announcement  
to make**



Commodore personal computers are 100% DOS compatible! A lot of very happy computer users already know that. In fact, governments and educational institutions across Canada have been specifying Commodore PCs for years.

## Commodore Personal Computers

Unfortunately, a lot of otherwise very knowledgeable computer buyers tend to think of the Amiga or even the Commodore-64 when they hear our name.

That's not surprising. After all, with over 10 million sold, the C-64 is the number one selling personal computer of all time. And there are over 3 million Amigas out there!

But we digress.

If you already know everything about Commodore's DOS-compatible PCs, you probably own one. If not, don't you think it's time you called us?



For more information on the solid value and innovative technology that stand behind every Commodore PC call us today (toll free) at **1-800-463-5203**.

The Intel Inside Logo is a registered trademark of Intel Corporation.



### Commodore 453MPC MULTIMEDIA SYSTEM

- Intel 486SX-33MHz CPU
- VESA local bus
- 4MB RAM
- 8k level-1 cache • 128k Level-2 Cache
- 170MB hard drive
- 1.44MB floppy drive
- Super VGA Monitor, 0.39dp
- VESA SVGA video card
- MS DOS 6.2, Windows 3.1
- Commodore mouse
- 3 Yr. Warranty, 1 Yr. On-site

**PLUS!**

- Double speed CD ROM drive
- Sound Blaster compatible card
- Internal speakers
- CD titles: MS Works, Dinosaur/Space, and 3D Animania

**\$1995.00**

Includes:  
• Microsoft Works  
• Knowledge Adventure Space  
• Knowledge Adventure Dinosaurs  
• 3D Animania  
**\$299.00**  
Retail Value!

## Trend MULTIMEDIA SYSTEM

**INCLUDES:**  
 Sony CD ROM  
 Sound Card  
 Stereo Speakers  
 2 CD Titles  
 MS Bookshelf '93  
 Dinosaur Adventure

**ONLY!**  
**\$1575**



**486DLC CPU**  
**40MHz**  
**4MB RAM**  
**1.44MB FDD**  
**170MB HDD**  
**SVGA Card**  
**SVGA Monitor**  
**101 keyboard**

**FREE**  
 Motorola Cellular Phone  
 With DX2 Trend Systems!  
 "New" 8800M  
\*CompuTrend Activation Required

## STANDARD FEATURES



MS DOS 6.2  
 Windows 3.1  
 MS Works 2.0  
(with manuals)

CSA Approval  
**PLUS**  
**FIVE YEAR WARRANTY**

## Trend 486SLC

33MHz, 2MB RAM,  
 1.44MB FDD, 120MB HDD,  
 101 keyboard, SVGA Card,  
 SVGA 14" Monitor

**ONLY!**  
**\$999**

## Trend 4865X

33MHz, 4MB RAM,  
 1.44MB FDD, 170MB HDD,  
 101 keyboard, SVGA Card,  
 SVGA 14" Monitor

**ONLY!**  
**\$1299**

## TREND SYSTEMS

## Trend 486DX

VESA Local Bus, 33MHz, 4MB  
 RAM, 1.44MB FD, 170MB  
 HD, SVGA Card and  
 Monitor, 101 keyboard

**ONLY!**  
**\$1550**

## Trend 486DX2

VESA Local Bus, 66MHz,  
 4MB RAM, 250MB HD,  
 1.44MB FD, 101 keyboard,  
 SVGA Card and Monitor (.28cp)

**ONLY!**  
**\$1799**

## 600 dpi

**HP-4**  
 2MB, 8ppm  
 250 sheet tray  
 laser printer  
 600 x 600 dpi

**\$1850**

**OL-410e**  
 OKIDATA  
 2MB, 4ppm  
 100 sheet tray  
 600 x 600 dpi

**\$878**

**EPSON**  
 Action 1500  
 1MB, 6ppm  
 150 sheet tray  
 300 x 300 dpi

**\$855**

**OL-400e**  
 OKIDATA  
 4ppm  
 100 sheet tray  
 300 x 300 dpi

**\$645**

## 300 dpi

## PRINTERS

### INK JET

**EPSON**  
 Ink Jet  
 Printer  
 Stylus 300  
 360 x 360 dpi  
**\$295**

**Canon**  
**BJ-200**  
 248 cps  
 360 x 360 dpi  
 auto sheet  
 feeder  
**\$338**



### COLOUR INK JET

**Canon**  
**BJ-600**  
 Colour Ink Jet  
 plain paper  
 laser quality  
 360 x 360 dpi  
**\$738**

## FAX / MODEMS

### FAX/Modem

**Robotics**  
 Sportster  
 14.4k, V.32 bis  
 Fax/Modem

**\$199**  
 Internal

**\$219**  
 External

### FAX/Modem

**GVC**  
 14.4k, V.32 bis  
 Fax/Modem

**\$189**  
 Internal

**\$209**  
 External

### FAX/Modem

**Zoltrix**  
 Internal, V.32 bis  
 Fax/ Modem

**\$169**  
 14.400

**\$48**  
 96/48/24

### 24 Pin

**Panasonic**  
 KXP-2023  
**BRAND NEW**

**\$239**

**EPSON**  
 AP-3250  
**HIGH SPEED**

**\$220**

### Colour 24 Pin

**DL-1150**  
 Wide Carriage  
 110 Columns  
 Colour Kit  
 High Speed

**\$369**

**DL-1250**  
 Wide Carriage  
 135 Columns  
 Colour Kit  
 High Speed

**\$450**

## CD ROM CD ROM CD ROM CD ROM CD ROM CD ROM

**PANASONIC**  
**CR-562**  
 320ms access  
 64kb buffer  
 interface included  
 MPC compliant  
 multi session  
 Photo CD

**\$259**

**DOUBLE SPEED**

**MITSUMI**  
**FX-001-D**  
 280ms access  
 64kb buffer  
 interface included  
 MPC compliant  
 multi session  
 Photo CD

**\$249**

**DOUBLE SPEED**

**TOSHIBA**  
**4101**  
**NEW!!!**  
 MPC compliant  
 multi session  
 Photo CD  
 no interface  
**SCSI**

**\$390**

**DOUBLE SPEED**

**NEC**  
**CDR-500**  
 195ms access  
 450kb/sec transfer  
 MPC compliant  
 multi session  
 Photo CD  
**SCSI**

**\$649**

**TRIPLE SPEED**

## MULTIMEDIA

### SOUND BLASTER



**SB-16** \$169  
 Basic

**SB-16** \$225  
 Multi CD

**SB-16** \$248  
 SCSI-2

**Audio** \$65  
 Plus (8-bit)

**Audio** \$118  
 Plus (16-bit)

### ZOLTRIX

### NOTEBOOK COMPUTER

**Lowest Price!**

**486 NC2**  
 4MB RAM, 120 HDD,  
 1.44 FDD, Internal  
 Fax Modem, DOS &  
 Carrying Bag

**ONLY!**  
**\$1799**



**Bondwell**

### MPC KIT

Sony CD ROM  
 Sound Card  
 Stereo Speakers  
 Microphone



**PLUS**  
 2 CD's  
 Dinosaur  
 Adventure  
 &  
 Space  
 Adventure

**\$299**

Daily 10am - 7pm Sat. 10am - 5pm

**Compu Trend**

Scarborough  
 1350 Kennedy Road

**416-288-0325**

Thornhill  
 330 Steeles Ave. W.

**905-889-0199**

Mississauga  
 1870 Dundas St. E.

**905-279-1988**