

The COMPUTER PAPER™

WESTERN CANADA'S COMPUTER INFORMATION SOURCE

NEWS • FEATURES • REVIEWS • EVENTS

IBM & COMPATIBLES • UNIX • APPLE • COMMODORE • ATARI

Define Name

Expenses:

Ran

Mh

Adm

Total expenses

ating incom
margin

Name

Opera

Print

Total

FREE

SPREADSHEETS

- Lotus 1-2-3 Release 3.1
- Microsoft Excel 3.0
- Quattro Pro 2.0
- Lotus Improv
- PlanPerfect

PLUS NEWSBYTES & CALENDAR

SPECIAL REPORTS

MacWorld EXPO
Pacific Rim SHOW

Friendlyware

Serving B.C. Since '83

3499 Kingsway, Vancouver, BC 437-3113



Learning Can
Be Easy!



All you need to know about:

DOS: Dvorak's PC CRASH COURSE AND SURVIVAL GUIDE (\$24.95).

WINDOWS: Kay Nelson's THE LITTLE WINDOWS BOOK (\$16.95).

Introductions to:

Sybox's ABC'S OF (Ventura; WordPerfect; MS Word; Corel Draw; AutoCAD ...)

PROGRAMMERS! Develop Windows Applications with:

Microsoft Press' PROGRAMMING WINDOWS, PROGRAMMER'S REFERENCE, GUIDE TO PROGRAMMING, or PROGRAMMING TOOLS.

HELP? 1,200 BOOKS. WE SPECIALISE IN BOOKS
TO HELP YOU MASTER YOUR POWER SOFTWARE.

SOFTWARE & UPGRADES

Productivity

- Autosketch Version 3 (NEW) \$199.95
- Back-It 4 \$149.95
- Central Point Backup \$67.95
- Corefast Backup \$159.95
- Corel Draw 2.0 \$544.95
- Fastback Plus Combo 2.1 \$169.95
- Glyph Laser Fonts for WP5 \$99.95
- Megaword Bible Silver \$59.95
- Megaword Bible Gold \$144.95
- Norton Backup \$149.95
- Norton Editor \$79.95
- Publish It! 1.2 (NEW) \$239.95
- Microsoft Windows Applications
 - Adobe Type Manager \$99.95
 - Grammatik for Windows \$89.95
 - hDC Windows Express \$79.95
 - MS Entertainment Pack \$44.95

* Hundreds of Other Titles

Education

- Learning Company Super Solvers
 - Ancient Empires \$49.95
 - Midnight Rescue \$49.95
 - Outnumbered \$49.95
 - Treasure Mountain \$49.95

* 150+ Other Titles

Some Hardware & Upgrades

- Adlib Game Card \$149.95
- Advanced Gravis Joystick \$49.95
- Epyx 500 XJ Joystick \$37.95
- Game Port \$29.95
- WICO Ergostick \$49.95
- Kraft Trackball \$97.95
- Logitech Trackman \$139.95
- PC TRAK Trackball \$149.95
- Sound Blaster Music Card \$229.95
- Tadiran Lithium AT Battery \$29.95

COME IN AND SEE THE LATEST COMTEX COMPUTERS OR HEAR THE GREAT SOUNDS FROM THE ROLAND, ADLIB AND SOUNDBLASTER SYSTEMS! ALSO SEE THE NOTEBOOK COMPUTERS FROM SANYO AND BONDWELL!

SOME OF OUR NEWEST AND BEST GAMES



The Most Incredible Adventure Game in History

King's Quest V—An experience the whole family will enjoy!

- King's Quest V (EGA/VGA) \$59.95/\$69.95
- Action Stations - Naval combat 1922-1945 \$59.95
- Battletech Crescent Hawks Revenge \$57.95
- Casino Master - 5 EGA/VGA casino games \$89.95
- F-15 Strike Eagle II - Fly the plane that hit Iraq \$59.95
- Flight of the Intruder - with free novel! \$59.95
- Jack Nicklaus Unlimited Golf & Course Design \$64.95
- Knights of the Sky - 2 players with modem! \$59.95
- Links: The Challenge of Golf \$64.95
- PGA Tour Golf \$57.95
- Red Baron (Accurate 3D) \$59.95
- Where in the World is Carmen San Diego Deluxe \$79.95
- Wonderland - Windowing fantasy adventure \$59.95

* About 850 more titles for IBM, C64 & Apple II Series!

SHARP

6220 Notebook

A Super-Compact Lightweight 286 Notebook with a Paper-White VGA Display and 20 MB Hard Disk

Backlit Triple Supertwist LCD Display with VGA emulation

True Notebook size (11" x 8.5" x 1.4")

Weights only 4 lbs.

12MHz 80C286 Processor

20 MB Hard Disk Drive

\$3580.00

PC-6220



ALPHA COMPUTER AUTOMATION

555 West Hastings Street, Lower Mall, Harbour Centre
Vancouver, B.C. V6B 4N4 Phone (604) 684-8146 Fax (604) 684-8128

PREPOSTEROUS PRICES

On a HUGE SELECTION

of computer books,

bestsellers, all

sorts of books.

And, of course, the

coffee's always on us!



Book warehouse

BROADWAY
632 W. Broadway
Vancouver

ROBSON
1150 Robson St.
Vancouver

RICHMOND
6340 No. 3 Rd.
Richmond

VICTORIA
1301 Government St.
Victoria

OPEN 10 AM - 10 PM SEVEN DAYS A WEEK
and the coffee's always on us!

WHY BUY AT CARDZ?

- Two Year Labour Warranty
- Repairs in real time
- 8 technicians on staff
- Technical room for walk-in support
- Full satisfaction guarantee
- Premium quality motherboards
- Canada's best pricing - you get our best price first
- The choice of computing professionals

MAIL ORDERS ARE WELCOME



ALL MODELS INCLUDE:

- 19" Tower Case with LED display, 6 Bays**
PLUS: 1.44MB Floppy • Serial, Game & Parallel Ports
 • Speaker • 101 Key Keyboard
 • 200W CSA Power Supply • I/O Card
 • All RAM 80ns or faster

FEATURE SYSTEMS

386SX • 1MB RAM, Tower Case	\$899
386-25 True • 25MHz • 1MB RAM, Tower Case	\$1199
386-33C • Cache • 1MB RAM, Tower Case	\$1499
486-25 • Newest Chip, 1MB RAM, Tower Case, 128 K Cache	\$2499
486-33 ISA Bus, 1 MB RAM	\$3299
486-33 EISA Bus, 1MB RAM, Tower Case	\$4999

BEST BUYZ



NEC SILENTWRITER

Affordable Postscript Printers

- NECLC290 8ppm 2MB (On Display) \$1999!
- NEC LC90 6ppm 2MB Sale \$1999
- NEC 260 Laser 8ppm 1MB No P/S \$1199

THE BEAUTY OF OUR WEAPONS

CARDZ Tower SX 1MB

- Runs all the new 386 Software
- 19" LED Tower with 200W P/S CSA
- 46MB Fujitsu OEM 26ms 2yr. warranty 64K Cache Voice Coil Hard Disk
- VGA 1024 x 768 14" Monitor .28mm
- 16 bit VGA card w/512k
- Tactile Keyboard

\$1699



CARDZ Tower 386-25 1MB

- A True 25 MHz Motherboard**
- 387 CoProcessor Socket
 - 19" LED Tower with 200W P/S CSA
 - 45MB Fujitsu OEM 25ms 2 yr. warranty 64K Cache Voice Coil Hard Disk
 - VGA 1024 x 768 14" Monitor .28 mm
 - 16 bit VGA Card w/512k
 - Tactile Keyboard

\$2049



The CAD 33

- 19" LED Tower with 200W P/S CSA
- Fujitsu OEM 45MB 25ms IDE 2 yr. warranty Voice Coil Hard Disk 64K cache
- 1024 x 768 .28 mm Super VGA Monitor
- Tseng 4000 video card 1MB 1024 x 768 256 colours
- Tactile Keyboard

\$2349



Personal Workstation CARDZ 486 128K Cache

- Intel 486-25 Processor, New Version
- 1MB RAM 80ns Expandable to 16MB
- 19" Tower LED Case with 200W CSA P/S
- 1.44MB Floppy Drive
- Tactile Keyboard

\$2499



Baby Battlechip

- 486-25, 4 MB RAM
- Sony 1304 Non-Interlaced Monitor
- Teeng 4000 1Mb Video Card
- Fujitsu 135MB 20ms IDE Hard Drive

\$4299

Lease for \$199/Month

NEW KIDZ IN TOWN

YOU TRUST US FOR OUR PRICES. NOW LOOK TO OUR PRODUCT LEADERSHIP.

Notebook Laptops

- Ask for pricing on:
- Texas Instruments 286 or SX \$3199/\$4499
 - Sharp Notebooks 310 - \$1399
 - Bondwell 310 Plus - \$1689



POCKET BATTLECHIP

American 486-33 Motherboard

- 128K, ISA
- 4MB RAM
- Maxtor 200 MB 15ms IDE Hard Disk
- SONY 1304 Monitor, non-interlaced
- TSENG 4000 VGA Card 1MB

\$5199

MAXTOR SALE

- 200 MB LXT 15ms IDE Hard Disk **\$999**
- 80MB 7080A 17ms IDE Hard Disk **\$499**

SONY/TSENG SALE

- SONY 1304 non-interlaced 1024 x 768 .25mm **\$899**
- TSENG 4000 1MB VGA **\$189**

DOCUMENT PROCESSOR

Don't Know What It Is?

- It's hardware image compression plus scanner & printer speeder-uppers. Card from \$2999
- You can file or print more than 25 pages per minute!
- Compress and file images at 15:1 typical compression.
- A complete document/image filing and retrieval system.



From **\$2999**

Optical Storage

- Toshiba CDROM \$899
- NEC CDROM (Fastest) \$1199
- REWRITEABLE DRIVES
- Ricoh \$4999
- Sony \$5999
- All are complete kits



Panasonic WORM Drive **\$2999**

CO PRO'S, MICE, ETC.

Cyrix Coprocessors

D-33	\$599
D-25	\$529

Compatible, fewer cycles, 5 year warranty
Intel series chips also available

LogiTech Ergonomic Serial mouse	\$89
Summagraphics 12 x 12	\$499
Seiko Digitizing Pad	\$399
Nan Tan Keyboard (click)	\$9
Focus Keyboard	2001/\$90 3001/\$110 5001/\$149
Northgate OmniKey Keyboard	\$139

VGA MONITORS

Mitsubishi 800 x 600 M/S, NTSC	\$699
TVM 3A 1024 x 768, Analog	\$599
TVM Mono M/sync 256 Grey	\$299
AOC 1024 x 768 28 mm	\$399
NEC 3D 14" 1024 x 768	\$839
NEC 4D 16" 1024 x 768	\$1699
Nano 16" 1280 x 800 Non-Interlaced	\$1499
Morse VGA 1024 x 768	\$479
Sony 1304 14" Multiscan	\$899
Mitsubishi 16" 1280 x 1024	\$1499
Mitsubishi 6935 non Interlaced 20"	\$2499
Seiko 1440 M/S .25mm	\$699
Seiko 1450 M/S .25mm Non Interlaced	\$899
Seiko 2050 20" .31mm Non Interlaced	\$2599

MISCELLANEOUS

Sound Blaster Music Card	\$199
Tower Case 19" 6 bays 200W Power Supply	\$185
1.2MB or 1.44MB Teac floppy drives, cable	\$89
Extra Serial Port	\$19

MOTHERBOARDS

SX-16 OK	\$499
25 MHz OK	\$789
25 MHz, Cache OK	\$899
33 MHz, Cache OK	\$1024
486, 25 MHz OK, 128K Cache	\$2299
486, 33 OK, 129K Cache	\$2999

MODEMS

Cardinal 2400 Modem S/W MNPS	\$109
Cardinal 2400 Hardware MNPS	\$219
NEW! Cardinal 9600B V32 MNPS	\$699
USR 14.4 HST	\$699
MultiTech v.32 142	\$999
TBBS BBS S/W 16 Line	\$929
ATI 9600 V32/42	\$599

VIDEO CARDS

Monochrome Graphics Card parallel port	\$19
16 bit 1024x768 512k	\$129
Paradise OEM VGA 256k Exp. 512k 1024x768	\$139
ATI VGA Wonder 1024x768 512k with mouse	\$249
Tricom 1024x768 256 colors 1 MB memory Incl.	\$189
Expand memory from 256k to 512k	\$29

HARD DRIVES (BARE)

40 Mb 25 ms IDE Hard Drive	\$299
Mitsubishi 42MB (65MB RLL) 28ms Voice coil	\$349
Rodime 100MB 19ms 64k Cache 3.5" IDE	\$598
Rodime 200MB 19ms 64k Cache 3.5" IDE	\$949
Fujitsu 90MB 25ms SCSI 3.5" IDE	\$699
Fujitsu 135MB 25ms SCSI 3.5" IDE	\$849
Fujitsu 150MB 23ms FH ESDI 200k MBTF	\$1099
Fujitsu 180MB 20ms 3.5" IDE 64K	\$899
Fujitsu 330MB 18ms FH ESDI 200k MBTF	\$1599
Maxtor 80 Mb 17 ms IDE	\$499
Maxtor 159MB 14ms ESDI	\$1299
Maxtor 200MB 15ms 3.5" IDE	\$999
Maxtor 339MB 14ms ESDI	\$1899
Maxtor 339MB 14ms SCSI	\$1899
Maxtor 650MB 16ms ESDI	\$2799

HARD DRIVE CONTROLLERS

IDE Host Adapter (controller) 16 bit, HD/FD, Cable	\$29
Future Domain SCSI 16 bit SCSI, Novell Driver	\$189
Kimpelon 1:1 HD/FD RLL WD Chipset	\$99
UltraStar 20MHz ESDI Cache Floppy support	\$249

Member BBB



Tower Case is Standard on All Models



386 / 486 COMPUTERS

1920 West Broadway, Vancouver, B.C. V6J 1Z2 Open: 9:30 - 6:00 Mon. - Sat.

INQUIRIES: 732-8400 TECHNICAL SUPPORT: 732-8402
 FAX: 732-8412 ORDERS OUTSIDE VANCOUVER 1-800-676-3111

All items subject to availability. Shipping extra, \$39 maximum with insurance.
 VISA add 1.9%. Prices are Cash.

MINIMUM WARRANTY:

ONE YEAR PARTS
 TWO YEARS LABOUR

8 TECHNICIANS
 ON STAFF

CARDZ BBS

(604)

- 4 HST 14.4 lines 734-5400
- 2 V.32 9600 lines 734-5800
- 2400/4800 lines 734-5901
- Prices On Computer Parts
- Full Online Store • Text, GIFS
- Electronic Publishing • Philosophy
- Writer's Hotstove • Intellectual Issues
- Full Product Information

Reliable 486 33MHz is here!

ISA & EISA

Being used by BC Hydro, Westcoast Energy, etc.

SALES & TECHNICAL Position Available

Please Send Resumé to:
 Box 23 1112 W. Pender Street,
 Vancouver, B.C. V6E 2S1
No walk-ins please.

BYTEWELL 286 AT

- 80286 8/12MHz O.W.S. - 1MB, max. 4MB on board - 1.2MB floppy drive - 40MB 28ms hard disk - 101-key click keyboard - 12" monochrome monitor

System Price: \$1049

14" VGA Color 1024x768
 28mm Extra \$599

w/14" color VGA: \$1399

BYTEWELL 386SX

- 80386SX 8/16MHz O.W.S. - 1MB, max. 8MB on board - 1.2MB floppy drive - 40 MB 28ms hard disk - 101-key click keyboard - 12" monochrome monitor

System Price: \$1399

14" VGA Color 1024x768
 28mm Extra \$599

w/14" Color VGA: \$1699

BYTEWELL 386DX

- 80386DX 16/25MHz O.W.S. - 1MB, max. 8MB on board - 1.2MB floppy drive - 40MB 28ms hard disk - 101-key click keyboard - 12" monochrome monitor

System Price: \$1899

14" VGA Color 1024x768
 28mm Extra \$599

64K cache extra: \$200
 33MHz w/64K cache: \$455
 14" VGA color: \$300

ONE YEAR PARTS, TWO YEARS LABOUR ON BYTEWELL SYSTEMS

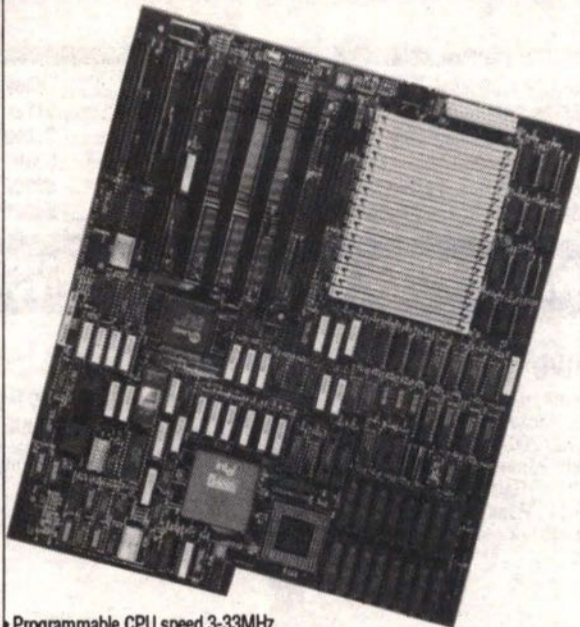

- Programmable CPU speed 3-33MHz
 - 128K external cache / secondary cache using write back algorithm
 - Support up to 32MB
 - Support Weitek 4167 co-processor
- EISA Version all available

FREE WORD PROCESSING, DATA-BASE, SPREADSHEET SOFTWARE WITH MULTITERM COMPUTERS.



All prices include 7% GST

MULTITERM MT-286 AT

- 80286, 8/12MHz, O.W.S.
- 1MB RAM, MAX. 8MB on Board
- 1.2 MB Floppy Drive
- 40MB 28 ms Voice Coil Hard Disk
- 101 Click Keyboard
- 14" Monochrome Monitor
- MS-DOS 4.01 & GW-Basic

14" VGA Color 1024x768
 28mm Extra \$550

System Price: \$1399

MULTITERM MT-386SX

- 80386SX, 8/16MHz, O.W.S.
- 1MB RAM, MAX. 8MB on Board
- 1.2 MB Floppy Drive
- 40MB 28 ms Voice Coil Hard Disk
- 101 Click Keyboard
- 14" Monochrome Monitor
- MS-DOS 4.01 & GW-Basic

14" VGA Color 1024x768
 28mm Extra \$550

System Price: \$1799

w/ 14" Colour VGA \$2179

MULTITERM MT-386DX

- 80386, 16/25MHz, O.W.S.
- 1MB RAM, MAX. 8MB on Board
- 1.2 MB Floppy Drive
- 40MB 28 ms Voice Coil Hard Disk
- 101 Click Keyboard
- 14" Monochrome Monitor
- MS-DOS 4.01 & GW-Basic

14" VGA Color 1024x768
 28mm Extra \$550

System Price: \$2299

64K Cache Extra: \$350
 33MHz w/64K Cache: \$945
 14" VGA Colour: \$380

MULTITERM MT-486DX

- 80486DX, 16/25MHz, O.W.S.
- 128K External Cache
- 4MB RAM, Max. 32MB on Board
- 1.2 MB Floppy Drive
- 100MB 28 ms Voice Coil Hard Disk
- 14" Monochrome Monitor
- MS-DOS 4.01 & GW-Basic

14" VGA Color 1024x768
 28mm Extra \$550

System Price: \$4738

33MHz Extra: \$1150

FIVE YEARS LABOUR, TWO YEARS PARTS ON MULTITERM SYSTEMS. ONE YEAR ON MONITOR



UNISYS

3Com



NOVELL DISKLESS 3 USER SYSTEM \$5254



286 Novell



286 12MHz



286 12MHz

SEE OUR NETWORKING AD - page 61

DPE COMPUTERS (Since 1983)

CMS Computers Plus Inc.
 #209 8th Ave. S.W.
 Calgary, Alberta T2P 0R2
 Tel: 403-237-0870 Fax: 403-237-0871

102-1112 West Pender, Vancouver, B.C. V6E 2S1
 Tel: 604-683-7587 Fax: 604-683-9210

Multiterm is a registered trademark of DPE Electronics Canada Ltd.

CONTENTS

The Computer Paper • B.C. Edition • February 1991

FEATURE

SPREADSHEETS	32
Excel 3.0	32
Ease of use is the focus of this new release of Excel for Windows 3.0. <i>By Graeme Bennett.</i>	
Lotus 1-2-3 Release 3.1	
An optional WYSIWIG interface and mouse support mark the new Lotus. <i>By Steve McIlwain.</i>	
PlanPerfect	37
A spreadsheet for WordPerfect users. <i>By George Slade & Steve McIlwain.</i>	
Quattro Pro V. 2.0	38
Presentation graphics, ease of use and you don't need a 386 to run it. <i>By Kirtan Singh Khalsa.</i>	
SuperCalc 5	39
"If you need complex spreadsheets, SuperCalc 5 is a worthwhile investment." <i>By George Slade & Steve McIlwain.</i>	
F9 Version 1.11	40
Instant retrieval and analysis of ACCPAC Plus G/L from within a Lotus spreadsheet. <i>By George Slade.</i>	
Cantax and Hometax Plus	41
Cantax the old standby gets some competition this year. <i>By Steve McIlwain.</i>	
Spreadsheets For The Mac, Amiga, Atari, NeXT ...	44
The best and brightest on the "other" platforms. <i>By Graeme Bennett.</i>	
Lotus Improv—The Spreadsheet Re-defined	45
The NeXT computer hosts the spreadsheet for the '90s. <i>By William Barr.</i>	

ARTICLES

Mac World Expo	46
A show report from San Francisco. <i>From Newsbytes.</i>	
Pacific Rim Computer & Communication Show	48
Vancouver's biggest computer show brought a host of new products to town. <i>By The Computer Paper Staff.</i>	
The Atari TT	50
Distinctive styling, a fast processor and a quick new operating system for Atari's flagship. <i>By Graeme Bennett.</i>	
Banner Mania	52
Transmogrify your signs with this program for the PC. <i>By Robert Tarrant.</i>	
NEC Ultralite	
The Ultralite for the masses? <i>By Graeme Bennett.</i>	

DEPARTMENTS

Computer Calendar	55-58
Computer Classifieds	59-60
Index of Advertisers	62
Letters to the Editor	7
Masthead	5
What's New	8
NEWSBYTES	14
Amiga World	10
Apple World	10
Canadian News	15
Desktop Publishing	19
General	19
Local Area Networks	21
Laptops	21
IBM World	22
Telecom	27
The Gulf War	28
Unix	28
Windows	29

FROM THE EDITOR

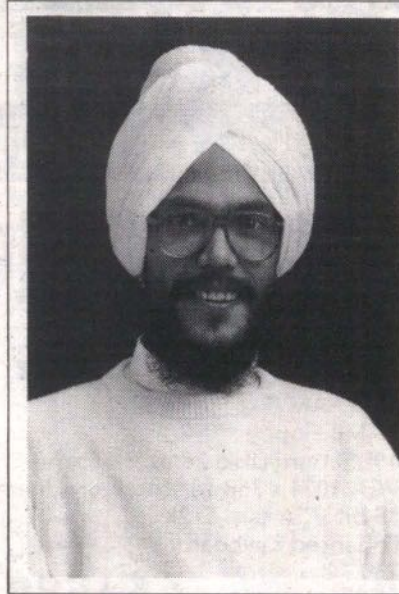

Our Fourth Year

With this issue, we formally enter our fourth year of publishing *The Computer Paper* in British Columbia. (We enter our third year of publishing in Alberta in May.) I would like on this occasion to say thanks to all the people who have made the paper possible—our advertisers, our readers and our staff.

A question often asked of us is "How can you give the paper away for free?" The answer is of course—our advertisers. And the magic words that make them want to keep advertising month after month are: "I saw your ad in *The Computer Paper*, and I would like to buy..."

Some of our advertisers have supported us from the first few issues. Special thanks to these people, who saw our potential and looked past our initial limitations.

I also want to say thanks to all our readers, both new and old, steady and occasional. We hear your comments, we appreciate your suggestions and we love your support. It makes the occasional late night at the terminal worthwhile.

Last but not least, I want to say thanks to all our staff, the people who put endless energy and joy into putting this publication together. Our writers, our production people, our salespeople, our office staff—their names are below in our masthead, but their hearts and souls are in the pages. They put out major efforts to get out each issue, and best of all, they are enormous fun to work with. Thanks, everyone.

Spreadsheets

This month, we take a look at the best-selling spreadsheets. There is something in there for most needs, and all needs may not require Lotus 1-2-3. Tax time is upon us again, and we have a write-up on the two Canadian personal tax preparation software packages. We had promised Canadian Payroll for this issue. Look for it next month.

Subscriptions

I should have started out this column with a "good news, bad news" line. You got the good news about what is in the issue, up above; the bad news is that our subscription rates have gone up. This jump is caused by a combination of the GST (minor impact) and the steady increase in 2nd Class mail rates (up 50% March 1st). I think it is still a reasonable deal at \$24.95 for 12 issues per year (it was \$19.95)

Swap Meet

Shoppers looking for a good buy might do well to check out the Swap Meet being held in the McPherson Centre in Burnaby on February 16 (see page 30).

Kirtan Singh Khalsa

Kirtan Singh Khalsa
Editor/Publisher

MASTHEAD

Publisher/Editor Kirtan Singh Khalsa
Newsbytes Contributing Editors
 Wendy Woods, Wayne Yacco, Dana Blankenhorn, Jon Pepper, Steve Gold, Peter Vekinis, Ken Takahashi, Naoyuki Yazawa, Paul Zucker, and Grant Buckler
Assistant Editor Graeme Bennett
Contributing Writers George Slade, Steve McIlwain, Robert Tarrant, William Barr.
Proofreader Neall Calvert
Office Manager Dharm Kaur Khalsa
Receptionist: Suzanne Byars
Cover Art: Graeme Bennett, Discimagery.
B.C. Ad Sales Hari Singh Khalsa, John Oliver
Alberta Ad Sales Patricia FitzGerald
Manitoba Ad Sales Suzanne FitzGerald
Ad Production Carolyn Howse
Distribution Ken Kemp & Co.
Printer Transcontinental Printers, Printed in Canada
Circulation: 50,000 ISSN 0840-3929

Subscriptions

The Computer Paper is published monthly. If you would like *The Computer Paper* mailed directly to your home, please send a cheque for \$19.95 to Suite 8, 3661 W. 4th Ave., Vancouver, B.C. V6R 1P2 Telephone (604) 733-5596. This will cover mailing and handling for 12 issues in Canada. American subscriptions please send \$35 in US Funds. Overseas please send \$60 Canadian.

This is Volume 4, No. 2, January, 1991
The Computer Paper, Western Canada's Computer Information Source, is published by Canada Computer Paper Inc. All rights reserved. Reproduction in whole or in part without the permission of the Publisher is strictly prohibited.

HEAD OFFICE: Canada Computer Paper Inc. Suite 8, 3661 W. 4th Ave. Vancouver, B.C. V6R 1P2
 Phone: (604) 733-5596 FAX (604) 732-4280
 BBS Number: *Mind Link!* (604) 576-1214
ALBERTA OFFICE: 4th floor, 714 1st St. SE, Calgary Alberta. Tel. (403) 262-5737 Fax (403) 265-5974.
 Edmonton Tel. (403) 459-3554.
MANITOBA OFFICE: 1760 Mathers Ave. Winnipeg, Man R3N 0N6 (204) 949-7720, Fax (204) 949-7721
2nd Class Postage Reg. Number 7718

COMING EDITORIAL SCHEDULE

ISSUE	DISTRIBUTION	TOPICS	COPY	CAMERA READY
March 1991	Mar 1	Desktop Publishing, Laser Printers	Feb 13	Feb 15
April 1991	Mar 29	Telecommunications, Fax Boards, BBS List	Mar 13	Mar 15
May 1991	May 1	Personal Information Managers Laptops	April 15	April 17
June 1991	May 31	486 Computers	May 15	May 17

Canada Computer Paper Inc. Suite 8, 3661 W. 4th Ave. Vancouver, B.C. V6R 1P2
 Phone: (604) 733-5596 FAX (604) 732-4280 BBS Number: *Mind Link!* (604) 576-1214



COMPUTER EMPIRE



CSM MANAGEMENT & CONSULTING INC.

SPRING SALE

386 System 33MHz

- 1MB RAM (Exp. to 16MB)
- 1.2MB Floppy
- 40MB Hard Disk, 28ms, 8K Cache
- VGA 1024 x 768 14" Monitor .28mm
- 16 bit VGA 1MB
- Enhanced Keyboard

\$2388

\$1988

Mono
Monitor

Lease to own \$128/month

386 System 25MHz

- 1MB RAM (Exp. to 8MB)
- 1.2MB Floppy
- 40MB Hard Disk, 28ms, 8K Cache
- VGA 1024 x 768 14" Monitor .28mm
- 16 bit VGA card 512K
- Enhanced Keyboard

\$2088

\$1688

Mono
Monitor

Lease to own \$112/month

386 System 16MHz

- 1MB RAM (Exp. to 4MB)
- 1.2MB Floppy
- 40MB Hard Disk, 28ms, 8K Cache
- VGA 1024 x 768 14" Monitor .28mm
- 16 bit VGA card 512K
- Enhanced Keyboard

\$1788

\$1388

Mono
Monitor

Lease to own \$96/month

AT 286 System - 12MHz

- 1MB RAM (Exp. to 4MB)
- 1.2MB Floppy
- 40MB Hard Disk, 28ms, 8K Cache
- VGA 1024 x 768 14" Monitor .28mm
- 16 bit VGA card 512K
- Enhanced Keyboard

\$1288

\$888

Mono
Monitor

Lease to own \$70/month

Empire Membership

Join our membership and buy computer goods at dealer's cost plus handling charges
649-7281

Computer Rentals

XT System \$48/week
AT System \$68/week
386 System \$88/week
(Ask for monthly discount rate)

NOVELL NETWORKING

Qualified Installers
Reasonable Prices!

CUSTOM PROGRAMMING APPLICATION DEVELOPMENT

C, Lisp, Pascal, Fortran, Prolog, Foxpro, Assembler, PL/1, Dbase

Training & Software support

POINT OF SALE SYSTEM

- Free Estimate
 - Free Consultation
- We have a specialist available to work with you to obtain the best cost effective solution for your specific needs.

SPECIAL CLASS: "HOW TO ASSEMBLE COMPUTERS"

Weekly hands-on class, includes trouble shooting and assembling techniques, certificate will be given upon completion of the course. Advanced registration required.

Why should you buy from us?

- We screen test all our suppliers' products
- One hour walk-in repair turnaround
- On-site service available
- Five years warranty available
- Professional after sale technical service

JOB OPENINGS

Experienced Salespersons required for our expanding Corporate Sales Division
Call 649-7281

TECHNICIAN'S SPECIAL

Hard Disk \$80
Floppy Drives \$20
Monitor \$35
AT Motherboard \$60

Enquire about our Five Year Warranty Plan

649-7281

DEMO CLEARANCE SALE

All Demo Units Must Go.

**FREE DRAW
386 Computer**
Also get our scenic 1991 calendar FREE (just drop by our store).



Sales: 872-1668 Service: 879-4162

Membership: 649-7281 Fax: 874-1668

3031 Main St. Vancouver, B.C. V5T 3G6

Hours: Mon-Sat 9:30 am - 6 pm

LETTERS TO THE EDITOR

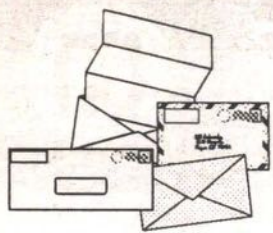

**Where To Find
The Computer Paper**

I just happened to find *The Computer Paper* Manitoba Edition January 1991 Vol. 1 No. 1 Premiere Issue in of all places the men's room at work. I read it from cover to cover and enjoyed it very much. I am sending my subscription. Can you please ensure that I receive the February issue, even if you send it late.

Thanks
Richard Proulx, Winnipeg, Manitoba.

Fax and Scanners

Can a fax machine be used as a scanner for the computer?

I have a Laser 286 computer w/640K RAM and 40 MB hard drive, a DataTrain DM1200A modem and a NEC System III-T fax (an older machine). Is it possible to install a FRECOM FAX96 card in my computer and use my fax to scan documents to be further manipulated by the WordPerfect 5.1 program? I am also interested in scanning images (i.e., letterheads, drawings, etc.) for further manipulation within my text. I would be most pleased to receive your response how to achieve this task and also learn what or if other software may be needed and its cost.

S. F. Sverre, Vancouver, B.C.

Yes, I remember reading of a product announced at Comdex that plugged into a fax and a computer allowing the fax to be used as 200-dpi scanner. A stand-alone fax machine called Tefax from Relisys already does this, as well as being usable as a printer, copier and fax modem. However, 200-dpi is not particularly great resolution, and an add-on box is definitely required to access the scanner hidden within your fax machine, if, indeed it can be accessed at all. Another alternative might be to purchase a low-cost hand scanner like the 400-dpi Logitech SCANMAN PLUS (\$249)? Besides having double the resolution, it features gray scale and editing software, too. It will do all the things you want for around \$300.

Help Wanted

After reading *The Computer Paper*, I'm convinced that you might be able to assist me. I am a 46-year-old writer of children's stories and am also interested in animation. I have never owned a computer but had an opportunity to play with a Macintosh about six years ago.

Recently I've been considering purchasing a computer. I have talked to Atari, Radio Shack (Tandy) and Amiga owners. They all recommend the computers they purchased. Their packages all cost \$1500-\$2000 complete.

I am totally confused. Can you recommend computers to me that may be appropriate for someone who likes to dabble in animation and needs a package with good word processing programs. My purchasing power is \$750-\$1500. What about clones? Your help would be appreciated.

Michael Taenzer
Rossland, B.C.

You could do credible animations with any of the computers you mention, but only the Amiga has the innate ability to remove the borders from its screen, using a feature called overscanning. If you videotape an Amiga animation, no annoying frame appears on the output. With only \$750-\$1500 to spend, consider getting an Amiga 500, RAM expansion and color monitor (about \$1200). Then you could invest the remainder in software. A good wordprocessor is ProWrite, a good Animation/paint program is Deluxe Paint III. My only recommendation is to consider getting either a hard drive (about \$700) or second floppy drive (about \$200). Although this will blow your budget by a few hundred dollars, most users will agree that having two drives makes Amiga file-handling much easier.

Help For The Handicapped

First, let me take this opportunity to thank you for your fine paper which I have appreciated for several months now.

Secondly, regarding the request from the Burnaby Association for the Mentally Handicapped, there is an organization in the U.S. which runs a program for matching computers which are donated to non-profit organizations which could benefit from them:

CRISTINA, named by a father for his daughter who was able to utilize a computer successfully to assist her in overcoming some debilitating physical limitation.

Their U.S. 800 number is 1-800-CRISTINA.

Having worked with non-profit charitable organizations on both sides of the border, I understand there may be some differences in how the system might work in Canada. However, the concept sounds like a great one and could be rewarding to the donor and appreciated by the receiver.

Layne Daggett 274-6936

BBS Listings

In one of your past articles, you were discussing the merit's of BBS's, and how they can be useful to new users of all types of computers. Have you considered running a small free classified in the back of your paper for private BBS ad's? Even if they were just a 3-5 line small type ad, it might give some potential modemers a place to start looking. Something like this.

The WORPFactor BBS. 3/12/2400 baud, 24 hrs. 322-9677 / 322-WORP - IBM/ST Support. (Just happens to be my BBS.. ahem..)

You could also run a small one paragraph on-going breif summary of the general concept behind modeming. Just a thought....Thanks for a great paper!
John Craker via Mind Link!

The April edition of *The Computer Paper* we plan to run another free BBS list. If you have a BBS that we should know about, you can fax us your information at 732-4280, or send us an E-Mail message on Mind Link!

As for running it in every edition—not a bad idea. We have the space and we have the headings, now all we need are the customers. \$7/line and you can order by phone at 733-5596 or fax us at 732-4280. Have your Visa or MasterCard number ready, or mail us a cheque in with your listing to Suite 8, 3661 West 4th Ave., Vancouver, V6R 1P2. Please specify how many issues you would like it to run in.

Our name stands for Superior Quality and Service . . . at a reasonable price.



Would you like to Recycle your toner cartridges, but had a bad experience in the past? Does your toner cartridge leave black lines or smudges along the side of the page? Is your toner density too light?

Don't throw it away!

call SUPERIOR LASER SUPPLY
we have the answers

**100% SATISFACTION GUARANTEED
OR YOU DON'T PAY!**

Recycle Your Toner Cartridge

SUPERIOR LASER SUPPLY
Your Recharge Specialists



463-3331
Standard Recharge

Do you wish someone would make a toner cartridge to last longer?
Are you looking for a company that stands behind their products 100%?
One that you can deal with in confidence? Look no further.

\$59.95 ONLY

Hewlett Packard Toner Cartridge
for all Canon Based engines
\$119.00 plus exchange

Remanufactured Toner Cartridge
guaranteed for at least 6 recharges
\$119.00 plus exchange

CALL, Call, Call for super pricing on all Laser and Data Supplies

WE OFFER LASER PRINTER CLEANING SERVICES **\$39.95**
OR FREE WITH ANY PRE BUY OF 5 OR MORE RECHARGES CALL FOR DETAILS

Expandable Memory Boards
1MB \$199 2MB \$259 4MB \$435

Postscript HP
Cartridges Laserjet III
\$499 \$2199

Many More
Products and
Brands Available

942-5512

All Prices Include
**FREE Delivery in
Greater Vancouver**

Can You See
10 Million Dots?

Pender Office:

- announces fast, high resolution output up to 3386 dots per inch from our new Linotronic L330 Imagesetter - over 10 million dots per square inch!
- L500 provides extra wide, high resolution output up to 18" by 4' to film and paper
- full colour laser printing
- quality typesetting, design and production programming

Hastings Office:

- Mac and PC workstations
- self-service laserprinting
- DTP specialists for hardware, software and peripherals - offering sales, advice and support

Both Offices:

- Mac and PC environments
- disk and file conversions
- scanning for text, line art and photographs
- service with a smile

- Monday to Friday 9-5 pm and Saturday 10-3 pm
- 830-789 West Pender St. Vancouver V6C 1H2 Fax (604) 681-2300 Modem (604) 681-3278
- 716 West Hastings St. Vancouver V6C 1A3 Telephone (604) 682-5443 Fax (604) 682-4103

Laser's Edge
(604) 662-3774

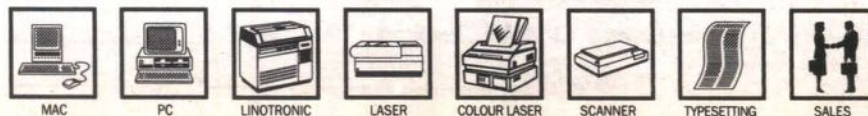

Low Cost Printer Sharing



As low as
\$179.00
MSRP

SmartPrint
Falcon
IIeasyPrint

The Price-Performance Winners

- Fully automatic switching
- No waiting while other print jobs finish
- Choice of models with buffer or disk spooling
- Inexpensive phone wire can be used for serial connections
- Manufactured in USA

Distributed by

Impaq Technology Inc. 261-1800 (Vancouver)
or 800-663-9272 (Canada-wide)

Dealer Inquiries Welcome



Fax: (604) 263-9201

Technology with Impact and IQ

Enjoy the convenience of having The Computer Paper delivered to your door.

Keep up to date with the latest in the computer industry. Subscribe at \$19.95 for one year (12 monthly issues) and enjoy *The Computer Paper* delivered to your door each month.

* \$35 for U.S. Subscriptions, \$60 for Overseas
The Computer Paper, Suite 8, 3661 West 4th Ave.,
Vancouver, B.C. V6R 1P2
Tel: (604) 733-5596 Fax: 732-4280



COMPUTER PAPER
WHEN CHASING COMPUTER INFORMATION SOURCE

Yes, I want to subscribe to The Computer Paper, I pay just \$19.95 for 12 monthly issues. The Computer Paper, Suite 8, 3661 West 4th Ave., Vancouver, B.C. V6R 1P2 Tel. 604-733-5596



Name _____ Address _____

City, Prov., Postal Code _____

PAYMENT Payment Enclosed VISA Mastercard Card Number _____

Name on Card _____ Phone: _____

Expiry Date _____ Signature _____

WHAT'S NEW



Looking Sharp

One of the best things about computer trade shows are those exhibits that are so great, that everyone just stands there saying "Gee whiz!" One such wonder was to be found at Vancouver's Pacific Coast Computer & Communication show, in the Sharp Electronics booth. Their new color VGA 386 laptop had a display so spectacularly brilliant, everyone more or less agreed: "Who cares how much it costs?" Easy for them to say, but if you want one, it goes for about \$18000. Now who wants one? Contact Sharp at 416-890-2100 about this near-ultimate status symbol. Teleportation

Teleport, the 2400-baud modem for Macintosh that doesn't take up a serial port (it plugs into the Mac's "Desktop Bus" port instead) now comes in a version that adds send-fax abilities. Dubbed the TelePort/Plus 2, it is distributed by Just Fax Ltd.

The company also carries a variety of voice/modem/fax switches that alleviate the need to have more than one phone line, including the Fax Line Manager from Technology Concepts. Their phone number is (403) 221-7329, fax (403) 211-7330.

LC Grows Up

Apple's new Mac LC low-cost color computer is, by all indications, looking like a smash hit follow-up to the Classic buyers' frenzy of the Christmas season. Announced at MacWorld Expo in January were several add-ons that help to put a bit more pep in its step. Would you believe a 68040 upgrade for the diminutive LC that gives it (considerably) more horsepower than a Mac IIx? At that show, Apple announced several Ethernet cards, including an LC model for C\$265. See the MacWorld report this issue for details.

Hyper Upgrade

Readers may recall our November '90 issue, where we described a technique to "uncripple" the version of HyperCard 2.0 bundled with new Macs. Interestingly, a recent Claris press release points out that "Like all previous versions of HyperCard, the HyperCard 2.0 bundled configuration is set to the 'Typing' level of access, which allows users to browse through stacks and enter text. However, users can change the access level to operate within the program's highest user levels." Sure guys, except the other versions included instructions on how to do it and didn't hide the higher access levels behind invisible boxes.

At any rate, Claris is now selling the

HyperCard 2.0 Upgrade Kit for C\$69. Order it by calling 800-668-8948. A \$259 developer's kit is also slated for release by the time you read this.

The company has also announced an upgrade of its popular MacDraw program, which according to a recent survey by International Data Corp., enjoys almost 50% of the market for Macintosh illustration software. Notable enhancements include improved color support, gradient fills and file-exchange capabilities. The \$529 package will be shipped in late spring. Current MacDraw owners may upgrade for \$129.

Taito Leaves, President Moves On

Citing "a number of new hardware technologies including high-speed processing, data/video compression and optical storage that will soon be readily available for the mass consumer markets [that will] fuel demand for more sophisticated software than what is currently available," Taito Software, Inc. president Alan Fetzer has resigned to form a new business venture focused on "new and emerging technology in the entertainment software industry." Fetzer's resignation comes at a time when Taito, a leading producer of Nintendo games, is closing its North Vancouver offices and relocating its North American operations to Wheeling, Illinois. Fetzer indicated that discussions with off-shore investors are currently underway. Contact: Jeff Macler (818) 783-1688.

Compaq & Banyan Ink Deal

Compaq Computer Corporation has announced that it has signed a joint integration agreement with Banyan Systems, Inc. that will establish a formal framework for their ongoing efforts to assist customers in multi-vendor, wide area network, PC-based solutions.

Contact Compaq at (416) 733-7876 or Banyan at (508) 898-1000.

Top Producer Slashes Price

The area of Personal Information Management software is one that *The Computer Paper* is slated to explore in our May 1991 issue. Some of these programs are specifically for client management, and even more specifically, some are for specific professions.

One such program is Top Producer, a client management program designed for the working realtor. Named an officially approved software supplier to both RE/MAX International and RealtyWorld Canada, and recently judged the best in Canada by members of the Canadian Real Estate Association, Top Producer previously sold for \$1495. In an effort to establish it as an industry standard, Top Producer Systems, Inc. has slashed the price to \$495. Contact 604-270-8819.

Xerox Distributes Hot Product

Lava Computer Products Inc. of Toronto has announced that their line of serial, I/O, EGA, VGA and MicroChannel Architecture boards are to be exclusively distributed by Xerox Canada. Lava's products are said to be the only Canadian computer boards with a lifetime warranty. Contact James Gingerich 416-674-5942.



Up Tempo

A new notebook computer weighing less than 7 pounds has been announced by Everex. Dubbed the Tempo LX, the 16 MHz, 386SX-based unit comes standard with 1MB (expandable to 3 or 5MB) and includes a 1.44MB floppy and a 21MB hard drive. The unit includes a 10-inch VGA-compatible LCD display, serial, parallel and external VGA monitor ports. A 2400-baud modem and additional battery packs are optionally available. The Tempo LX is distributed locally by CMOS Marketing Ltd. (604) 736-6661.

Mac Mouse For Three-Fingered Unix

Mac owners who must by now be getting tired of having sand kicked in their faces by other multitasking operating systems can now upgrade to Apple's version of Unix, A/UX 2.0. The only snag is that Unix all-but-requires a mouse with more than one button. What's a Mac to do?

Enter the Gravis SuperMouse for SE and Mac II-series machines. The SuperMouse enables you to assign and modify mouse button actions, change mouse speeds and emulate keystrokes to invoke menu functions or launch macro sequences. QuicKeys Lite by CE Software is bundled with the unit, which closely resembles a Logitech C7 mouse.

Although many were surprised that accounting software giant Computer Associates didn't exhibit at the Pacific Rim Computer & Communication Show, the company has not been idle. Just announced are a number of changes to its ACCPAC Bedford entry-level accounting program for MS-DOS and Macintosh computers.

The new versions (ACCPAC Bedford for MS-DOS version 3.4 and ACCPAC Bedford for the Macintosh version 1.2) have a new lower price of C\$225 and are now fully GST-compliant. In addition, the company is offering ACCPAC Bedford Graphic and Custom Reporting for MS-DOS at no charge to users upon registration. Contact Computer Associates 604/733-2343.

Suzy Doubles Price

Version 3.0 Suzy software has been released by Stratford Software, with an increase in price to \$59.95. Previously, version 2.0 had retailed for \$29.95. Defending the increase, Stratford's vice president of marketing Sharka Chobot said that "the added functionality in version 3.0 makes the Suzy user program very good value for users at \$59.95."

The new version supports the use of a mouse and is said to substantially streamline Suzy's online navigational features. Reportedly, the new version also allows advanced configuration of modem parameters not possible in earlier versions. A French-language version is also being readied for release.

Users in the Vancouver local calling area no longer need to call the national

Datapac access number. Also, the new version allows the use of alternative packet-switching networks, notably the Tymnet communications network, which can be accessed in a number of major cities with a local telephone number.

Existing Suzy users can download the new version to their IBM-compatible computer while connected to Suzy. Connect charges to download the upgrade amount to approximately \$3.00 at 2400 baud, or \$6.00 at 1200 baud. A Suzy representative said that support for other types of personal computers is not planned at this time.

For further information: Sharka Chobot, Marketing Manager, Stratford

Software Corp. (604) 439-1311 or write to #2047-4710 Kingsway, Burnaby, B.C. Canada V5H 4M2.

Are We There Yet?

In what can only be described as a gutsy move, the Fraser Valley Credit Union, a \$260 million, 30,000-member financial institution (one of the ten largest Credit Unions in B.C.) has switched their entire database of over one million transaction records to a network of low-cost PCs.

According to John Charlesworth, Fraser Valley's Chief Executive Officer, the system, called the Prologic Banking Solution, was selected because of its

unique ability to enhance customer service. Expected to allow the Credit Union better control over its own database and customer records, the system also includes an integrated G/L package. Using a Client/Server architecture distributed network, the system is said to allow users virtually instant access to account records.

The system of 140 workstations runs completely on IBM-AT compatible micro computers, with a 386-based machine acting as the host system. Data is stored on large hard drives of 760 megabytes each, and is backed up (often, we hope) on magnetic-optical disk drives.

Contact: Rob Murray, Communica-

Q: What business computer means business to your business?

Answer: Q.

At last, an IBM-compatible business computer that answers questions rather than asks them. Our new high performance Q computers are designed and engineered in North America to meet the demanding needs of today's businessman and woman. If your business means as much to you as we think it does, a look into Q business computers may be the best business decision you will make. For quality, high performance, and surprising affordability, Q stands apart from the rest in the field and is backed up by a two-year limited warranty and a service department that makes sure your business never has to wait.

If you are in business to stay, stay with Q for the answers. Q Personal Business Computers. Quality by design. Award-winning. FCC and UL approved.

See us at Oxford Computers (Caulfeild Village, West Vancouver. Telephone 922-2447), or visit our downtown showcase today (Suite 304 - 700 West Pender Street. Telephone 685-7003).

Dealer inquiries are welcome.



The Business Computer that Means Business.

Javell Enterprises International, 304 - 700 Pender Street, Vancouver, British Columbia V6C 1G8
Telephone: (604) 685-7003 Fax: (604) 688-9611

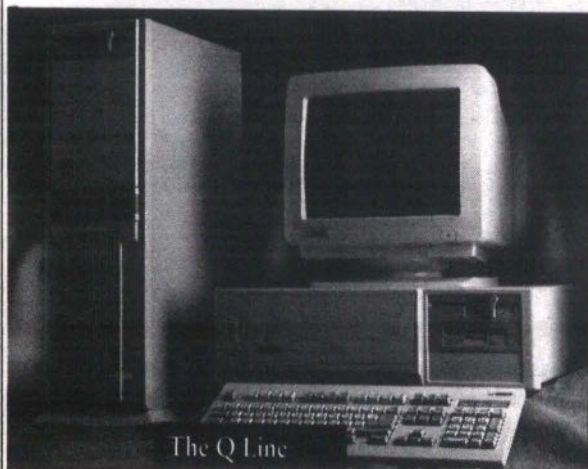

Q486/33 Cache	Q386/25 Cache
Q486/25 Cache	Q386/20 Slimline
Q386/33 Cache	Q386sx Slimline
Q386/33 Baby Cache	Q286/12 Slimline

tions Manager, Prologic Computer Corporation (604) 278-6470 or Dave Tomlinson, Manager, Planning and Support Services, Fraser Valley Credit Union (604) 853-4831.

Top This Act

Richmond Software tells us that their Maximizer 2.0 program recently topped ACT! 2.0 in a comparative review in *InfoWorld* magazine. Now shipping is Maximizer 2.1. Look for a review in the May issue of *The Computer Paper*. Contact Richmond Software at (604) 299-2121.

The Sound of Music

In case you hadn't heard, 1991 is British Columbia's official Year of Music. Here are a few goings-on:

- Feb. 28-Mar. 3, **Westex**, the West Coast Music Exposition at the Robson Square Conference Centre. A new-technology exhibition and trade show, Westex will feature product demo clinics, workshops and panels, as well as various live showcases.

- Sunday, March 3, the **Juno Awards**—for the first time ever in Vancouver.

Contact Laurie Mercer or Louise McLeod-Stewart (604) 684-9338.

GST Price-Cuts

In response to the introduction of GST, many computer companies, including Dell Computer Corp. and Compaq, have announced price reductions of between 5 and 7.5% on their entire lines of computer systems. Contact Susan Kendall, Dell (416) 764-7364 or Compaq (416) 733-7876.

Amiga World

Commodore Makes Changes, Cuts

NEW YORK, NEW YORK, JAN 8 (NB)—Commodore International has shuffled two senior executives and announced cuts in its U.S. operations. Commodore appointed James Dionne as general manager of its U.S. sales company, succeeding Harold Copperman, who has been appointed vice president of Commodore International, with new responsibilities including Amiga multimedia strategies.

Dionne has been with Commodore 11 years, most recently as general manager of Commodore's Canadian subsidiary. Copperman joined Commodore in 1989.

James McWhinnic, formerly executive vice-president of finance and operations at Commodore Canada, will replace Dionne in the top job at the Markham, Ontario-based subsidiary.

A spokeswoman in Commodore VP of Finance Ron Alexander's office confirms published reports that fiscal year 1990 earnings were \$1.5 million, down 97 percent from last year. At press time it wasn't clear whether this figure referred to the Commodore Business Machines division or the Commodore International mother company.

Commodore also announced a reduction in the manpower of U.S. operations, primarily in administration and factory overhead. Commodore did not respond to calls in time for Newsbytes'

NEWSBYTES

deadline, but United Press International reported the company plans to lay off about 10 percent of its 600-strong U.S. workforce. This action is partly due to the reorganization of certain functions and is expected to result in improved operating efficiency, the company said. Contact: Commodore International, 215-431-9100.

Apple World

Aldus Announces Freehand 3.0

SEATTLE, WASHINGTON, JAN 2 (NB)—Aldus has announced Aldus FreeHand 3.0, a major new release of its design and illustration program for the Macintosh. The US\$595 program had its first public showing at the Macworld Expo in San Francisco January 10.

Aldus adds that FreeHand 3.0 offers improved performance that makes the program feel smoother, move faster, and offer more precision than ever before. The program also includes a built-in color separator that produces full process-color separations for all parts of an illustration, including imported 32-bit color TIFF images.

The new version is set to ship in the next three months. Upgrade pricing for existing users is US\$150, but those who purchase version 2.0 of Freehand between now and the ship date can upgrade for an additional US\$50, according to an Aldus spokesperson. Contact: Aldus, 206-628-6674.

Microsoft Mail 3.0

REDMOND, WASHINGTON, JAN 17 (NB) — Microsoft has announced version 3.0 of its Mail network-based electronic mail package for AppleTalk networks, combining performance enhancements with new features requested by the users.

Major new features include unlimited file attachments for mail messages, and personal address books of the people corresponded with most often, which the system can update automatically as changes are made in the network.

A dial-in feature has been added so users can access their messages from remote terminals. Custom message folders can be created to organize correspondence. New administrative tools include automatic backups, automatic deletion of older messages, and network statistics.

The suggested retail price of the Microsoft Mail Server is \$395, and workstation versions cost \$395 for five or \$1,395

NEWSBYTES News Network is the largest independent computer industry news service in the world, published continuously since May, 1983, with 4 U.S. and 7 international bureaus in London, Brussels, Toronto, Tokyo, Hong Kong, and Sydney, Australia, devoted to gathering the week's most significant microcomputer and consumer technology news. NEWSBYTES was honored to receive the "Best Online Publication" award from the Computer Press Association. Editor In Chief: Wendy Woods. Janet Endrijonas, Dana Blankenhorn; John McCormick, John and Barbara McMullen, Steve Gold, Peter Vekinis, Ken Takahashi, Naoyuki Yazawa, Paul Zucker and Sean McNamara, Keith Cameron, Norman Wingrove, Kirill Tchashchin.

Introducing the Intra LT-386SX Laptop

SAVE THOUSANDS OF DOLLARS!

An extra compact design 386SX laptop (weight only 4.9 kg and 6 cm high), similar in dimension and weight to a letter size notebook pc, but much more powerful than a notebook. Compatible with 80x86 software, OS/2, MS-DOS, Unix, Xenix, Windows 2.x/3.0, AutoCad, Novell, Laplink, Ventura, DESQview, DBase III/IV, Lotus 123, Carbon Copy, and many more. High resolution 640 x 480 VGA display. Features a dot pitch of only 0.27mm. 16 grayscale, background reversable, supports external VGA monitor. Long battery life, keeps about 3 hours of continuous operation and with a fast charge function of within 3 hours. Display panel can be folded down to a flat position enabling you to directly see the external monitor's screen in front of you. Uses double sided SMD subassembly technology to guarantee a high quality and reliability. All internal parts manufactured in Japan. Two full year warranty on labour. One year on parts.

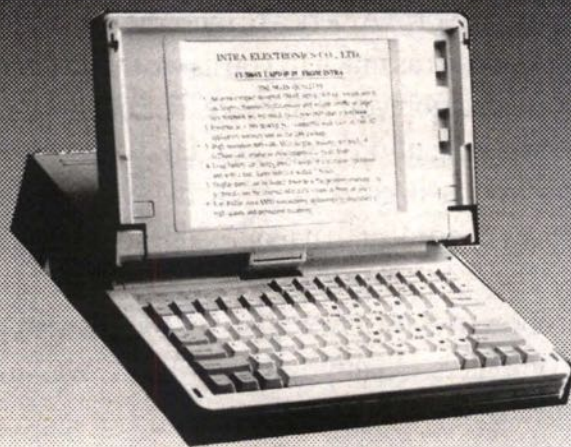

INTRA LT-386SX	
CPU	80386SX
CO-PROCESSOR	Socket for 80387SX
MEMORY	2MB RAM Standard Expandable to 6MB, supports SHADOW RAM
HARD DRIVE	41MB (18ms)
FLOPPY DRIVE	1.44MB 3 1/2"
INTERFACES	1P, 1S, VGA Monitor Port, Ext. D. Port, Ext. Keyboard Port
EXPANSION SLOT	1 Proprietary
KEYBOARD	85 Keys
DISPLAY	640 x 480 LCD 0.27 Dot Pitch, 16 Grayscale, Background Reversible
OPTIONS	Ram Upgrade
	2MB SRP \$400
	4MB SRP \$800
POWER SUPPLY	NiCad Battery & AC Adptr./Recharger
DIMENSIONS (WxDxH)	12.8" x 12.4" x 2.36"
WEIGHT	10.9 lbs.
SUGGESTED RETAIL PRICE	\$4,950
SELLING PRICE	\$4,950



OMNINET
COMPUTER LTD.

(604) 872-1136 FAX: 872-1136
3728 MAIN ST., VANCOUVER V5V 3N7
DEALER ENQUIRIES WELCOME



CONTACT DEALER FOR INFO

CONTACT DEALER FOR INFO

Strachan Computers
1336 Main St.
North Vancouver 984-8500

Compukits
4320 Fraser St.
Vancouver 879-9288

Morse-Tech Communications
1237 West Broadway
Vancouver 738-3288

Werner Computers
148 Lakeshore Dr. N.E.
Salmon Arm 832-3288

Canada Portable Computer
#204 20189 56th Ave.
Langley 534-6441; 1-800-663-1061

Infospec Systems
#101 2806 Kingsway
Vancouver 430-1223

COMPUMAX

102-1668 WEST BROADWAY,
VANCOUVER, B.C. V6J 1X6

731-2828

An **Affordable** Solution

NOVELL

CUSTOMIZED SOFTWARE

MAINTENANCE UPGRADE

MULTI-USER APPLICATION

COMPUTER TRAINING

RENTAL & LEASING

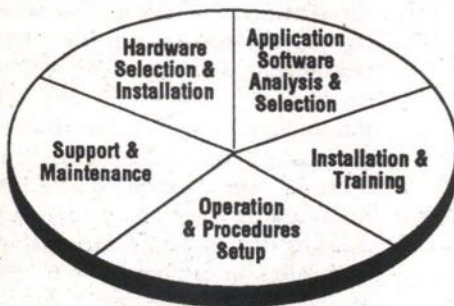

AUTHORIZED
NOVELL®
NETWORKING
ACCPAC PLUS
EXCELLOR®
BUSINESS
MACHINES
Setup & Support
Package



EXCELLOR® BUSINESS MACHINES

Leading edge in technology, powerful 386 and 486 based computers for business and engineering applications.



ORDER/INVOICE/BACKORDER

- Comment line for instructions or comments
- Quick response as P.O.S.
- Add new customer data to master file while invoicing
- Quick list for customer and item
- Add new item data to master file while invoicing
- Real time credit limit check for accuracy
- Real time update for accounts receivable and inventory
- Cost display on screen option
- Cost access option
- Recall order or invoice for enquiry
- Modify invoice with full audit trail
- Enquiry for sales history by customer, item, or salesperson
- Print customer list
- Print price list
- Enquiry and reports
- Sales reports by customer, salesperson and item
- Print invoice and payment journal
- Quick search for backorder
- Backorder report by item

ACCOUNTS RECEIVABLE

- Quick payment and editing
- Full integration with sales
- Real time update accuracy
- User specified aged balance receivable data
- Interest charge function and report
- Payment history statistics
- Print receivable statements
- Print receivable summary and call list

COMPUMAX COMPUTER SYSTEMS
AUTHORIZED DEALER

MULTI EXPRESS

SOFTWARE FOR EFFICIENT OPERATIONS
BY BTI TECHNOLOGIES INC. 732-9499

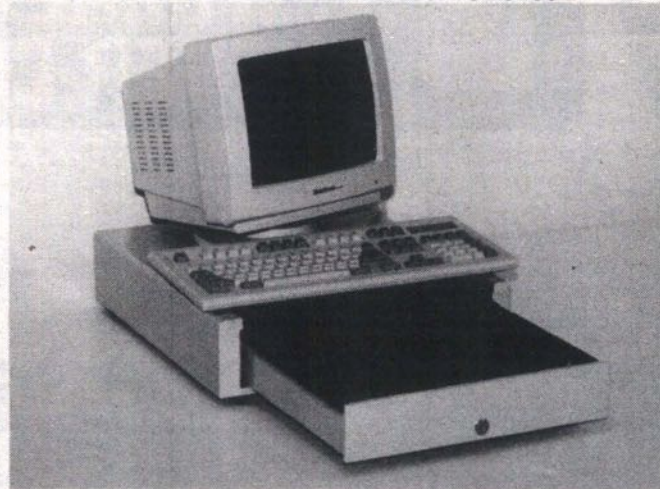

Point of Sale
Order/Backorder
Invoicing
Inventory Control
Service Management
Rental and Return
Accounts Receivable

G.S.T. Support
Single Entry Operations
Full Integrated System
Real Time Update Accuracy
Multiple Level Password Security
Quick List on Database
Multi-user Expandable

POINT OF SALE

- Recall customer by ID or from quick list
- Select item by ID, bar code, or from quick list
- Easy modification of Data
- Password security for different IDs
- Cash drawer control
- Print or reprint receipts
- Accept different payment methods
- Accept multiple deposits and payments
- Integrated to accounts receivable
- Handles P.S.T. and G.S.T.
- Cashier reports
- Handles discounts by percentage or amount

SERVICE/RENTALS

- Order type for service and rental
- Quick search for service and rental
- Easy to locate by outstanding or completed status
- Automatically integrated to sales history and accounts receivable

GENERAL AND ADVANCED FEATURES

- Automatic order number and invoice number for audit trail
- Allows modification of data with audit trail
- Full sales report for management
- Single entry from order, sales, and accounts receivable to accounting
- Multi-user option for growth
- Data integration protection features

SPECIAL

COME & SEE US

MORE SPECIALS IN RETAIL DEPARTMENT

COMPUTERS

286-12MHz	\$699
386-SX	\$999
Everex Step 386	\$Call
DataTrain 2112	\$899
DataTrain 3016	\$1688
AST Bravo 386	\$Call
AST Premium 286	\$1599
AST 486 EISA CUPID	\$Call
Atari Portfolio	\$Call

OVER 300 GAMES
ALL 10% OFF
ALL BOOKS
20% OFF
BULK DISKS HIGH DENSITY
HD 5.25" \$8.99/pk of 10

SOFTWARE

Grammatik IV	\$79.95
Maximizer (ver. 2.2)	\$169.95
Supercal 5 - Special	\$179.95
PCTools Ver. 6	\$99.95
MS Pageview	\$39.00
Deskview	\$129.00
Laplank III	\$89.95
Copy II PC	\$29.95
Formworx	\$196.00
Lotus 123 Ver. 3	\$399.00

Lotus 123 Ver. 2.2	\$398
ACCPAC Plus G/L Ver. 6, etc	\$619
ACCPAC Graphic Report Opt'n	\$109.00
ACCPAC Bedford	\$129.00
Check It Ver. 2	\$109.95
Corel Draw V.2 w/Video	\$549
LAPTOPS	
Portable Power	\$195
(Convert from 12DC - 110DC Volts)	
Mitsubishi 286-20MB	\$2330

JOIN THE WINNING TEAM
JOB OPENINGS

Experienced salesperson, technicians wanted. Please send resume with salary expectations to our Human Resources Dept.

PRICES SUBJECT TO CHANGE WITHOUT NOTICE. LIMITED QUANTITY

We Think Small



Lynda L. Seigneuret



Jacques Seigneuret

Owners of today's small businesses face greater challenges than ever before.

Like minimizing taxes, developing financial controls and determining business strategy and direction.

At Healey Seigneuret & Co. we work with you throughout the year providing objective advice and conscientious support to help you manage your growing business more effectively.

ACCOUNTING, TAX & ADVISORY SERVICES FOR YOU & YOUR BUSINESS

- Year end financial statements
- Bookkeeping & payroll services
- Corporate & personal taxes
- Business planning
- GST consulting

**HEALEY
SEIGNEURET
& Co.**

CHARTERED ACCOUNTANTS

Oakridge Centre
500 - 650 W. 41st Ave.
Vancouver, B.C.
(604) 266-0212

for 20. A PC version of the workstation software is available for \$395 for five units. Current users can upgrade for \$75 for server software, or \$12.50 for workstation software. Contact: Microsoft, 206-882-8080.

Canon's Bubble-Jet Printer For The Mac

TOKYO, JAPAN, JAN 9 (NB)—Tokyo-based office equipment maker Canon will supply its latest "bubble-jet" printer for Apple's Macintosh computer. The OEM-deal is expected to be officially signed this month.

Canon's bubble-jet printer for the Macintosh will be a modified version of the company's notebook-type printer dubbed the "BJ10" and is expected to be equipped with outline font technology. The print quality, therefore, is expected to be nearly as good as that of the LaserWriter II NTX-J. The list price is expected to be less than 100,000 yen (\$770).

The bubble-jet printer is an improved version of an ink-jet printer. Canon has already developed and has been marketing a bubble-jet printer for Japanese personal computers such as the NEC PC-9801, the Toshiba J3100 and the EPSON PC-286.

Canon has been the supplier of Macintosh laser printers to Apple Computer on an OEM basis. Contact: Apple Japan, 03-3224-7000.

Apple To Add Electronics Stores To Retail Mix

SAN FRANCISCO, CALIFORNIA,

JAN 11 (NB)—Apple will try to add consumer electronics stores to its mix of distribution channels, said Robert Puette, president of Apple USA.

Outlining Apple's U.S. service and support strategies at a press and industry analyst luncheon before MacWorld Expo, Puette noted that the new low-end Macintoshes have sold more in the first quarter since their introduction than the Macintosh Plus did in its best full year.

To address the vastly different markets into which the Mac is selling, Puette said, Apple USA will segment distribution into three pieces: the low-cost, high-volume stores with minimal support; computer stores selling into small and large businesses; and highly value-added resellers providing custom integration and consulting.

He described the high-volume stores as electronics and warehouse type operations. He maintained, however, that those stores would still be required to provide service, if only minimal support.

"Service today means taking care of the hardware," Puette said, providing installation and repair service. He contrasted service to support, which he characterized as providing software and operations assistance. Macintoshes, Puette said, would have an increasing amount of "built-in support," assisting users in setup and initial use by using high-quality documentation and a new training disk included with every system.

Apple's quest for sales in the mass market puts it in a segment of the market that has been difficult for other computer manufacturers to crack. PC clone manufacturers such as HeadStart and

SOVO

COMPUTER CENTER

WHERE GREAT SERVICE NEVER COSTS YOU MORE



DataTrain



GOVERNMENT & CORPORATE PURCHASE ORDERS WELCOME!
AUTHORIZED AST SERVICE CENTRE

Datatrain DPC 3017

Best Value on the Market

INCLUDES:

- 2MB RAM • 1.2MB 5.25" Floppy Drive
- 80386SX microprocessor, 16 MHz • Enhanced Keyboard
- 2 Serial, 1 Parallel Ports • Novell Compatible
- VGA Built in • MS Windows/Mouse
- VGA Monitor (1024x768 .28mm Dot Pitch)
- MS DOS 4.01, GW/BASIC Software
- 40MB Conner Hard Drive • Two Year Warranty

\$2,195

AST 486/Bravo

Best Performance

INCLUDES:

- 2MB RAM (Expandable to 16MB) • 1.2MB 5.25" Floppy
- 1486 microprocessor, 25 MHz, 32-bit Architecture
- 80387 Co-processor Built in • AST Keyboard
- DOS 3.3 • AST Utilities Software
- AST VGA Monitor • Mouse Port
- 2 Serial, 1 Parallel Ports
- 100MB Conner Hard Drive

\$5,295

ASI 286 / 12 Home Starter Kit

INCLUDES:

- 80286 microprocessor, 12MHz • 1MB RAM Memory
- 1.2MB 5.25" Floppy • Enhanced Keyboard (101 Keys)
- Monographics Card • Hi-res 12" Monochrome Monitor
- Novell Compatible • 1 Serial, 1 Parallel, 1 Games
- Western Digital 40MB Hard Drive

Add \$395 for VGA Card & Monitor

\$875

Hardware/Software BEST PRICES

ACCPAC BPI	\$270
Corel DRAW! v2.0	\$465
dBASE IV	\$330
PageMaker	\$580
Quicken	\$45
WordPerfect	\$275
HP Laser III	\$2349
Sound Blaster	\$219
Summagraphics 12x12	\$480

• PRICES SUBJECT TO CHANGE WITHOUT NOTICE •

#110 - 2691 Viscount Way, Richmond, B.C. V6V 1M9
Tel. 270-4800 Fax 270-4808

Packard Bell have in recent years been targeting electronics stores as a distribution channel, but have been forced to erode their own margins and provide support through third-party providers.

In moving toward electronic stores, Apple also goes against past and current practice for the company. Apple has always sold only through storefronts and consultants, and has been aggressive in its refusal to merely push boxes—especially through the grey market.

Campbell Leaves Claris For GO

FOSTER CITY, CALIFORNIA, JAN 18 (NB)—Bill Campbell has been named president and CEO of Go Corporation, leaving a similar post at Claris Corporation. The 50-year-old executive takes the helm just as Go prepares to announce a new pen-based operating system, January 22.

Campbell, prior to joining Claris, was executive vice president and group ex-

ecutive for sales and marketing from 1984 to 1987 at Apple Computer.

"Bill Campbell's expertise in building high-growth, technology-driven businesses will be critical to Go as we move from product development into market development on a worldwide basis," said Kaplan.

Of his departure from Claris, Campbell said, "During almost four years at Claris, we achieved our goals of creating a major new software company that has emerged as a market and technology leader. With

these accomplishments behind me, the opportunity to help Go Corp. realize its exciting potential was a very compelling and natural fit for me."

A successor to Campbell at Claris has not been named.

Reporting directly to Campbell in his new post at Go are Robert Carr, co-founder and vice president of software, Kevin Doren, co-founder and vice president of advanced technology, Paul Hammel, vice president of operations, Dan'l Lewin, vice president of sales and

LazerSet

DESKTOP MEDIA

- ★ CANON Full Colour Copier
- ★ TONER CARTRIDGE RECHARGE: All Major Brands of Personal Copiers & Laser Printers
- ★ SCANNING: Graphics/OCR
- ★ MAC RENTALS: MAC+, MAC II, MAC SE/30
- ★ Disc CONVERSIONS: IBM ↔ MAC
- ★ Self-Inking STAMPS
- ★ TYPESETTING

For Discount Coupon
VOICEFAX: 222-8444
Ext. 425 Desktop Media
Ext. 426 Toner Recharge



OPEN SATURDAY 11 AM - 6 PM

3496 Cambie Street • Tel. 876-5530 / Fax 876-8819

TARGA+

True-Color PC/Mac/Amiga based graphics systems with 16.7 Million simultaneous colors

Introducing the new TARGA+ from Truevision

Featuring:

- Windows 3.0 driver
- Real time video capture
- Runs all existing TARGA software
- NTSC, RGB, SVHS in and out
- Interlace & non-interlace modes
- Reduced prices

- VGA pass through and overlay
- Upgradable to TARGA 32 & 64
- On board digital keyer
- Overlay graphics on live video
- High and low resolution modes
- AT and PS/2 versions

Sales

Support

Training

First Image Group 112-1020 Mainland St. Vancouver, B.C. V6B 2T4 684-9586

VERSATILE Computer Products Ltd.

WHERE SUPPORT MEANS SOMETHING

COMPARE CLOSELY AND YOU'LL SEE THE DIFFERENCE

286-12
1 MB RAM
1.2MB FDD
40-MB HDD (28ms)
Hi-Res Monitor

COMTEX
\$995

386-SX
1 MB RAM
1.2MB FDD
40MB HDD (28 ms)
Hi-Res Monitor

COMTEX
\$1475

386-25
1 MB RAM
1.2 MB FDD
40-MB HDD (28ms)
Hi-Res Monitor

COMTEX
\$1790

Two-year parts & labor on ALL systems and hard drives

With Systems: MS DOS 3.3 or 4.01 \$75

Upgrades

12-inch Mono	\$105
14-inch Mono	\$135
CTX5432 VGA (640 x 480)	\$435
CTX5468 VGA (1024 x 768)	\$450
NEC 3D 14-inch	\$875
TVM 3A (1024 x 768)	\$515

Accessories

Complete Fax 9600B	\$625
Logitech Serial Mouse	\$90
Logitech Bus Mouse	\$110
Focus 2001 Keyboard	\$80
Gravis Joy Sticks	\$44
Smart label Printer	\$275
Sound Blaster	\$250

Printers

Roland 9101	\$225
Roland 2417	\$415
Roland 2465	\$555
Roland LP800 laser	\$1275
Roland LP1110 laser	\$1775
Fujitsu DL3400	\$545
Fujitsu DL1100	\$399
Epson LQ1050	\$798
HP/II	\$1380
HP/III	\$2295

Monitors

12-INCH MONO	\$105
14-inch mono	\$135
CTX5432 VGA (640 x 480)	\$435
CTX5468 VGA (1024 x 768)	\$450
NEC 3D 14-inch	\$875
TVM 3A (1024 x 768)	\$515

Hard Drives

Maxtor 40MB (28ms)	\$300
Maxtor 80MB (19ms)	\$525
Maxtor 200MB (15ms)	\$1950
Mitsubishi 40/64MB (25ms)	\$365
Rodime 200MB (19ms)	\$690
40 MB Installed	\$455

Modems

US Robotics 1200B Int	\$89
US Robotics 1200B Ext	\$120
US Robotics 2400B Int	\$155
US Robotics 2400B Ext	\$175
Cardinal 2400B Int	\$94
Cardinal 2400B Ext	\$130
Cardinal Fax/Modem	\$115

Laptops

Goldstar 386SX w/40MB	\$2615
-----------------------	--------

Printer Accessories

DL1100 color kit	\$60
------------------	------

DL3450 color kit \$125
80-Col printer stand \$12
132-Col printer stand \$15

Intel Co-Pros

80286-12	\$265
80386-SX/16	\$375
80386-SX/20	\$415
80387-25	\$599
80387-33	\$699

Tap Back-ups

Colorado DJ10 (40-120)	\$340
Colorado DJ20 (250)	\$425

\$50 Tune-up

- General cleaning
- Check and/or replace batteries
- Clean & check drives
- Virus check • Check installed boards
- Optimize components
- Prepare report

We are Novell certified.

ALL PRICES SUBJECT TO 7% GST

Software

Accpac Bedford	\$128
Accpac Easy	\$64
Clipper V. 5	\$568
Copy II PC	\$35
Corel Draw V.2	\$450
Crosstalk IV/XVI	\$140/\$126
dBase III V1.1	\$518
dBase IV V1.1	\$534
Desqview 2.2 / 386 V.3	\$108/\$178
Direct Access 5	\$75
Eight In One	\$45
F19 Stealth Fighter	\$57
Fast Back Plus	\$138
File Shuttle	\$90
First Publisher V3.0	\$128
Flight Simulator 4.0	\$41
Form Tool	\$75
Form Filler V.3	\$109
Foxbase Plus	\$255
Gofer	\$63
Grammatik IV	\$69
Harvard Graphics 2.3 (new)	\$338
Laplank III	\$118

Lotus 123 V 2.2/3.1	\$395/\$485
Lotus Agenda	\$351
Lotus Symphony	\$555
Mace Utilities Gold	\$89
Mace Utilities 5	\$109
Mavis Beacon Teaches Typing	\$45
Maximizer	\$166
Microsoft Quick Basic 4.5	\$78
Microsoft Quick C Compiler V2.5	\$78
Microsoft Learning DOS	\$43
Microsoft Excel	\$290
Microsoft Works 2.0	\$120
Microsoft Windows 3.0	\$98
Microsoft Project 4.0	\$364
Microsoft QuickBasic 4.5	\$76
Microsoft Word 5.0	\$197
Microsoft Word for Windows	\$290
Print Shop (Broderbund)	\$48
Norton Commander 3.0	\$117
Norton Backup V1.1	\$115
Norton Utilities Std 4.5/5.0	\$74/134
Paradox	\$695
PC Tools Deluxe V.6	\$95
PC Anywhere III V3.11	\$118

PerForm Designer & Filler	\$95
Printmaster Plus	\$56
Procomm Plus 1.1B	\$84
Professional Write 2.2	\$184
Professional Plan V1.0	\$78
Q & A Write 3.0	\$168
Quarterdeck QEMM 386 V5.0	\$88
Quarterdeck QEMM V5.1	\$80
Quattro Pro V2.0	\$378
Quicken	\$44
Rapidfile	\$179
Raven Script	\$135
Sidkick Plus	\$156
Sideways 3.2	\$55
Spirite II V1.1	\$97
Suzy	\$19
Tetris 2D	\$29
Turbo C V2.0	\$124
Typing Tutor IV Plus	\$39
Ventura 3.0 Windows	\$620
VP Planner Plus 3D	\$177
WordPerfect Office V3.0	\$118
WordPerfect 5.1	\$278
Xtree/Pro	\$35/\$80
And most other titles	CALL

Hours: Mon. - Fri. 8:30 a.m. - 6 p.m.
Thurs. 8:30 a.m. - 8 p.m.
Sat. 11 a.m. - 4 p.m.

Come see our expanded hardware/software display and take advantage of our Renovation Specials.

CALL OUR TALKING YELLOW-PAGES AD for more specials & expansion plans

Call 439-3311 and Press or Speak



Networking • Expert Servicing • Upgrades • Rentals • Trade-ins

We carry ONLY Authorized products:
IBM, NEC, AST, ALR, Epson, Roland, Datatrain,
NOVELL Comtex, Fujitsu, Express, Goldstar, Hewlett Rand and more.

The future is waiting at

VERSATILE

VANCOUVER TORONTO NEW YORK

1930 West Broadway, Vancouver V6J 1Z2
Phone 731-1930 • Fax 731-1960
Within B.C. 1-800-663-7463



SuperStore
Computers



Why Pay More
Elsewhere
for 100%
Same
Compu-Ware ?!

BUYER'S GUIDE

PC Magazine
Only
\$2.65

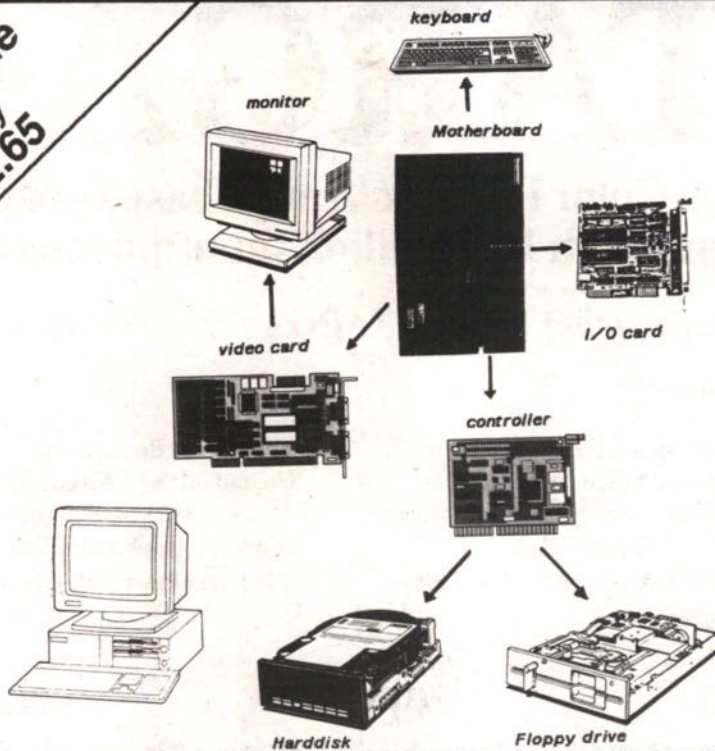

A typical micro-computer is not a "MAGIC BOX", just configured by some name brand pre-built devices, as:

Check the computer form inside out, part by part, as long as they're the same model/brand, **WHY SPEND MUCH MORE** for just a fancier name plate on the front panel of the computer case?!

Don't let the fancy name plate fool you, make your decision and **MINIMIZE YOUR COST FOR COMPUTERIZING!**

286/12 MHz AT System
\$799

386SX/16MHz System
\$1229

386SX/20MHz System
\$1349

386DX/25MHz System
\$1499

386DX/33MHz w/64K/25ns Cache
\$1899

*** ALL SYSTEMS INCLUDE:**

- 1 MB RAM (expandable)
- 1.2MB/5.25" TEAC Floppy Disk Drive
- 40 MB/28mS w/16-bit F/H Controller
- I/O Card with 1 Parallel/1 Serial/1 Game Port
- High-Resolution 12" Amber TTL Monitor
- Small Footprint Case/200W power supply
- Enhanced 101-Key Keyboard
- *Customized configuration on request
- *One Year Parts & Labor Warranty

UPGRADE OPTIONS

- RAM (Per Mega Byte) \$89.00
- Add Floppy Disk Drive \$79.00
(1.2M/5.25" or 1.44M/3.5")
- 80MB Hard disk \$285.00
- Mono VGA 12" & Card \$94.00
- Color VGA & Card \$319.00
(640x480 16-bit 256K)
- 1024 *768 16-bit 256K Card \$399.00
- 9-pin printer \$189.00

MS DOS
Ver 4.01
\$65.00

with System Purchase

LAPTOPS

Mitek 386SX-16MHz

- 40MB
 - VGA Backlit
 - 2 Hr. Battery
- \$3,499⁰⁰**

Laplus A-6200H

- 286
 - 40MB, EGA
- \$2,799⁰⁰**

AND MITSUBISHI, TOSHIBA

(PRICES SUBJECT TO CHANGE WITHOUT NOTICE)

MOTHERBOARD

286-12	\$125
386SX-16	\$455
386SX-20	\$575
386-25	\$765

MODEM/MICE

2400 int	\$79
MS Mouse	\$129
Mouse Pad	\$5.25

FLOPPY DRIVES

1.2/5.25" TEAC	\$85
1.44/3.5" TEAC	\$79
360K/5.15"	\$79
720K/3.5"	\$75

I/O CARDS

14" 640 x 480	\$329
1024 x 768/28	\$419

PRINTERS

Seikosha 9 pin	\$189
Roland 9101	\$219
Citizen 200 gx	\$249
Fujitsu 3400	\$479

MATH CO-PROCESSORS

80387SX-16	\$409
80387-20	\$519
80387-25	\$569
80387-33	\$659

HARD DISKS

30MB/XT ctrl	\$349
40MB/28ms	\$289
MR535	\$329
80MB/19ms	\$579
100MB/19ms	\$649
200MB/19ms	\$1099

I/O CARDS

AT I/O Card	\$19
Serial Port Chip	\$12

VIDEO CARDS

Mono	\$15
VGA 16 bit 256K	\$89
ATI VGA Wonder	\$189
Tricom 1MB	\$185

MISCELLANEOUS

Printer Cable	\$7.50
Keyboard ext.	\$5.50
Monitor ext.	\$5.50
VGA ext. cord	\$9.50
Power bar	\$12.50
Printer Stand	\$9.50
Computer Desk	\$99

MONITORS

12" TTL Amber	\$89
14" TTL b/w	\$119
12" Mono VGA	\$105
14" Mono VGA	\$135

DISKETTES

Sony 1.2MB	\$13.99
Sony 1.44MB	\$26.99
KAO 1.2MB	\$11.99
KAO 1.44 MB	\$19.99

CHECK OUT OUR UPDATED PRICES!

Super Special!

All Books & Magazines
15% OFF

**#3, 111 West Broadway,
Vancouver, B.C. V5Y 1P4**

TEL. (604) 876-6363 FAX: (604) 876-6361

marketing, and John Russell, vice president and chief financial officer. Contact: Go Corp, 415/345-7400; Claris, 408/987-7202.

Claris Software To Bundle Charting Apps

MOUNTAIN VIEW, CALIFORNIA, JAN 2 (NB)—The software subsidiary of Apple Computer is bundling the Cheshire business charting program with copies of MacWrite II and MacDraw II. The promotion will continue through March 31, Claris officials said.

Cheshire carries a retail price of \$125, and is published by Abbott Systems, Pleasantville, New York. The utility lets users create and manipulate charts within a word processing or drawing applications.

Claris said only selected authorized dealers are participating in the promotion. Participating dealers can be found by calling Claris at 408-727-8227.

Abbott Systems is headed by Ken Abbott, former president of Manhattan Graphics, the company that wrote Ready, Set, Go, now published by Letraset. The company also sells CanOpener, a utility that lets users open files created by applications they don't own. Contact: Claris, 408-987-7202; Abbott Systems, 800-552-9157.

NoRad Intros Radiation Shield For Mac Classic

SANTA MONICA, CALIFORNIA, JAN 7 (NB)—NoRad Corporation has introduced a NoRad Shield for the Macintosh Classic. The Model 2524-P is platinum with a flexible frame to match the color and bezel shape of the Mac Classic.

NoRad Shields have been tested independently and meet US Military Specifications. Of several products claiming to do the same thing, the company's shields have been certified as the most effective product blocking video display terminal non-ionizing electromagnetic radiation. The NoRad Shield is said to provide broad-spectrum EMR attenuation including better than 99.9 percent of virtually the entire E-field (electric), including ELF and VLF, and better than 50 percent of the H-field (magnetic) above 30 kiloHertz.

In making the announcement, Bruce Sperka, NoRad director of marketing noted that Mac users represent a strong customer base for his company. The immediate popularity of the Mac Classic led NoRad to develop this shield as quickly as possible, he said.

Users can install this shield by means of Velcro tabs with which it can be attached to the monitor bezel. Suggested retail price for the Model 2524-P is \$129. The NoRad SuperShield for 16-inch monitors is priced at \$249. Both are available immediately. Contact: NoRad, 213-395-0800.

Apple Earns \$150.5 Million In First Quarter

CUPERTINO, CALIFORNIA, JAN 18 (NB) — Apple Computer says net revenues rose 12 percent for its first fiscal quarter ended Dec. 28, 1990 compared to the same quarter last year. Earnings are up 33 percent from the first quarter in the prior year.

John Sculley, chairman and chief executive officer, attributes the figures to strong product demand. "The new prod-

ucts we introduced this past quarter — the Macintosh Classic, Macintosh IIsx, and the Macintosh LC — have been extremely well-received." He says shipments of Macintosh computers are up 50 percent during the first fiscal quarter from the year-ago level.

Net revenues for the quarter were \$1.676 billion, compared to \$1.493 billion in the year-ago period. International revenues accounted for 45 percent of total revenues during the quarter, compared to 36 percent in the first quarter of

fiscal 1990. A weak U.S. dollar gave Apple greater opportunity to offer its new products at attractive price points in many of its international markets, the company said. Contact: Apple, 408/974-2202.

Canadian News

SHL Systemhouse

Chairman Steps Down

OTTAWA, ONTARIO, JAN 11 (NB)—Roderick Bryden has resigned as chair-

man and chief executive of SHL Systemhouse, at the request of the company's board of directors. A founder of the systems integration firm, Bryden will leave May 31, or sooner if a replacement is found before then.

Donald Paterson, a spokesman for the Systemhouse board of directors, said the board believed Bryden had to go to restore investor confidence in the company. A major factor, he said, was the financial troubles of Kinburn Capital, a holding company headed by Bryden

NOTICE:

To all former customers of
Omni Data, one call to
DOPPLER COMPUTERS
will give you immediate
delivery of all your computer
supplies & accessories
We will match all volume prices.



<h3>Data Cartridges</h3>  <p style="color: red; font-size: 1.2em;">SPECIAL 20% Off</p> <p>In Stock all the time!</p>	<h3>Diskettes</h3>  <p style="color: red; font-size: 1.2em;">SPECIAL 20% Off</p> <p>Other Brands Available</p>	<h3>Ribbons</h3>  <p style="color: red; font-size: 1.2em;">SPECIAL 20% Off</p> <p>No One beats our Prices!</p>		
<h3>Laser Toner</h3>  <p>Compare our prices...</p> <p>Genuine Toner Cartridges For HP, Canon, Apple QMS and more.</p> <p>Volume Prices! 119⁹⁹</p> <p>Call for Panasonic, NEC and more. Open every day!</p>	<h3>Vertical CPU Stand</h3>  <p>A Vertical CPU Stand will you computer off you desk and give you valuable space 100% safe- You'll love it.</p> <p>Strong plastic 29⁹⁹ Heavy duty metal 39⁹⁹</p> <p>Use your account</p>	<h3>Keyboard Draw</h3>  <p>Completes total desk organization, pull your keyboard out on action gliders at just the right height.</p> <p>Keyboard Drawer 59⁹⁹ Above Desk Drawer 79⁹⁹</p> <p>30 Day money back</p>	<h3>Surge Protection</h3>  <p>Tycor is the most cost effective way to add years of trouble free life to your computer. Reduces errors.</p> <p>Tycor EMI/RFI Protector 239⁹⁹ 350w Battery Backup 659⁹⁹</p> <p><small>NOTE: When purchased with computer system gives two year warranty</small></p>	<h3>Copy Holder</h3>  <p>Copy holders eliminate neck, shoulder, back and eye strain. Put the copy where you want it. Clear desk</p> <p>Universal clamp arm 35⁹⁹ Desktop with base 29⁹⁹</p> <p>Huge book selection</p>
<h3>Power Bars</h3>  <p>Expansion power bar 19⁹⁹ Surge Protection Bar 27⁹⁹ Surge EMI/RFI Surge Clamp Bar 59⁹⁹</p> <p>\$1,000,000 Inventory</p>	<h3>Cables</h3>  <p>15" Printer Cable 19⁹⁹ Keyboard Extension 19⁹⁹ Monitor Extension 19⁹⁹ VGA Monitor Extension 24⁹⁹ Modem Cable 19⁹⁹</p> <p>In stock all the time</p>	<h3>Tool Kit</h3>  <p>Contains 11 of the most common tools needed to maintain and enhance your computer, incl. chip tools</p> <p>11 Piece PC Tool Kit 29⁹⁹</p> <p>7 Years of service</p>	<h3>Bernoulli Cart</h3>  <p>Quality Brand Name Bernoulli Cartridges in stock at discount prices.</p> <p>8" 20 Meg Cart 158⁹⁹ 5" 20 Meg Tri Pac 299⁹⁹ 5" 44 Meg Tri Pac 399⁹⁹</p>	<h3>So Much More...</h3> <p>Software Computers Laptops Training Printers Support</p>

DOPPLER Computer Centre

875-0261

101 WEST 5TH AVE
cross street Manitoba
7 DAYS A WEEK

which holds a stake in Systemhouse.

Bryden cofounded Systemhouse with Jack Davies in 1974, supplying most of the capital to start what was then a new concept: a company that not only did custom programming but provided finished systems to clients at a guaranteed price. The company was successful through the late 1970s, but needed capital to finance its expansion. That led to a stock offering in 1980. Then Systemhouse went through a tough period, marked by losses, staff cutbacks, and widespread doubts about its accounting procedures. Davies left the company in 1983.

Meanwhile, Bryden had established Kinburn, which was the majority share-

holder in Systemhouse. Kinburn also had other investments, including a stake in a cardboard recycling operation whose profits helped pull Systemhouse through the tough times of the early 1980s.

Today, the tables are turned. Systemhouse had a poor 1990 but rebounded in the first quarter of this year, and Paterson says the company's prospects are good for the rest of the year, although its board believes the stock is undervalued. Kinburn is in trouble. Unable to repay loans, the company has lost control of its stakes in Systemhouse and in Computer Innovations Distribution, which controls Canada's Computerland franchises.

"No matter how you want to separate Kinburn from Systemhouse, and they are separate," Paterson said, "the commonality of Rod being the chief executive of both, I think, has had a negative impression."

Systemhouse will keep Bryden on for two years as a consultant to the chief executive, paying him a fee for that period equivalent to one year's salary, bonus, and benefits. Paterson said this arrangement is mainly a method of spreading out payment of Bryden's severance benefits for tax purposes, although he may be called upon to provide occasional advice to the company. In a prepared statement, Bryden said he will keep

his 325,000 shares in the company and buy 125,000 more with financing help from Systemhouse. Contact: SHL Systemhouse, 613-238-6648.

IBM Canada Cuts Prices Due To GST

MARKHAM, ONTARIO, JAN 15 (NB)—Responding to a change in the federal sales tax system, IBM Canada has cut computer hardware prices five percent. Prices for most supplies were cut six percent, and some paper items are 11.9 percent cheaper.

The reason for the change was the replacement of the old Federal Sales Tax (FST) by the Goods and Services Tax (GST) January 1. The FST applied to a limited range of goods but at high rates—13.5 percent on computer hardware. The GST is a seven-percent tax on almost everything.

The amount of FST actually included in the price of goods was affected by the amount of manufacturing done in Canada as opposed to outside the country, explained Martha Terdik, a spokeswoman for IBM Canada. Thus elimination of the tax has not led to price reductions by the amount of the tax.

Prices of all hardware except IBM 468X Point-of-Sale products have been cut five percent, IBM said. Prices for software, maintenance service, and rental, none of which were affected by FST, are unchanged.

However, the new prices do not include GST, which unlike FST will be shown separately rather than buried in the prices of goods. Most businesses can claim an input tax credit for the GST they pay, so the net cost will be lower. For anyone not eligible for the credit, however, the products will be slightly more expensive. Contact: IBM Canada, 416-474-3900.

Mitel, Bosch Mum On Acquisition Rumor

OTTAWA, ONTARIO, JAN 8 (NB)—Neither company will confirm a rumor that Robert Bosch GmbH, which last fall backed out of plans to acquire cellular telephone maker Novatel, will buy into another Canadian telecommunications company, Mitel. It is public knowledge that British Telecom, which owns 51 percent of Mitel, wants to sell.

James Straus, a spokesman for Bosch in the United States, told Newsbytes he knew nothing of plans for the German electronics firm to acquire Mitel, and had no further comment on the rumor. Bonnie Perrigard, a spokeswoman for Mitel in Ottawa, said only that the company could not confirm the rumors.

British Telecom announced a year ago that it wanted to sell its majority interest in Mitel, purchased in 1986. Assorted minority shareholders and pension funds own the other 49 percent of the company.

Last summer, Bosch was understood to be ready to buy half of Novatel, a manufacturer of cellular telephones, from Alberta Government Telephones, since renamed Telus Corp., after the provincial government sold shares to the private sector. In November, Bosch pulled out of that deal, saying it had determined the purchase would not meet its objectives. At the end of December, Telus exercised an option—put in place to reassure prospective purchasers of Telus shares—to sell Novatel to the pro-

MEGATRONICS

We specialize in repairs, trade-ins & upgrades

- We offer:**
1. Educational & volume discounts
 2. On-site servicing
 3. Pre-screened components
 4. Full service department with low rates
 5. FREE phone support with every purchase

We do mail orders!



MEGA \$PECIALS

FEATURE SYSTEM!

386-25MHz Fujikama Motherboard
 AMI BIOS, C&T Chipset
 Math Co-socket for 387-25/ 287!
 1MB (80ns) RAM exp 8MB on board
 Maxtor 40MB Voice Coil 28ms 32K Cache
 AT I/O w/1 serial, 1 parallel, 1 game
 101 Enhanced Tactile Keyboard
 Super VGA Color (1024 x 768) .28 dot pitch
 w/512K SVGA Card
 Baby AT Desktop Case
 3 button mouse with pad
 * Many options available

\$1991

SUPER VGA BUNDLE!

AOC SVGA 14" Color Monitor
 1024 x 768 x 256 Colors Resolution, .28 dot pitch
 BUNDLED with Trident 1MB SVGA Card

\$549

MAXTOR 80MB HARD DRIVE BUNDLE!

Maxtor 80MB 19ms 1" height IDE w/32K Cache
 w/16 bit Floppy/Hard IDE Controller

\$495

CASH & CARRY PRICES

MEGA LIST

ALL ITEMS SUBJECT TO AVAILABILITY

Teac Floppy Drives

360K 5.25" \$85
 1.2MB 5.25" \$95
 720K 3.5" \$85
 1.44MB 3.5" \$95
 Prices include bracket!

Printers

Fujitsu DL1100 24 pin \$395
 240cps draft 60 cps LQ
 Color Option Kit \$65
 Raven 9101 - 9 pin
 192 cps NLQ \$240
 Prices include cable!

Video Cards

Trident 1MB SVGA \$175
 Ahead 256K SVGA \$125
 with 512K \$155

Soundblaster

Soundblaster Music Card \$185
 MIDI Kit \$145
 CIMS ((Stereo))) Chips \$45

Hard Drives (Bare)

Maxtor 40MB Voice Coil
 28ms IDE \$295

Mitsubishi 40/65MB

28ms MFM/RLL \$335
 Maxtor 80MB
 19ms IDE \$495

Rodime 110MB

18ms IDE \$595
 Rodime 210MB
 18ms IDE \$1155

Miscellaneous

720K to 1.44MB Disk Notcher \$45
 Logitech 3 button Serial Mouse \$75

BTC 3 button Serial Mouse

..... \$29
 Zoltrix Send/Receive
 Fax Modem \$189

Main Boards (OK)

286 - 12MHz (8 slots) \$155
 286 - 16MHz \$195
 386SX - 16MHz \$465
 386 - 25MHz \$695
 386 - 25MHz cache \$825
 386 - 33MHz cache \$985
 486 - 25MHz cache \$2095



MEGATRONICS

3243 Main St. at 16th, Vancouver, B.C. V5V 3M6
 Tel: (604) 876-8855 Fax: (604) 876-8779

Store Hours
 Mon. - Sat. 10:00am - 7:00pm
 Sunday ... 12:00pm - 5:00pm
 Open Sundays for your
 computer shopping needs

vincial government.

Mitel manufactures telephone switching equipment. Contact: Mitel, 613-592-2122; Bosch, 708-865-5200.

Alberta Govt. To Buy Cellular Phone Company

EDMONTON, ALBERTA, JAN 4 (NB)—Telus, the telecommunications company the provincial government of Alberta recently sold to the public, will sell its money-losing cellular telephone manufacturing subsidiary back to the province. Telus has exercised an option to sell Novatel following the collapse of a deal to sell a half interest in the company to the German electronics firm Robert Bosch.

The province will pay Telus C\$159.4 million for Novatel. Betty McLennan, manager of media relations at Telus, said that figure represents Telus' C\$139-million investment in Novatel, plus a C\$50-million premium the company would have made on the Bosch deal had it gone through, less C\$14.6 million in adjustments and C\$15 million that has been made conditional on Novatel's performance over the next two years.

Telus will manage the maker of cellular telephone equipment for the next two years. In addition to payment for its services, Telus will get 10 percent of Novatel's net earnings during that period, if the company turns a profit. Neither MacLennan nor James McDonald, deputy chairman and managing director of Novatel, would comment on Novatel's financial prospects.

Last fall, after concluding Novatel's forecast of a C\$16.9-million profit could not be validated, the Alberta government guaranteed it would buy Novatel from Telus if no other deal was closed. Press reports have referred to a projected C\$4-million loss for the second half of 1990, but McDonald told Newsbytes that figure came neither from Novatel nor from Telus. At the end of November, Bosch pulled out of its planned purchase of 50 percent of Novatel, saying it had decided the deal would not meet its objectives.

Commenting on reports the Alberta government will try to sell Novatel to private interests, McDonald said informal discussions are continuing with several parties interested in buying in. Novatel continues to believe it needs a private-sector backer, he said. Contact: Telus, 403-493-4780; Novatel, 403-295-4500.

Orchard Adds To Financial Software

VANCOUVER, BRITISH COLUMBIA, JAN 17 (NB) —Orchard Software, based here, has added two packages to its financial software line-up. The new Professional Invoicing and Inventory/Invoicing packages support Canada's new Goods and Services Tax, said Lee Brebber, Orchard's marketing manager.

Because the software was developed in the United Kingdom, Brebber told Newsbytes, support for a value-added tax was already there. However, Orchard has extended it to support as many as nine GST rates and nine provincial sales tax rates. "Quite a few of the companies we deal with are multi-provincial," he said.

Orchard's Professional Invoicing is a free-flow invoice module that works with the company's Accounts Receivable software. It sells for C\$395.

The Inventory/Invoicing package combines the functions of the Professional Invoicing software with inventory management. The software allows up to 90 user-defined fields as well as standard information, and supports multi-warehousing, defined inventory categories, and pricing details. It sells for C\$495, Brebber said.

Contact: Orchard Software, 604-588-7768.

Easel Opens Offices In Canada

WOBURN, MASSACHUSETTS, JAN

17 (NB) — Easel, the maker of graphic application software development tools, is opening new offices in Toronto and Atlanta.

A new Eastern Canada office — Easel's first direct presence in Canada — will be located in Toronto, Ontario.

Easel's new South Central regional office in Atlanta will cover Alabama, Arkansas, Florida, Georgia, Louisiana, Mississippi, South Carolina, and Texas.

Both offices will be operational by March, 1991, Easel said. The company currently has offices in the New York, Chicago, and Los Angeles areas. Contact: Easel, 617-938-8440.

Software Firms Join Toronto Stock Index

TORONTO, ONTARIO, JAN 8 (NB)—In the annual revision of its most important stock indicator, the Toronto Stock Exchange has added three computer software companies to the list of 300 active stocks making up the TSE 300 Composite Index. The newcomers are Cognos, an Ottawa maker of applications development software; Corel, producer of the Corel Draw graphics software; and Intera Information Technologies, a Calgary, Alberta firm that develops software for petroleum and resource com-



Get the full force of DataTrain on track for you.

When you get on track with DataTrain, you get more than built-in quality at a very attractive price.

You get the full force of an entire product family that will satisfy the needs of demanding, yet budget-conscious users now, and in the future.

Our fully compatible PC family can be economically upgraded to meet the everchanging needs of a growing business. From the convenient laptop portability of the 12 Mhz DPC-2812 with VGA and 1MB RAM, to the powerful DPC-3333, 33 Mhz and 4 MB of RAM, to the DNS-200 Network compatible workstation, there is a DataTrain product to suit the needs of virtually any type of business.

Your business will appreciate the quality and reliability of DataTrain products and the security of

knowing each model is backed by a no-nonsense two year parts and service warranty from Roland DG Canada.

Choice. Quality. Reliability. Exceptional warranty plus the integrity and security of Roland DG, Canada's most respected name in the micro-computer industry. The powerful forces of the DataTrain family will get your business on track for you...today.

DataTrain

Roland DIGITAL GROUP

The DataTrain Family of Quality Computers

DPC-2812 Laptop, 12 Mhz, 80286, 1MB RAM, LCD Display, VGA
 DPC-1000 PC, 8088, 10 Mhz, 768 KB RAM, DOS*
 DPC-2200 12 Mhz, 80286 1MB RAM, VGA Video*
 DPC-2112 12 Mhz, 80286, 640KB RAM, CGA*
 DPC-2112 12 Mhz, 80286 1MB RAM, VGA*
 DPC-3016 16 Mhz, 80386SX, 2MB RAM, DOS*
 DPC-3325, 25 Mhz, 80386, 4MB RAM, VGA Video*
 DPC-3333, 33 Mhz, 80386, 4MB RAM, 64KB fast cache memory*
 DNS-200 Network Station, 12 Mhz 80286, 640 KB DRAM*
 DNS-300 Network Station, 16 Mhz 80386SX, 1 MB DRAM*

*These systems are Novell® Network compatible.

For more information on DataTrain products and warranty, the DataTrain Authorized Dealer Program, or other Roland DG products, call:

Vancouver
(604) 273-4453

Toronto
(416) 624-5944

Montreal
(514) 332-6371

Ottawa
(613) 723-0724

Calgary
(403) 277-1811

Brands and product names identified by ® are trademarks or registered trademarks of their respective companies.

New & Improved Version 5.01

"Thanks —again
HELP Payroll,
for even more
flexibility without
complexity."



HELP Canadian Payroll

has new & improved flexibility without added complexity.

HELP Canadian Payroll

remains one of Canada's best selling payroll packages with:

- an extremely simple & user friendly interface
- integration to most major General Ledger packages
- 10 user defined earnings & 10 user defined deductions
- ability to print not only your employee cheques but your Revenue Canada remittance cheques, T4's and ROE's as well
- no limit to the number of employees or companies you process

HELP Canadian Payroll has been serving small businesses and accounting firms like your own for over 5 years and has over 1,000 installed users. So you can buy with the confidence that HELP will be there if you need it. Still ONLY \$349.95. Talk to your friends, they are probably already using HELP Canadian Payroll.

For more information call HELP Software at (604) 435-6268

5487 Kingsway, Burnaby, B.C. V5H 2G1

Dealer inquiries are welcomed.

NEW FLEXIBILITY — SAME PRICE — ONLY \$349.95

At Campus Computers We Did Our Homework!!

**PANASONIC
1180 Printer**

\$188

**PANASONIC
1124 Printer**

\$368

FAX MODEM

9600 Send/Receive
2400 Modem
Incl. Software

\$178

**SAMTRON
SC-441 VGA Color
Monitor 640 X 480,
.41 Dot Pitch**

\$298

**AAMAZING
CM-8484E II
Super VGA Monitor
1024 X 768, .28 Dot Pitch**

\$418

**8-BIT SUPER
VGA CARD**

256K, 800 x 600

\$63

**CAMPUS
COMPUTERS**

2162 Western Parkway Vancouver, B.C. V6T 1V6
HOURS: 9:30 am - 5:30 pm Mon. - Fri., 10:00 am - 4:00 pm Sat.

TEL. 228-8080 FAX 228-8338

**SEE OUR OTHER AD
ON PAGE #62**

panies.

The additions were part of a revamping that saw 18 companies cut from the index. None of those deleted were in the computer industry, although BCE Development, a subsidiary of BCE, which owns Northern Telecom, Bell Canada, and Bell-Northern Research, was one of those cut. Northern Telecom remains the largest high-technology company on the TSE 300. The companies dropped also included Campeau Corp., much in the news recently due to the heavy financial losses of department stores it owns in the United States.

The list of 18 companies added to the index also included Rogers Communications, which is part owner of Unitel Communications, the company whose application to provide competitive long-distance telephone service across Canada is now before federal regulators. Rogers also owns Cantel, a national cellular telephone service provider.

Marija Finney, manager of the index section at the TSE, told Newsbytes stocks are selected for the index by a complex process involving the stock's value, trading volumes, and the number of shares actively traded outside of large control blocks. Companies must also be incorporated in Canada and have traded on the exchange for a year to be included, she said.

Finney said about 14 high-technology companies are currently included in the TSE 300 index. The exchange also maintains a specialized high-technology index. Finney said she could not comment on any trends indicated by the latest changes in the makeup of the index. Contact: Toronto Stock Exchange, 416-947-4226.

IBM Alumnus Is New Boss At Microsoft Canada

MISSISSAUGA, ONTARIO, JAN 17 (NB) — Microsoft Canada has a new general manager — again. Frank Clegg, formerly a senior marketing executive at IBM Canada, is taking over from Patty Stonesifer, who after only nine months in the job is returning to the United States to accept a promotion on which the company has released no further details.

A spokeswoman for Microsoft told Newsbytes the change was a return to Microsoft's policy of filling senior management posts with natives of the countries where subsidiaries are based. Stonesifer, an American, was brought in from Microsoft Press last year to replace Malcolm MacTaggart. Clegg is Canadian, a graduate of the University of Waterloo in Waterloo, Ontario, and has worked for IBM Canada for 14 years. His latest job was as branch manager, manufacturing and process, at IBM Canada in Toronto. Contact: Microsoft Canada, 416-568-0434; Creative Marketing Network for Microsoft, 416-539-0694.

Waterloo Microsystems Becomes Hayes Canada

WATERLOO, ONTARIO, JAN 8 (NB)—Hayes Microcomputer Products has hired all staff at the former headquarters of Waterloo Microsystems here and changed the name on the office to Hayes Canada. Hayes acquired the network operating system developer late last year.

Sharon O'Brien, a spokeswoman for Hayes, told Newsbytes that former em-

ployees at the Waterloo office "now work for Hayes." The acquisition brought Hayes considerable technical expertise, she said, as well as a much-needed boost in the modem maker's Canadian presence. Contact: Hayes, 404-449-8791.

Wicat To Provide Computer-Based Training To Air Canada

OREM, UTAH, JAN 17 (NB) — Wicat Systems has announced that its wholly owned subsidiary, Wicat Canada, has signed a \$741,000 agreement with Air Canada to provide computer-based training (CBT) for flight and maintenance crews of Boeing and Airbus aircraft.

The hardware and software will be installed at Air Canada's main training facilities in Montreal and Toronto, with additional installations in Vancouver, and Winnipeg. Each installation will consist of a Wicat 386-based PC running software which integrates animation, interactive video disc and graphics software. The larger installations in Montreal and Toronto will have up to 30 WITS 4000 student workstations on a Novell network. The program replaces the traditional classroom lecture and slide presentation and will be used to provide transition training for qualified pilots and mechanics of the new aircraft.

Wicat spokesperson Michael Plante told Newsbytes that this is the first time that software has integrated courseware from different airframe manufacturers on the same platform. Plante says Wicat has integrated Wicat courseware, outside vendors and the airframe manufacturers themselves, all controlled by a Wicat management system.

A stand-alone station will be set up in London, and Air Canada will have a stand-alone travel unit for remote training at other sites. Wicat officials say Air Canada plans to provide computer-based training for all flight and maintenance personnel for its new fleet of Boeing and Airbus aircraft. Contact: 801-224-6400.

Mitel President Resigns

OTTAWA, ONTARIO, JAN 11 (NB)—John Jarvis has resigned as president and chief executive of Mitel. Anthony Griffiths, chairman of the telecommunications equipment maker, will assume both titles.

A brief statement from Mitel said Jarvis has resigned "to pursue other business interests." Jarvis came to Mitel in July, 1987, having been group chief executive for the computers and telecommunications group of PA, a management and technology consulting firm, in Britain.

A year earlier, British Telecom had bought 51 percent of Mitel. At the beginning of 1990, the telephone utility announced it wanted to sell that stake, but so far no buyer has been found. Recent rumors had Robert Bosch, a German electronics firm, ready to bid on the company, but neither company would confirm this.

Mitel moved back into the black after four years of losses soon after Jarvis' arrival. However, in the six months ended September 28, 1990, the company reported a loss of C\$7.1 million. Company spokeswoman Bonnie Perrigard attributed those losses to increased costs resulting from a major marketing push.

Griffiths has been with Mitel since 1985. Contact: Mitel, 613-592-2122.

DTPublishing

Lasermaster Completes Sale Of \$10 Million Debentures

MINNEAPOLIS, MINNESOTA, JAN 2 (NB)—Lasermaster Technologies, Inc. has confirmed the sale of \$10 million of the company's 10 percent convertible subordinated debentures, the maximum allowed under its registered offering.

Mel Masters, Lasermaster CEO, says the offering has been a success in meet-

ing immediate inventory purchase requirements and in providing a working capital reserve which management considers prudent, given international political uncertainty at this time.

Lasermaster designs, manufactures and markets laser printer and display systems and subsystems for high-quality electronic printing and desktop publishing applications. The product line includes high-performance printer controllers, plain-paper desktop typesetters and integrated publishing systems using the company's proprietary TurboRes resolution enhancement technology.

Contact: Lasermaster, 612-941-8687.

General News

Soviet Free Press Era Ending?

MOSCOW, U.S.S.R., JAN 17 (NB) — U.S.S.R. President Gorbachev has asked parliament to temporarily suspend the press law introduced last year which allows independent news services to operate and desktop publishing to be performed. After some discussion, deputies naysayed.

The President wanted to introduce censorship on Baltic events coverage in the free press. After Parliament denied his request, Mr. Gorbachev proposed that the Supreme Soviet enforce control on newspapers or at least force all of them, "from Pravda to Kommersant to Kurant" to show all available opinions not just one. The peoples' deputies agreed to this request.

Censorship activities have already begun. Interfax information service has suspended its flow of information to subscribers. Moscow News' Russian lan-

Altima Portables: The World's Best



When you want the uncompromising power and flexibility of a desktop, but need the convenience of a portable, there is only one choice. Altima.

Altima portables are the **only** portables with a **detachable**, 101-key keyboard (including a numeric keypad). And standard features that are expensive options on other portables. Like a built-in, **2400 baud modem**. A **PC expansion slot**. A **40 MB hard disk**. Industry standard memory expansion slots. And a mouse too. Add to this a stunning **paper white LCD display** (you've got to see it to believe it) and a price tag hundreds (even thousands) of dollars less than the competition and you'll see why Altima portables are simply, the best you can buy. Period.

Now there's a notebook computer that makes all others seem like scratch pads.

Introducing Altima NSX, the notebook that combines 80386SX technology, VGA display, built-in 2400 baud modem with FAX capability, 2MB RAM expandable to 8MB, 20MB hard drive/1.44MB floppy and a hard disk drive... all neatly wrapped in an extremely lightweight package.

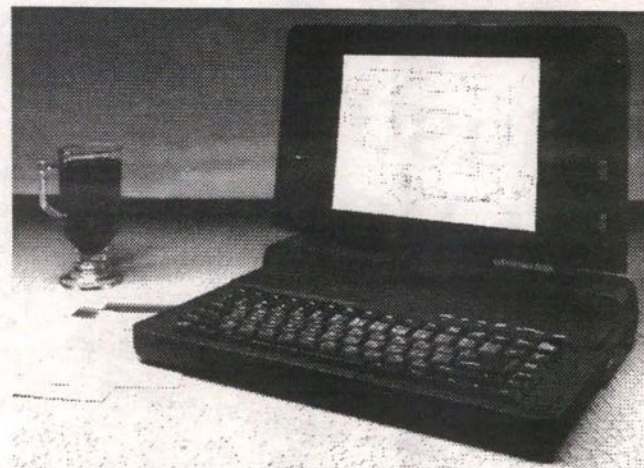

Westcoast Computers - "The Specialists"

1915 Lonsdale, North Vancouver, B.C. 986-7680

Altima NSX



PHASE 1 SYSTEMS CORPORATION



TOP OF THE LINE USA MADE SYSTEMS

286-12mhz	\$Call	386DX-25mhz w/64k Cache .	\$Call
286-16mhz	\$Call	386DX-33mhz	\$Call
386SX-16mhz	\$Call	386DX-33mhz w/64k Cache .	\$Call
386SX-20mhz	\$Call	486-25mhz w/128k Cache .	\$2499
386DX-25mhz	\$Call	486-33mhz w/128k Cache .	\$3399

NEW!!-> 486-40mhz w/128k Cache ..\$4499

Systems Come with:

- 1 Meg Ram • 1.2 Meg Floppy
- Static Guard Deluxe DeskTop Case
- 200 W CSA Approved Pwr Supply
- 101 Enhanced Soft Touch Keyboard
- Multi I/O Card • 1S/1P/1G Port

All 486 System Come standard with 19" LED Tower Case!

Case Upgrades:

- Slim Line Case\$49
- Mini Tower\$59
- 19" LED Tower\$69
- FULL LED Tower\$79

Warranty & Service

- 2 Years Parts & Labour
- 2.5 Year On Motherboards
- 4 Months On-Site (Covered by Xerox)
- 1-800 Support & Help Line

SUPER SPECIALS & NEW PRODUCT LINES

ALL VOICE COIL Hard Drives

Itama 45 Meg w/64k Cache	\$ 295
Mitsubishi 65 Meg RLL	\$ 349
Rodime 110 Meg IDE w/64k	\$ 649
MicroScience 110 Meg IDE	\$ 695
Maxtor 80 Meg IDE	\$ 549
Maxtor 200 Meg IDE	\$1095
Maxtor 339 Meg ESDI	\$1799
IDE 16 Bit HD/FD Controller	\$ 39
RLL 16 Bit 1:1 HD/FD Controller ..	\$ 149
Ultraator 20mhz ESDI Controller .	\$ 239

DAEWOO LAPTOP

- 1 Meg RAM
- New LCD Screen **\$3095**
- 640 x 480 16 Gray
- 40 Meg 19 ms Hard Drive
- 1.44 Floppy Drive
- DOS 3.3 & Manuals
- 1S/1P/1G/Mouse Port
- Free Deluxe Case!

RAM Modules

SIMMs	
1 Meg 80ns RAM Module.....	\$79
Upgrade Now	
4 Meg RAM Module.....	\$ 499
8 Meg RAM Module.....	\$2299

Custom Software

- Abacus Account Software
- Point Of Sale Systems
- Video Store Systems
- Network Solutions
- Bar Code Readers
- ID Card Systems
-GST READY!!.....

Fax Boards/Modems

Zoltrix 9600	
Send/Recv & 2400 Modem	\$199
Smart One 9600	
Send/Recv & 2400 Modem	\$239
NEW! US Robotics	
14.4 w/ V.42 38,400bps	\$699
2400 BPS Internal Modems 89	

Monitors

Loop 1024x768 .28 Pitch	\$ 459
Morse 1024x768 .28 Pitch	\$ 479
Samtron P/White VGA & Oak Card\$ 295	
Selko 1440 Interlaced	\$ 699
Selko 1450 Non-Interlaced	\$ 849
VGA Cards	
Paradise OEM 1024x768 w/256k\$ 149	
ACER OEM 1024x768 w/256k .	\$ 149
ATI OEM 1024x768 w/256k	\$ 239
Trident 1 Meg Super VGA	\$ 179
Teeng Labs 4000 Super VGA ..	\$ 215
Expand to 512k	\$ 29

VISA 2% Charge on VISA Orders **Please Call for Price Updates & Surprise Specials!** CANTEL APPROVED AGENT

Tel: 291-1558 Fax: 298-5126 Cell: 644-2152

guage edition was shut down due to its very pro-Baltic position. The TASS government news service has fired a number of reporters in Leningrad due to "bad [Baltic crisis] information misinterpretation." They will be replaced by retired Communist party officials, Radio Russia reports.

Stories Carried By Other Media This Month

WASHINGTON, D.C., JAN 11 (NB)—Roundup is a brief look at some computer stories carried in other publications this past month.

Sunday's *New York Times* (NYT) carried

an article on the current or coming production of monitors with very low or extremely low electromagnetic radiation emission levels. The companies involved state that this is not for health or safety concerns but rather a reflection of market forces.

This same NYT edition reported that Insite Peripherals, San Jose, Calif., has developed and is close to shipping a prototype "floptical" disk drive which reads and writes data to both super floppies and conventional disks; other manufacturers striving to produce flopticals are Brier Technology, also in San Jose, and Japan's NEC and Toshiba. (Newsbytes note: The October issue

of *Byte* contained reviews of all of these flopticals.)

Government Computer News dated January 7 carried a front-page story reporting that there are 225,000 laptops in federal offices and projects that big users like the IRS and Environmental Protection Agency will help boost this number to about 440,000 by the end of 1992. A major inside feature covers the use of laptop systems in the government.

The January 5th *Science News* carries a fascinating article about Cornell University research into creating microstructures on semiconductor surfaces already covered by metal coatings. Such research could eventually lead to new

higher-density data storage systems.

The *Wall Street Journal* (WSJ) reported on Monday, January 7, that Asian investment in U.S. technology companies comes not just from Japan but also from Taiwan, Singapore, and South Korea.

Updating one item in last week's Roundup, the WSJ for Wednesday, December 8, announced Microsoft's expected same-day unveiling of Excel 3.0, list price \$495, in Cambridge, Mass., home of rival Lotus Development. Lotus, already wounded by Borland International's price-cutting tactics, is widely expected to lose more market share.

According to Wednesday's WSJ, Chips & Technologies, San Jose, Calif., has developed a single-chip product, PC Video, that lets computers show television-style images.

Thursday's WSJ also carried an article on the new trend of personal computer advertisements—stressing power and performance. Among the companies making up this trend are Advanced Logic Research, IBM, and Sun Microsystems.

The January 7 issue of *Computerworld* carried a story from the U.S. Department of Commerce that projects strong growth in the computer industry, despite an overall slowdown in the economy. According to author Gary Anthes, Commerce has projected that hardware sales will climb 5.9 percent, chip sales will jump nearly 9 percent, and software revenues will increase 20 percent.

Sony's CD Write-Once System, a desktop-size hardware system that writes data to a CD-ROM compatible disc, has won *CD-ROM Professional Magazine's* 1990 Professional Development Product Award.

This week's *Computerworld* has a story on problems the Army's information services command is having situating equipment in Saudi Arabia—the story is dated before the start of the war.

Computer Reseller News for January 14 carries the results of a major survey of 100,000 computer users, showing that 80286-based systems make up about 40 percent of the installed base in these businesses, with nearly 2.5 million 8088/86-based systems still in use. The survey also indicated that Fortune 1,000 companies plan to make a surprisingly low 0.1 percent of their purchases from the plethora of hot new 486-based computers.

The WSJ reported on Wednesday, January 16, that Compaq can't meet consumer demand for its 60-megabyte LTE 386/20 laptop computer, listed at \$6,000, due to shortage of key parts.

Thursday's *Journal* reported on the dismissal of 500 workers by Wang Laboratories, Lowell, Massachusetts, shortly before Wang's expected agreement to license Sunnyvale, California-based Mips Computers Systems' new computer design.

Mentioned in Thursday's WSJ were brief items on both the faster-than-expected switch from traditional computers to massively parallel computers, and software which automates scheduling tasks.

Friday's *Journal* reported shortages of Intel's 80386SX processor chips, which are affecting companies trying to market the latest notebook computers.

Franklin To Show Electronic Bible At CES
MOUNT HOLLY, NEW JERSEY, JAN

Industry Leading Software at Unbelievable Savings

- Powerful Software Programs
- \$1629 Cdn. Retail Value!
- Original OEM Manufactured & Packages
- All products supported by respective manufacturers' warranties
- Super Savings!

- Trademarks & Packaging are the exclusive property of original manufacturers
- Guarantee, if not fully satisfied return within 10 days of receipt for full refund
- Systems requirements: DOS 2.1 or greater, 512K RAM, 1 Floppy with hard disk.

ALL YOURS FOR \$189

YOU SAVE \$1440

Accounting with Pictures

If you have always considered accounting a chore, a tedious task, we have the answer for you! Consider Accounting with Pictures (AWP), an easy-to-use, fill-in-the-blanks, Canadian-made accounting program. AWP is simple, straightforward, and easy-to-use, but powerful enough to handle all the accounting for your growing business. It's even ready for GST! AWP comes full integrated with General Ledger, Invoicing, Statements, Accounts Receivable, Accounts Payable, Payroll, Job Costing, Bank Reconciliation, Budgeting and much more. The program runs real-time, giving you immediate information to run your business. Included is an integrated 152 page manual that can be easily printed or viewed on screen at any time.

Retail \$229

WordStar

Whether you are producing a simple memo or a professional-looking newsletter, it's easy and fast with WordStar 5.5. The instant you fire up WordStar, you can start typing, adding bold, italics, underlining, and much more. It's easy with the Pull-Down menus. If you currently use any other word processor, don't worry. With WordStar, you get StarExchange, a \$149 value from Systems Capability Corporation. StarExchange lets you convert your word processing files, including embedded formatting commands, to and from all the major word processors.

Retail \$495

KeyForm Designer Plus

KeyForm Designer is a complete forms creation and management system, designed exclusively to quickly create forms, from simple to sophisticated, on a PC.

Retail \$179

KeyMenu

KeyMenu is the ultimate menu management system and DOS shell. KeyMenu organizes programs and directories into friendly menus.

Retail \$79

KeyGrammar-Checker

Key Grammar-Checker is your personal proofreader, catching those errors in the privacy of your PC before they embarrass you in public. KeyGrammar-Checker examines every word, sentence and paragraph you write against 6500 rules of grammar, style, and usage.

Retail \$99

KeyChart 2000

This is one of the most powerful TSR (memory resident) business presentations graphics packages on the market today. This powerful standalone graphics application (which requires only 10K of RAM), most often compared to Harvard Graphics, produces over 15 different chart types, including text and organization charts.

Retail \$299

KeyMailer

Everybody has a mailing list. Helping people to maintain theirs on a computer is how KeyMailer won a PC Magazine's Editor's Choice Award.

Retail \$249

This incredible offer is yours for only \$189 — no strings attached, no gimmicks. 7 powerful software programs with manuals, diskettes, registration cards, and phone numbers for technical support. Act now and take advantage of this incredible offer — for only \$189. Where else can you find such an offer as this? That's right — NO WHERE. So order today and receive your 7 software programs for only \$189.

PLEASE PRINT ALL ORDER INFORMATION CAREFULLY

Name: _____
 Address: _____
 City: _____ Postal Code: _____
 Prov: _____ Fax: () _____
 Phone: () _____ Exp. Date: _____

METHOD OF PAYMENT:
 Mastercard Money Order Cheque enclosed
 Card Number: _____

Name on Credit Card: _____
 Signature: _____

Make all funds payable to:
 VANTAGE TECHNOLOGIES INC.
 #304-1324 11th Ave. S.W.
 Calgary, Alberta T3C 0M6
 Phone: (403) 244-5624
 Fax: (403) 244-9270

PHONE AND FAX ORDERS BY CREDIT CARD PAYMENT ONLY

DISK SIZE: 5.25" 3.5"
 (Check one size only)

QTY	UNIT PRICE x \$189	TOTAL
Shipping & Handling*		\$10.00
Sub Total		
GST (7%)		
PST		
Total Enclosed		

* Add \$5 for each additional order

VANTAGE

VANTAGE TECHNOLOGIES INC.,
 304-1324 11th Avenue S.W.,
 Calgary, Alberta T3C 0M6
 Phone: (403) 244-5627
 Fax: (403) 244-9270

7 (NB)—Las Vegas may not seem the most likely place to sell Bibles, but Franklin Electronic Publishers' new product isn't quite like most Bibles anyway. At the Winter Consumer Electronics Show January 10-13, Franklin will introduce a hand-held electronic edition of the New International Version Bible.

The Franklin Electronic Bible weighs 11 ounces and measures 5.5 by 5.5 by two inches, with a small QWERTY keyboard and an eight-line supertwist display, company spokeswoman Mindy Savar told Newsbytes. It stores the complete text of the New International Version Bible on memory chips. It also comes with a carrying case.

The New International Version joins two other electronic Bibles already published by Franklin: the King James and Revised Standard Version Bibles launched in 1989.

The New International Version, licensed from Zondervan Publishing House, is written in contemporary language. Franklin's electronic version enhances the printed work by permitting the reader to probe through the Bible's entire text at electronic speed. The technology offers instant access to favorite or even unfamiliar passages in seconds, according to Franklin.

For instance, if a reader types in the words "meek" and "inherit," the electronic edition will search through the entire Bible and instantly lead the reader to the two books in which these words appear together. The search function can search simultaneously for all forms of any word.

The electronic New International Version Bible will sell for US\$299.95, Savar said.

Franklin publishes a library of electronic reference books, including the Wordmaster electronic thesaurus series and the Language Master line of electronic dictionaries, as well as the Spelling Ace spelling corrector. Contact: Franklin Electronic Publishers, 609-261-4800.

LANs

3Com, Microsoft Announce Pact

REDMOND, WASHINGTON, JAN 8 (NB)—Microsoft and 3Com Corp. have announced a pact whereby 3Com will license software to Microsoft for inclusion in future versions of Microsoft's LAN Manager local area network software.

LAN Manager is to include 3Com's Apple Macintosh and Novell NetWare connectivity functions.

Microsoft also licensed 3Com's X.500-based directory services software, which provides LAN users with global naming capabilities.

3Com also announced it will offer LAN Manager products with its 3Server line of local area network file servers. Contact: 3Com, 408/764-6621; Microsoft, 206/882-8080.

3Com Lays Off 12% Of Staff

SANTA CLARA, CALIFORNIA, JAN 9 (NB)—3Com Corporation has announced a layoff of 235 workers, 12 percent of its workforce, in a company-wide reorganization effort. The firm is putting its workgroup product line up for sale, and will concentrate energies on its products for network connections. The

cost of the reorganization is pegged at \$45 million.

3Com currently has 1,953 employees, before the layoff. Most of those whose jobs are being terminated are in the company's Santa Clara headquarters.

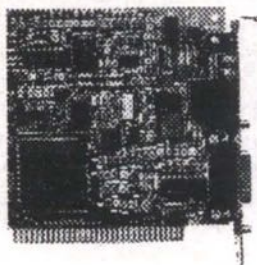

Laptops

NEC Introduces Portable Cellular Workstation

RICHARDSON, TEXAS, JAN 18 (NB) — NEC has introduced what it calls a first: a portable cellular workstation. A joint effort between NEC America and NEC Technologies, two of the Japanese firm's U.S. subsidiaries, the workstation combines NEC America's P300 portable phone and the 6.5-pound UltraLite 286V or 6.8-pound 286F notebook computer from NEC Technologies.

Mark Marangella, sales and market-

ing director for NEC America's Mobile Radio Division, said in a press release, "The Portable Cellular Workstation gives mobile professionals computing and communications capabilities when and where they are needed—including fax capabilities via a fax card on the notebook."

The phone offers features available on full-size office phones such as speed-dial and memory search. It includes communications software which can handle either facsimile transmissions or electronic mail.

Both computers run at 12 megahertz with an Intel 80286 processor and fea-

GST ??

What is GST?

Government Stupidity Tax

Gouge 'em Slowly Tax

Grand Scheme Tax

Go Slow Tax

Gouge & Screw Tax

Gigantic Social Tax

Grab & Steal Tax

Gone to Senate Tax

Great Slave Tax

Going South Tax

Are you ready for it?
 Avoid a Gigantic Software Trauma.
 Get Started Today. Get Syspro Tax.
 We have the system to help you.

or Call us at 298-8200
 Fax 298-3430



202 - 4190 Lougheed Hwy., Burnaby, B.C. V5C 3Y5

ture a 20-megabyte hard drive and 1 megabyte of memory, expandable to 5 megabytes. The 286V notebook computer has a 10-inch backlit VGA display for graphics-oriented applications. The 286F notebook has an 8.8-inch black and white display with VGA fonts for text-oriented applications. Both can be operated either manually or automatically, with a tape recorder jack and the capacity for transmitting cellular facsimiles. It also allows use of an optional headset which has a speaker/microphone jack for hands-free use.

The P300 phone can be powered via a cigarette lighter adapter, AC or nine-volt battery. The UltraLite 286V or 286F

notebook computer operates on its own batteries which can be recharged via a special accessory for the cigarette lighter, which is sold separately. Contact: NEC America, 214-907-4000.

Radio Shack Enters Notebook Computer Market

FORT WORTH, TEXAS, JAN 16 (NB)—Radio Shack has entered the crowded notebook computer market with a 6.7-pound 286-based unit priced at \$2,499.

For that price, the new Tandy 2810 HD comes with a 16 MHz processor, VGA graphics, and internal 20 megabyte

(MB) hard disk with an access time of 23 milliseconds, one MB of random access memory (RAM), a 3.5-inch diskette drive, and MS-DOS 4.01. The unit is 1.7 inches high, 12.2 inches wide and 10 inches deep. Battery life for the unit is estimated at three and a half hours of continuous use. The display is a back-lit LCD array that can show scales of gray. A battery life indicator is located on the top of the case, and the unit includes a Resume feature that lets the users start up at the point in the software where the unit was turned off. Contact: Radio Shack, 817-390-3487.

Laptop Of The Year?

WATERTOWN, CONNECTICUT, JAN 2 (NB)—Psion's MC400 laptop, introduced internationally in July and in October in the United States, is said to have "strongly impressed the judges because of its revolutionary use of power," said Psion spokesperson Alfred Belasco, commenting on the laptop's recent award of Laptop Computer of the Year from *Chip* magazine.

The system runs for up to 70 hours on standard double-A batteries. It makes use of a CMOS 80C86 processor, flash card memory and efficient screen management to greatly reduce power requirements. Belasco stressed the "amazingly long battery life of the unit." He called attention to the statement of the judges, representatives of trade journals of seven European countries and Japan, which said that the MC400 represents "the most significant realization of the truly portable computer with a 60-hour battery life and the use of solid state disks (SSDs) for data storage."

The judges made their selections based on the following criteria: particular significance for market development; technical innovation; and complete product development and market availability.

Belasco also told Newsbytes that the MC400, at 4.5 lbs., was one of the lightest computers in the competition and that it was also praised for its intuitive, graphic user interface and complete multitasking capabilities. He said that the MC400, with a suggested introductory retail price of US\$1,795, includes a proprietary operating system, a text processor, spreadsheet, terminal emulation and transfer software to "intelligently move information to and from Apple Macintoshes and MS-DOS systems."

He said that coming new additions to the product include "a full-featured word processor and a more-intuitive, friendly transfer system to and from the Macintosh." Contact: PSION Inc., 617-237-8538.

Advanced Logic Research Ships Notebook

IRVINE, CALIFORNIA, JAN 2 (NB)—Advanced Logic Research says it is shipping its Venture 16SX Notebook PC, \$2,795, a machine weighing 7 pounds, measuring 12 inches by 8.6 inches by 2 inches.

Dave Kirkey, vice president of international sales and worldwide marketing at ALR, says the unit is small enough to carry comfortably in a standard-sized briefcase. It comes packaged with a 16-MHz 386SX CPU, an 8.5-inch diagonal LCD backlit display, and 1 MB of interleave page-mode memory (expandable to 5 MB). There are various drive options and a rechargeable battery that offers up to 3 hours of continuous work time.

ALR is also shipping the ALR PowerPro upgradeable dual-processor server PC, which it claims rivals the Compaq SystemPro, at \$7,495.

Contact: ALR, 714/581-6770.

IBM World

Intel Chalks Up 34% Increase In Profits

SANTA CLARA, CALIFORNIA, JAN 18 (NB) — Snubbing its nose at the worldwide economic recession, Intel Corporation says profits are up 34 percent, or 80 cents per share in the quarter

AFFORDABLE LUNCHEON FOR THE POWER-HUNGRY

OCTEK 486-25 Mhz MAIN
B O A R D

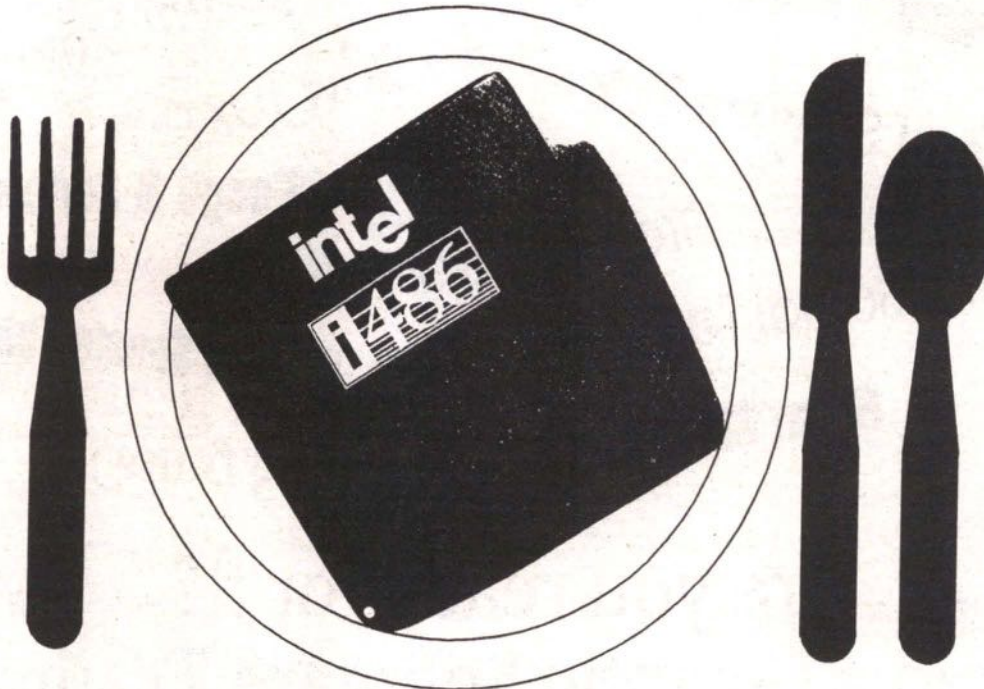

LANDMARK 114 POWERMETER 11.1
6-LAYER PCB, BURST MODE TRANSFER
4-WAY PAGE INTERLEAVING MODE
LITHIUM BATTERY, ON BOARD POWER GOOD
EXPANDABLE TO 16MB & 128K CACHE (OPTIONAL)
SHADOW RAM & MEMORY REMAPPING

Manufacturer & Exporter

STANDARD COMPUTRONICS LTD.

Head Office & Factory:
Unit B1, 11/F., Block B, Hong Kong Industrial Centre,
489-491 Castle Peak Road,
Lai Chi Kok, Kowloon, Hong Kong.
Tel: 785 7783 Telex: 48719 STDCC HX
Fax: (852) 785 8056

Showroom:
STANDARD COMPUTER CENTRE
Shop 84-86, 1/F., Golden Computer Centre,
94 Yen Chow Street, Kowloon, Hong Kong.
Tel: 360 2038, 386 8276
Fax: (852) 725 1422

Canada Office:
Cambridge Industrial Centre,
Unit 333, 13988 Cambie Road,
Richmond B.C. Canada.
Tel: (604) 273 7886
Fax: (604) 273 7889



ended December 29, 1990. Profit increased to \$163.9 million over \$122.7 a year ago.

Sales are \$1.04 billion for the period. Annual sales stand at \$3.92 billion, up from \$3.12 billion from the previous year. Net income is up 66 percent from a year ago to \$650.3 million.

The strong growth is attributed to Intel's line of 386 and 486 microprocessors, which are being gobbled up by micro makers worldwide at twice the rate they were in 1989.

Starlite Ships \$50 Wordstar Workalike

PORT HADLOCK, WASHINGTON, JAN 16 (NB)—Starlite Software has announced it is shipping version 1.6 of its Galaxy Lite, a commercial version of Omniverse's Galaxy shareware word processor. Galaxy's main claim to fame has been that it features the option to drive the package using Wordstar commands as well its own.

The much-criticised snag with the shareware package was that, while it included the facility of having two files open on-screen at once, the maximum size of any file could only be 64K.

Galaxy Lite 1.6 appears to have got past the 64K file size limit while at the same time offering Wordstar command compatibility, plus a host of other features including the ability of having two file windows open on-screen at the same time. Features of the package include a 70,000 word spell-checker, multiple document printing and a choice of menu or keyboard command interfaces.

Galaxy Lite 1.6 requires a PC with a single floppy drive plus at least 256K of available memory. The package is available now at \$50, this price holding good for shipment anywhere in the world. Contact: Starlite Software, 206/437-0116.

Informix Posts Loss, Will Lay Off Staff

MENLO PARK, CALIFORNIA, JAN 18 (NB) — Informix Corporation expects to lose \$6 million for its fourth quarter, and post a loss for the year. The software company, famous for its Wingz spreadsheets for various platforms, will also lay off 15% of its 1300 employees and restructure.

Informix says the loss includes severance pay and benefits from the layoff, and the write-off of previously capitalized software development projects.

Lotus Marketplace Slammed By Computer Pro Group

WASHINGTON, D.C., JAN 16 (NB)—Computer Professionals for Social Responsibility (CPSR) has announced that it will oppose the release of Lotus Marketplace, a CD-ROM based marketing information database for the Apple Macintosh. Marketplace contains personal information on consumers throughout the United States.

In announcing the decision to oppose Marketplace, CPSR President Eric Roberts said, "From a privacy viewpoint, Marketplace simply fails. As computer professionals, we have a responsibility to make the public aware of this shortcoming. We hope that Lotus will reconsider their plans and decide not to release Marketplace."

Roberts added, "There is a lot of work to do on the privacy front, but opposing

Marketplace is a good first step."

CPSR's statement states that privacy experts feel that selling information on individuals without first consulting them violates the Code of Fair Information Practices. The Code, developed in 1973 by a government study committee chaired by Willis Ware, a computer security expert who now heads the federal government's Computer Security and Privacy Advisory Board, places a responsibility on data holders to ensure that information is accurate, complete, and reliable. It requires that companies such as Lotus provide individuals with access to personal records and also an opportunity to review the records and to make

corrections. The Code prohibits transferring personal information without first obtaining consent.

Although the CPSR press release listed a telephone number for Lotus' Janice Brown as a press contact to be called to discuss the CPSR statement, Ms. Brown told Newsbytes that she had not been contacted by CPSR concerning a statement and was not aware of its content. She said that Lotus would have to obtain a copy of the CPSR release and review it before commenting. Contact: CPSR, 202-775-1588.

Sony To Set Up U.S. Software Firm

NEW YORK, NEW YORK, JAN 9 (NB)—Sony Corporation has announced that, on January 15th, it will form Sony Software Corporation, a new U.S.-based company which will encompass and coordinate Sony's present and future software activities under one entity.

Norio Ohga, president and chief executive of Sony Corporation, will be chairman of Sony Software while Michael P. Schulhof, a member of the board of directors of Sony Corporation, will be president of Sony Software.

GeoWorks

A Macintosh clone at last?

**Yes, but better—
It's Macintosh-clever
on an IBM-compatible**

from \$1289 monochrome system

from \$1616 colour system



- GeoWorks Ensemble® software
- IBM-compatible computer
- 40 Mb hard drive

*According to many, users these packages
BEAT the Macintosh for value and ease of use!*

Other rave reviews:

PC World (Nov. '90): "GEOS could be the biggest thing since Windows."

PC Magazine (Nov. '90): "You owe it to yourself to understand GEOS and the choices it offers."

InfoWorld (Nov. '90): "GEOS appears to be superior to Windows in everything but size, visibility, and the number of available applications."

Computer Paper (Jan '91) "I could not find a single bug in PC/GEOS."

WINNER of the draw for a PAL286 computer at the Pacific Rim Computer and Communication Show was Ray Boisvert, of Burnaby.

■ LEASING ■ PERSONAL FINANCING ■ CUSTOMER SUPPORT ■ NETWORKS ■ RENTALS FROM \$10 A DAY



STRACHAN



COMPUTERS LIMITED

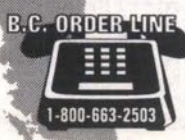

NORTH VANCOUVER
HEAD OFFICE
1336 MAIN STREET, V7J 1C3
MON-SAT 10 a.m.-6 p.m.
TELEPHONE: 984-8500
FAX: 984-6486

WEST VANCOUVER
202-1760 MARINE DRIVE, V7V 1J4
MON-FRI noon-5 p.m.
(other times by appointment)
TELEPHONE: 926-6424

COQUITLAM
LINCOLN CENTRE-SUITE 106
3020 LINCOLN AVENUE, V3B 6B4
MON-FRI noon-5 p.m.
(other times by appointment)
TELEPHONE: 942-0370

Doug & Colleen's

MS-DOS SHAREWARE

1279 Kingsway (at Clark)
Vancouver, B.C. V5V 3E2

872-1022

BRING IN THIS AD AND SAVE \$2.00
On Purchases of \$10.00 or More

OVER FIFTY NEW TITLES!

Sony Software Corporation will be headquartered in New York and will include Columbia Pictures Entertainment, Sony Music Entertainment, and Sony's interest in Columbia House. The new firm will also coordinate and develop computer-related software businesses, including CD-ROM and potential future formats.

Announcing the formation of Sony Software, Ohga said, "Uniting our software companies in one structure will enhance our worldwide initiatives. I am pleased with the results demonstrated by the creative efforts of the 18,000 members of Sony's software concerns worldwide. These individuals and operations have been exploring inventive ideas and applications for software entertainment. Sony Software has been formed to meet the challenge of globally coordinating these efforts."

Koh Shimitzu, Sony's director of cor-

porate communications, told Newsbytes, "This is the bringing together of all of Sony's activities in the software area. Sony has various operations in the category that we call software. While the largest concentration is in video and audio, the new firm will also have responsibility for any activities that we may pursue in the area of computer software." Contact: Sony, 212-418-9479.

XTree Gold 2.0— New Features, Environmental Concern

SAN LUIS OBISPO, CALIFORNIA, JAN 7 (NB)—XTree Company has announced the release of XTreeGold version 2.0, the latest edition of its hard-disk file management program. In a new marketing approach following the success of the company's recent SAFE am-

nesty program, this new release marks the beginning of an XTree environmental program.

XTree Company will plant a tree for every user registration card returned. In keeping with this ecology-minded approach, the packaging and manual for the new product, in fact everything connected with the product except the diskettes it is on, is being made from recycled materials.

The latest version of the program is said to be both more sophisticated and easier to use. The company claims that version 2.0 "simultaneously shields users from awkward DOS commands while giving them instant DOS power via pull-down menus and the enhanced XTree Application Menu." The company describes the new XTreeGold interface as an intuitive, powerful operating environment.

FAX O'MATIC

Automatic Fax Switch

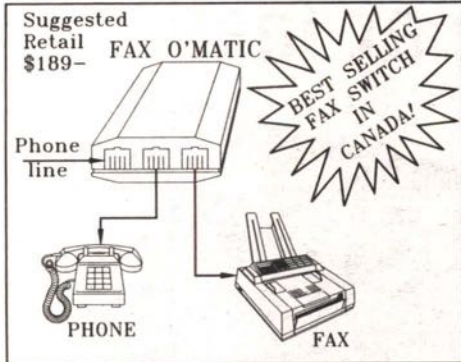

SAVE PHONE LINE CHARGES!
Eliminate monthly phone line expense and installation cost

DEALERS WELCOME!

- ✓ **TWO OUTPUT JACKS** - Share your FAX and Telephone on one phone line
- ✓ **SURFACE MOUNT TECHNOLOGY** - High quality and reliability
- ✓ **SMALL, SIMPLE TO INSTALL** - Just plug and play
- ✓ **BROAD COMPATIBILITY** - Works with most fax machines
- ✓ **TONE OR PULSE DIAL**
- ✓ **ANSWERING MACHINE OPTIONAL** - Works with or without answering machine
- ✓ **FULLY AUTOMATIC** - No programming required
- ✓ **DOC AND CSA APPROVED**

- ✓ **THREE OUTPUT JACKS** - To switch 3 different distinctive ring types
- ✓ **SURFACE MOUNT TECHNOLOGY** - High quality and reliability
- ✓ **SMALL, SIMPLE TO INSTALL** - Just plug and play
- ✓ **SOLID STATE SWITCHING (Patent Pending)** - No relays, means high reliability and longest life
- ✓ **BUILT IN EXCLUSION** - Prevents phone line access when the line is in use
- ✓ **LOW RINGER EQUIVALENCE** - Does not load the telephone lines significantly
- ✓ **OPERATES AT LOW RING VOLTAGES**
- ✓ **DOC AND CSA APPROVED**

Available at: FUTURE SHOP, RADIO SHACK AND OTHER FINE STORES
Contact: Val Hutchinson at TGI TECHNOLOGIES LTD.
Ph: (604) 872-6676 Fax: (604) 872-6604

RING O'MATIC

Automatic Distinctive Ring Selector

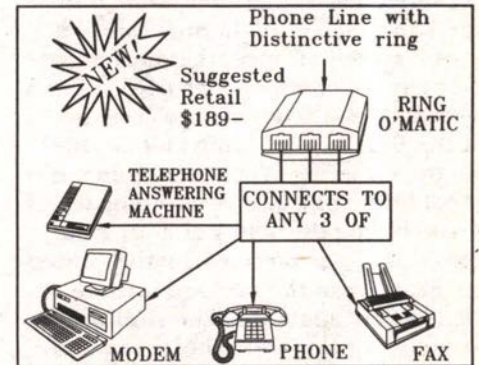

PHONE LINE POWERED!
No batteries or AC adaptors

TCS the Computer Store

#7—11220 Voyager Way, Richmond, B.C.
Phone : (604) 273 - 8443 Fax : 273-9142
VANCOUVER - CALGARY - TORONTO

SUPERFAST LOTUS

286 - 16 AT
84 Mb 12ms

Super VGA System
- Includes All The Extras

\$1888.00

Competition's Price \$1999.00

SUPERSPEED FOR WINDOWS LOTUS

386SX - 20

84 Mb 12ms
Super VGA System

\$2388.00

Competition's Price \$2449.00

THE ULTIMATE IN CAD/CAM LOTUS

386-33 64

84 Mb 12ms

Super VGA System

\$2888.00

Competition's Price \$2999.00

WE DID OUR HOMEWORK "COLLEGE COMPUTER"

286-12.....\$ 798.00

386sx.....\$1188.00

386-25.....\$1488.00

386-33.....\$1788.00

ALL COLLEGE SYSTEMS HAVE:

101 Keyboard - 40 mb 24ms HD

1 mb ram - 1.2 floppy - Mono card

12" mono monitor - 1 yr warranty

DOS \$70.00 WITH SYSTEM

Sharp Super Sale

Sharp 6220 Notebook

\$3488.00

Mfg. Suggested Retail \$4895.00

RENTALS

- 286 Systems Starting at \$150.00/Month
- 386SX Systems Starting at \$195.00/Month
- 386 Systems Starting at \$300.00/Month

Call For A Current Rate Sheet

**We Will Configure To Your
Specs...**

Also: Daily - Weekly - Yearly

The Extras Included With All Lotus Super VGA Systems

- .28 Dot Pitch Colour Super VGA Monitor
1024 x 768 Resolution
- 1 MB Super VGA Card
- 84MB 12 ms IDE HD 1:1 Controller
- 1 Megabyte of RAM
- 1.2 MB 5 1/4" Floppy
- DOS 4.01 - 101 KEYBOARD
- Deluxe Tower Case

**2-YEAR
WARRANTY**

Serving Richmond, South Vancouver, New West and Delta.



SMARTER BUYERS ALWAYS ASK ABOUT...

- How long have you been in business?
- Floppy Disk Drive - What Brand?
- Hard Disk - Voice Coil?
- Monitor - Dot Pitch?
- Ram Chips - ?n-Second

check with the system motherboard
Quality & Reliability & Compatibility

GO FOR THE SMARTEST

ATTENTION
Before you buy, don't forget to take a close look at...

CCS Canadian Designed 8-Layer Motherboard will clear out all the errors from:

- SYSTEM HAND-UP due to low quality socket/slot, etc.
- REGISTER ADDRESSED INCOMPATIBILITY.
- SYSTEM FREEZED due to overheating.

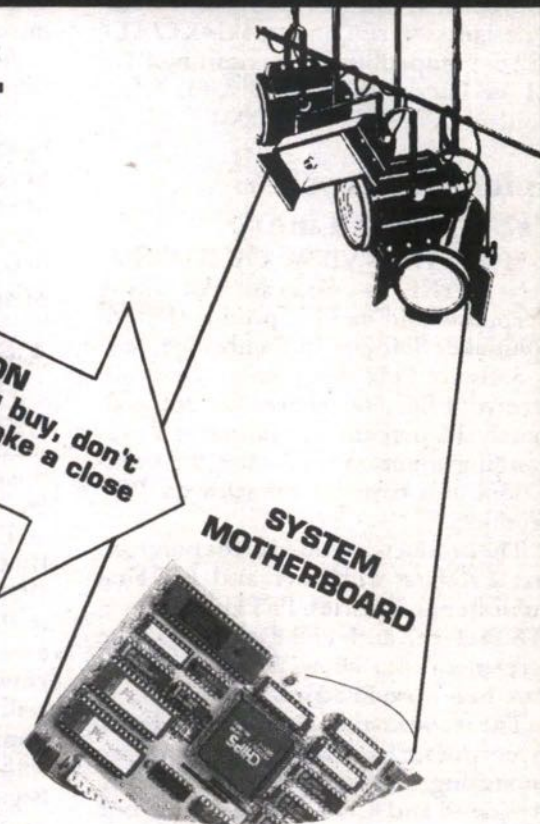

EISA-i486 Micro System

Licensed Phoenix BIOS, 33MHz i486 Microprocessor with integrated coprocessor and cache controller with 8KB internal cache RAM
Optional second-level cache memory with 128KB RAM configurations: 2,4,8,10,16,32 or 64MByte, Eight expansion slots: Six full-sized 8/16/32-Bit EISA Slots Two 8-Bit ISA slots
Coprocessor socket for Weitek 4167



\$4,999.00 (if 25MHz: \$3,799.00)

CCS 386/33MHz Cache System

Canadian Designed 8-layer most reliable motherboard
Licensed Phoenix BIOS, Intel 80386-33MHz CPU
Intel 82385 Cache Controller with 32K/25nS Caching

\$1,999.00

CCS 386/25MHz System

Canadian Designed 8-layer most reliable motherboard
Licensed Phoenix BIOS, Intel 80386-25MHz CPU
Supporting 80387-25 or 80287 Math Co-processor

\$1,549.00

CCS 386SX/20MHz System

Intel 80386SX True 20MHz CPU, Licensed Phoenix BIOS
Canadian Designed 6-Layer most reliable motherboard
RAM expandable to 8MB on-board

\$1,389.00

CCS 386SX/16MHz System

Intel 80386SX CPU, Licensed Phoenix BIOS

\$1,289.00

CCS 286/12MHz System

80286 CPU, Licensed AWARD BIOS,
Up to 4MB RAM On-brd

\$829.00

All Above Systems include:

- 1MByte RAM installed
- 1.2MB Floppy Disk Drive
- 40MB/28mS Harddisk
- 16Bit 1:1 Controller
- I/O Ports
- 12" TTL Amber Monitor
- Enhanced 101-Key Keyboard
- Small Footprint Case

Detailed Technical Spec Brochures
Performance Index Compared to Named Brands
& End-users' Reference Available

Prices Subject to Change without Notice

WHY SHOULD YOU BUY FROM CCS?

The Best "Price-to-Performance" Ratio and
Professional After-Sale Technical Service

Computer and Communication Systems Ltd.

1235-1237 Nanaimo St. Vancouver V5L 4T5

Ph: 251-3588 FAX: 251-5125

Added features also include an "Oops!" command for retrieving deleted files with a keystroke, viewers, the industry standard ZIP format, and directory comparisons of two directories even if they are not on the same drive.

XTreeGold carries a suggested retail price of \$149 with upgrades to earlier versions available for \$35. It comes on both 3.5 inch and 5.25 inch diskettes and is designed to run on any PC/XT/AT/PS2 or compatible system running DOS 3.1 or later with at least 256K RAM. Contact: XTree, 805-541-0604.

Spinnaker Buys PFS Product Line

MOUNTAIN VIEW, CALIFORNIA, JAN 17 (NB) — Software Publishing Corp. has sold its PFS: product line to Spinnaker Software in Cambridge, MA.

Software Publishing Corp. says it will receive 1,861,000 shares or approximately 16 percent of Spinnaker's outstanding common stock after the transaction, and royalties on sales on PFS: products.

The products included in the purchase are: PFS:First Publisher and PFS:First Publisher accessories, PFS:First Choice, PFS:Preface, and PFS:Easy Start. The agreement also allows Spinnaker Software to license PFS:First Graphics.

The move marks a shift from end-user to corporate computing for Software Publishing, according to Fred Gibbons, president and CEO. "The sale of our PFS: line now allows the company to direct all of its resources to developing products for the corporate marketplace," he said in a published statement.

"Our goal is to help the business pro-

fessional access and present information enabling them to make better decisions, faster. At the same time, we believe PFS: customers will be well-served by Spinnaker Software, which understands their unique product and support needs."

Spinnaker Software says it is readying a line of Windows 3.0 applications that will be marketed under the PFS: brand. The first of the new products will be introduced this quarter.

As far as service goes, Software Publishing Corp. will continue to support the PFS: products over a transition period of several months. The employees who worked on the PFS: products will be offered other positions within the company, a company statement says. Contact: SPC, 415/335-6440; Spinnaker, 617/494-1200.

A 68000 CPU In An IBM?

Meanwhile, IBM Japan is preparing to release five to six kinds of low-cost personal computers for the Japanese market this spring. They include notebook-type PCs and home PCs.

These machines will be equipped with IBM's new disc operating system called DOSJ4.0/V, which will also be provided to the compatible makers. Prices of the new machines are expected to range between 150,000 yen (\$1,150) to 300,000 yen (\$2,300). Interestingly enough, the home-use PC will be jointly developed with Tokyo-based game machine maker Sega Enterprise. It will be a dual CPU machine, which will be equipped with a 68000 chip and an 80286 chip. According to the Nikkei Personal Computing magazine, the machine will be code named "Terra" and will look like the PS/1. The system will initially be released in

Japan in April.

Contact: IBM Japan, 03-3586-1111.

Ashton-Tate Appeals dBase Copyright Case

TORRANCE, CALIFORNIA, JAN 17 (NB) — The judge who ruled that Ashton-Tate violated Fox Software's copyrights to the dBASE programs has denied Ashton-Tate's motion for reconsideration of his order. Ashton-Tate says it will take the matter to a higher authority — the Ninth Circuit Court of Appeals in San Francisco.

Judge Terry J. Hatter Jr. did, however, grant Ashton-Tate an early appeal for his order.

"While we were disappointed that Judge Hatter did not approve our motion for reconsideration, we were pleased that he eased our path for appeal. And this puts people on notice that this is not a final judgment," said William P. Lyons, Ashton-Tate president and chief executive officer.

He stressed that the dBASE software remains protected outside the United States by the Berne Convention on copyrights and in the U.S. by license agreements. "We remain very confident that our position will ultimately prevail in the Court of Appeal," he said.

File Express 5.0 Released

DUVALL, WASHINGTON, JAN 18 (NB) — Expressware Corporation has announced release of version 5.0 of its flat file database program File Express. The updated software will be available February 15, 1991. List price is \$99.

File Express 5.0 runs on IBM and compatibles and requires only 512K of

random access memory (RAM) and two high-density floppy drives or a hard drive. The program is written in C. It has relational look-up capabilities, and will accommodate over two billion records per database, with a maximum of 200 fields per record. Each record can contain up to 4000 characters.

Also included are mathematical calculations with accuracy up to 14 digits, and calculated fields are supported. Reports can be sorted on up to 10 fields simultaneously, with three levels of sub-totals. The program has the ability to search and replace, or search and delete, records, as well as automatically search for duplicate records within a database or between two separate databases. Field formats can be changed and fields added or removed after the data has been entered, much like the popular Q&A program from Symantec.

Other features include query and reporting facilities, with reports being generated in columnar or multi-line format. The user can select individual records or record ranges for output.

All printing including mailing labels can be in regular or condensed mode. File Express 5.0 supports network file locking, and can exchange data between File Express and Lotus, dBASE or Word Perfect formats. It is not copy protected and has context-sensitive Help screens for new or occasional users.

File Express can be ordered directly from Expressware Corporation by calling 800-753-FILE (3453). Visa and MC accepted. The purchase price includes phone support, a newsletter and automatic notification of updates. Lukey says there are presently 26,000 registered users since the program's introduction

Novell

Networking Support & Upgrades

We can handle any size of network

(We are not an authorized Novell Dealer)

AER ELECTRONICS CORPORATION

#4-11460 Voyageur Way
Richmond, B.C. V6X 3E1
Tel. 279-8867 Fax. 279-8821

**Lantastic
Networking and Support**
We can link 2 to 120 computers
together at a reasonable price.

No job is too small

SPECIAL OF THE MONTH HP Laser III \$2250

HP Memory Card & 1MB\$170
NEC 3D 1024 x 768\$825
Conner 104MB 25ms IDE\$595
Legend 14" 1024 x 768\$395
Morse 14" 1024 x 768\$459
Paradise OEM VGA 512K\$145
Laptop DataWorld 386SX ..\$3250
Laptop Daewoo 386SX\$2675
Summagraphics 12"x12".....\$495

ALL SYSTEMS INCLUDE:

41MB Voice coil, Mitsubishi HD
1:1 MFM hard/floppy Controller
1.2 or 1.44MB Teac Floppy Drive
200W PS, 1MB RAM, AMI BIOS
12" Mono Monitor & Graphics Card
Serial, Parallel & Game Port
101 key enhanced keyboard

Warranty is 1 year parts & labour

UPGRADE OPTIONS

65MB Voice coil HD\$50
Tower Case\$50
DOS 4.01\$70
1.44Mb or 1.2 MB FD\$85
SmartOne 2400 int modem.....\$99
SmartOne 2400 ext modem.....\$129
100 MB voice coil HD\$295
VGA Standard 640x480\$325
VGA Color 1024x768\$425
TriCom 1MB Ultra VGA\$445

Special 286-12MHz

VLSI Chip set
Expandable to 4 MB
(Exp. RAM \$85/Mb)

\$950.00

Starter Special 386SX-16MHz

Runs all latest Software
Expandable to 4 MB
(Exp. RAM \$85/Mb)

\$1325.00

Business Class 386DX-25MHz

C&T 25MHz Chip set
Expandable to 8 MB
(Exp RAM \$100/Mb)

\$1650.00

Professional System 386-33MHz

64K Cache
Full size Motherboard
Expandable to 8 MB

\$2049.00

in July 1984.

The most significant change in the latest version is its record capacity. The first release could handle about 10,000 records. Lukey said that "the interface appears very uncluttered to the user. It's much like using a card file, the learning curve is very short, and it is very popular with people who need a handy reference file that is easy to learn and use." Contact: Expressware Marketing, 206-788-0174.

Telecom

Standards A Problem In E-Mail Transfers

CAMBRIDGE, MASS., JAN 8 (NB)—For electronic mail vendors, 1991 will mean struggling with two different standards—the MHS mail-handling standard and the X.400 message-passing standard. Grant Harris, president of Workframe, which makes MHS software, said in an interview with Newsbytes the former scheme is becoming the preferred way of linking internal mail systems, while the latter is accepted for linking such systems to the outside world.

MHS has many advocates, Harris says, including X Technologies, Ashton Tate, and Novell, which distributes it with Netware. Workframe's products add functions to MHS systems by letting them do things like automatically forward messages to all members of specific committees, based on a table of addresses. The company is also beta-testing a new version of its XferExec program, which lets users attach instructions to messages which can spawn batch files, DOS commands, or the opening of utility or appli-

cation programs.

X.400, in contrast, "is held out as the end-all, 'the' standard in moving messages," says Harris. Trouble is, "It's still being defined." The biggest problem is addressing the envelope on a message going to another system. That's supposed to be dealt with under X.400 with an enhanced standard called X.500.

Unfortunately, "There are many different naming systems in E-mail. Internet has its own long naming system. MHS is simpler—8 characters plus 8 characters. It's name at host, or name at workgroup." The result is that, while X.400 is an accepted standard, it's seldom used. "If I sell an E-mail system I have to have a link to X.400, but I don't know of anyone using it," Harris says.

Harris told Newsbytes recent discussions on X.500 he's held indicate the problem is not yet solved. "Many protocol issues haven't been decided on. Without a uniform addressing scheme you still have a problem—you either need a look-up table or you have to know an address on a different system."

He concludes, "My impression is without X.500, then X.400 won't provide more than a physical standard. Without an addressing standard you can't move data. And they're saying they're a year from settling disputes, which means we're 2-3 years from X.500 products." Contact: Workframe, 617-491-4678.

Plain-Paper Faxes Via HP Laser Printers

PALO ALTO, CAL., JAN 2 (NB)—Tall Tree Systems has introduced Fax-O-Matic, an external, independent device that receives and prints faxes on a laser

Rossi, DeGroot & Associates

COMPUTER TRAINING

Vancouver's High Quality Training Centre!

- Quality Instructors • Premium Courseware
- PC, VAX & Network Training • Custom Programming
- UNIX System Administration

COURSE SCHEDULE

	FEBRUARY	MARCH
Lotus 123 Level I	Feb. 5, 14, 25	Mar. 6, 12, 27
Lotus 123 Level II	Feb. 11, 28	Mar. 14, 25
Lotus 123 Level III	Feb. 20	Mar. 21
WordPerfect Level I	Feb. 4, 12, 21	Mar. 8, 13, 19
WordPerfect Level II	Feb. 7, 27	Mar. 5, 26
WordPerfect Graphics	Feb. 18	Mar. 22
DOS Level I	Feb. 1, 19	Mar. 1, 20
DOS Advanced	Feb. 22	Mar. 18
Microsoft Word 5 Level I	Feb. 8	Mar. 4
Microsoft Word 5 Level II	Feb. 26	Mar. 28
Multimate Advantage	Feb. 20	Mar. 21
dBase IV Level I	Feb. 13	Mar. 15
Symphony Level I	Feb. 1	Mar. 1
Supercalc IV Level I	Feb. 8	Mar. 4
Harvard Graphics	Feb. 6	Mar. 7
PC Overview	Feb. 15	Mar. 11
SATURDAY SESSIONS		
Lotus 123 Level I	Feb. 16	Mar. 9, 30
WordPerfect Level I	Feb. 2, 23	Mar. 16
DOS Level I	Feb. 9	Mar. 2, 23



Register Now!
683-0020

Located at 650 W. Georgia (Scotia Tower)

Mountainview

data works Phone: 273-2930
Fax: 273 2960

Thousands of Shareware Programs

IBM • APPLE • MAC • COMMODORE • AMIGA • ATARI
From \$3.75

#210-11180 Bridgeport Road
Richmond, B.C. V6X 1T3

1/2 Block East of Shell next to ANO Automation



Professional, Corporate and Educational Leasing and Sales.

Software Sales and Training, including Desktop Publishing and Computer Aided Drafting.

Computer Systems for Graphics and Business by

ATARI®

GXR SYSTEMS, 1250 HOMER STREET, VANCOUVER, BC V6B 2Y5 (604) 687-8527

PowerPay®

The Ultimate Payroll Program

BUSINESS OWNERS! Take advantage of this powerful Canadian payroll program to handle your payroll.

\$89

Learn to Operate in 30 minutes or less!

- Simple Key Strokes
- Menu-driven Selections
- Form Data Entries
- Help Is Just One Key Stroke Away

Flexible

- Chooses pay period and pay method individually for each employee.

Powerful

- Captures pertinent information for summary reports.

System Requirements:
512K memory, DOS 2.0 or higher, hard disk, 5.25" or 3.5" floppy drive, color or monochrome monitor. Runs on IBM and 100% compatibles. Supports all popular printers.

KEY FEATURES:

Pay Periods

- Weekly, Monthly, etc.

Pay Methods

- Monthly Salary, Hourly Pay, Commission Reports

Flexible

- Revenue Canada Remittance

Monthly Employee Summary, etc.

Benefits and Deductions

- Six Benefits (Four Customized)
- Nine Deductions (Six Customized)

Other

- GST Support, etc.
- Advance Cheque Handling
- Posts Data On-line
- T4 Production

* Free customer telephone support

Free! Fully Working Copy of PowerPay® (four-month trial)
(Send \$3.00 for postage and handling. While Quantities Last.)

PowerSoft Systems

3571 Kingsway, Vancouver, B.C. V5R 5L9
Tel: (604) 432-7077 Fax: (604) 432-1655

printer. The device connects directly to Hewlett-Packard II, IIP and III (or compatible) laser printers through the parallel port. A computer is then connected to the device so that both can use the laser printer. A fax machine or fax card can also be connected for transmission of faxes.

Fax-O-Matic provides automatic scaling which allows for legal, A4, and all other large formats to be printed on one 8 1/2 x 11-inch page, the company says. It can store up to 30 pages in an internal 512K buffer when the printer is busy or turned off.

The list price is \$399, and the product is available now directly from the manufacturer. Call 415/493-1980 for more information.

Hayes Wins A Round In Patent Fight

SAN FRANCISCO, CALIFORNIA, JAN 8 (NB)—Hayes Microcomputer Products announced a partial victory in its fight to vindicate its major modem patent, as Prometheus Products agreed to a settlement as the case was due to go to

trial.

Prometheus decided to recognize the Modem with Improved Escape Sequence patent issued to Hayes in 1985, number 4,549,302, and it will pay license fees to Hayes in connection with the execution of its settlement. Trial on the issue continues against two other defendants in the case, but the settlement strengthens Hayes' hands. The 1985 patent covers most PC async modems running at up to 2,400 bits/second. The newest modems are covered by the "V.32" standard agreed to by the CCITT, although both Hayes and US Robotics also sell proprietary products at that speed, called the V-Series and HST Courier respectively. Contact: Hayes, 404-449-8791.

The Gulf War Gulf War Is A Satellite War

Editorial by P. Zucker SYDNEY, AUSTRALIA, JAN 18 (NB) — The Gulf War of '91 may not be remembered for this fact, but it is "The war that happened by satellite." The satellites involved are of two types: military for intelligence and

control, and commercial, for the unprecedented TV coverage of the war.

It was the TV coverage which fascinated this writer. Watching here in Australia, a unique thing happened: there are five TV networks in Australia, and four of them chose to run continuous war coverage, each taking a different U.S. network feed. Anyone turning on Australian TV could be excused for wondering which country they were in.

In addition, the local networks all have reporters in locations such as Saudi Arabia, Baghdad, Jordan, Israel and so on, and each network regularly ran live satellite links to these reporters. Assuming that many other countries (especially European) were doing the same thing, there must have been hundreds of live satellite links every hour, right through the first 12 hours or so of conflict.

Another interesting feature of this TV war (and only a TV war would be timed to start at evening news time in the U.S.) was the "feedback" effect caused by the network's coverage. (Explanation: feedback such as in a public address system where a small sound is fed back into the

system, comes out of the speaker and then back into the microphone - going around getting more distorted and louder as it goes.)

Throughout the first half-day of coverage, it became obvious that the main TV news services (and especially CNN) were being monitored as the best source of news. For instance, people in Saudi Arabia and other parts of the Middle East were monitoring the war from U.S. TV services. A number of times, it seemed that a comment on one service was heard by someone in the Gulf, quickly became a local rumour, was fed to another network as news, broadcast, and then became news on the first network, where it had been just a comment 15 minutes earlier.

\$64 to the person to invent the best name for this phenomenon.

Unix

Maple V Computer Algebra
WATERLOO, ONTARIO, JAN 7 (NB)—Waterloo Maple Software, based here, has begun shipping a new version

GST? No Problem!

Key into four years of New Zealand experience with GST

Logical Methods Limited, one of New Zealand's leading software companies, is opening an office in Vancouver to support its award winning modular accounting system.

PROPHET Accounting for the future

- Accounts Receivable
- Accounts Payable
- Invoicing / Price List
- Point of Sale
- Order Entry / Invoicing
- Sales Analysis
- Purchase Analysis
- Purchase Ordering
- Inventory Control
- Bill of Materials
- Job Costing
- Payroll
- Cashbook
- General Ledger
- Report Generator

Multi-user, integrated, immensely powerful reporting, data recovery from power and hardware failures, tremendous ease of use, comprehensive on-line help, macros, passwords

Software with GST built in, not tacked on.

For more information: In British Columbia, please contact
P.O. Box 151, 916 West Broadway, Vancouver, V5Z 1K7
(604) 879 0204 (24 hours) FAX (604) 929 8242

Please tell me more about the PROPHET System
Name: _____ Company: _____
Phone: _____ Fax: _____
Address: _____

02-02-91

*Why don't you call
Compatible Computers, John?*

Computer Problems?



For \$75, we will:

- Clean computer and keyboard
- Clean all contacts and treat for corrosion
- Clean floppy and micro-floppy drives
- Check and/or replace batteries
- Check RAM with diagnostic program
- Scan hard disk for virus programs
- Backup hard disk drive and re-low level format
- Check for device conflicts
- Loop back check of all serial and parallel ports
- Optimize all components for full performance
- Label all connectors (printer, mouse, video, etc.)
- Make recommendations for future upgrades
- Complete report on system

We also service "dead" computers

- Free estimates!
- Repairs to all IBM and compatible makes & models
- 90-day repair guarantee

COMPATIBLE
COMPUTERS INC.
5487 KINGSWAY, BURNABY, B.C. V5H 2G1
(604) 435-5400

of Maple, its computer-based algebra system. Maple V is available initially on Sun 3 and SPARC-based workstations, most Digital Equipment systems running Ultrix, and Unix systems from MIPS Computer Systems, said Janet Cater, marketing manager.

Cater said the company plans to release Maple V for Apple Macintosh and Intel 386-based systems in the first quarter of 1991, and for all other systems that run previous versions of Maple later in the year. Maple runs on an assortment of hardware from microcomputers to supercomputers, she told Newsbytes.

Maple runs on a variety of Unix-based hardware, according to the company. Waterloo Maple chose the Sun platform for the first release of Maple V because "it addresses one of Maple's largest customer bases," said Ron Neumann, chief executive of the company, in a prepared statement.

Maple V for Sun sells for US\$2,495, with equivalent pricing in other currencies around the world. The Ultrix versions range from US\$695 to US\$3,595, depending on hardware supported. Site licenses and academic discounts are available. Contact: Waterloo Maple Software, 519-747-2373.

AT&T Buys More Sun Stock

MOUNTAIN VIEW, CAL., JAN 8 (NB)—Sun Microsystems says it will sell AT&T another 491,755 shares of newly issued stock, all but concluding a two-year-old agreement to sell AT&T as much as 20 percent of the company.

Austin Mayer, a spokesman in Sun's Investor Relations department, said that the agreement let AT&T buy as much as 15 percent of Sun (14.8 million shares) in newly issued shares directly from the company, plus another 5 percent on the open market. Mayer said he believed that AT&T has bought most of the stock to which it is entitled from the market. The latest block of shares from Sun is the last to which AT&T is entitled.

Sun expects the sale to be consummated within 30 days. The price will be based on the average closing price of Sun stock for the 20 trading days ending January 3, plus a 25 percent premium.

Despite AT&T's large holding in Sun, it does not have a seat on the company's board of directors. AT&T gave up its seat when it became apparent that Sun and AT&T would be competing in the hardware arena and not just cooperating on Unix software. Contact: Sun Microsystems, 415-336-6255.

Windows

Lotus To Bundle Ami Pro With 1-2-3 V. 3.1

CAMBRIDGE, MASS., JAN 8 (NB)—In a dual endorsement of Microsoft Windows, Lotus Development has announced it will give a free Windows-based word processor to buyers of Lotus 1-2-3 3.1, and has guaranteed an upgrade price that will let buyers of 1-2-3 3.1 move to an expected Windows version of 1-2-3.

Lotus will give a free copy of Ami Professional, the Windows word processing software from recently acquired Samna, to buyers of 1-2-3 Release 3.1. Lotus acquired Samna, of Atlanta, in November for about US\$65 million. The offer is valid in the United States

and Canada on 1-2-3 3.1 purchases and upgrades between January 8 and April 30. The suggested retail price for 1-2-3 Release 3.1 is US\$595 or C\$719, with upgrades priced at US\$150 or C\$185. Ami Pro carries a suggested retail price of US\$495 or C\$599.

To receive their free Ami Pro, most 1-2-3 3.1 buyers will have to send their original sales receipts to Lotus as proof of purchase, along with an Ami Pro coupon available through local and national advertising, from Lotus-authorized resellers or by calling Lotus (at 1-800-TRADE-UP in the United States or at 1-800-668-1509 in Canada). Users must include a US\$19.95 (C\$25) shipping and

handling charge if ordering directly from Lotus.

Lotus also announced a Technology Guarantee upgrade program under which new 1-2-3 Release 3.1 buyers can upgrade to a future version of 1-2-3 for US\$49 in the United States or C\$59 in Canada.

To take advantage of the Technology Guarantee program, users must purchase or upgrade to 1-2-3 Release 3.1 on or after Jan. 8, 1991.

Contact: Lotus Development, 617-693-1292.

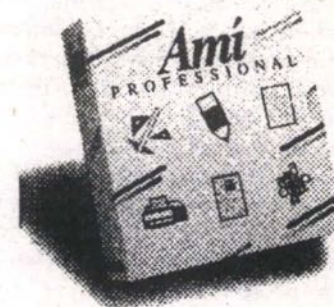

InfoSpec Systems Inc.

#101 - 2806 Kingsway, Vancouver, B.C. V5R 5T5
Tel: (604) 430-1223 Fax: (604) 430-5748
Business Hr. : Monday - Friday 9:30 - 6:00
Saturday 1:00 - 6:00

Your One Stop Business Solution

PROFITEK SYSTEMS

- Profitek - RS Retail Sales System
- Profitek - RM Restaurant Management System
- Profitek - VM Video Management System
- Profitek - EB EasyBill Medical System
- Profitek Integrated Accounting Systems

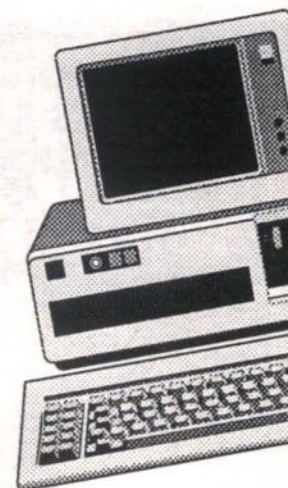
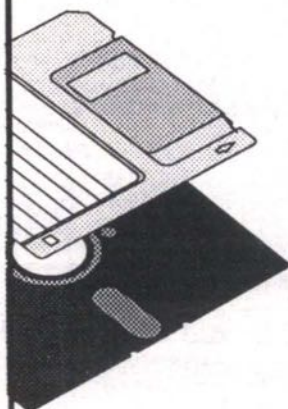

Smart buyers shop for **QUALITY & SERVICE**. At InfoSpec Systems, we provide powerful, flexible, yet affordable solutions to various businesses and industries. Being 5 years in business, you can depend on our expertise and experience.

We specialize in:

- Point-of-Sale
- Inventory Control
- Accounting, Payroll
- Hardware Selection
- Novell Network
- Installation & Training
- Support & Maintenance

Carbon Copy Plus V5.22	\$147.99
Direct Access V5.0	\$ 77.99
Lotus 1-2-3 V2.2	\$389.99
PC Tools Deluxe V6	\$ 97.99
Quicken 4.0	\$ 44.99
Suzy	\$ 18.99
Word Prefect 5.1	\$279.99
Windows 3.0	\$ 89.99

Logitech 3-Button Hi-Rez Mouse & Windows 3.0	\$159.99
----------------------------------------------	----------

80286-12 VGA Colour System

- 1MB RAM, 1.2MB 5 1/4" Floppy Drive
- Miniscribe 40MB 28ms Voice Coil Hard Disk **
- 14" VGA Colour Monitor 640x480 .41mm

\$1,199

80386SX-16 VGA Colour System

- 1MB RAM, 1.2MB 5 1/4" Floppy Drive
- Miniscribe 40MB 28ms Voice Coil Hard Disk **
- 14" VGA Colour Monitor 640x480 .31mm
- 19" Tower Case with Digital Display

\$1,799

80386DX-25 Super VGA Colour System

- 1MB RAM, 1.2MB 5 1/4" Floppy Drive
- Maxtor 80MB 17ms Voice Coil Hard Disk **
- 14" VGA Colour Monitor 1024x768 .28mm **
- 16 Bit 512K VGA Graphics Card

\$2,399

Laptops on Sale

- Bondwell 286-12 w/ 1MB RAM 40MB HD, Battery ,7lbs
- Mitsubishi 286-12 w/ 640K RAM 40MB HD, CGA/EGA
- Daewoo 386SX -16 w/ 1MB RAM 40MB HD, VGA, Battery
- Intra LT386SX-16 w/ 2MB RAM 40MB HD, VGA, Battery

Authorized Dealer of:



Lotus



* Prices & specifications subject to change & while quantities last

** Two years parts/labour warranty on items marked

Fax Software For Windows

TORONTO, ONTARIO, JAN 17 (NB) — Software developer Delrina Technologies here said its Winfax fax software will let Microsoft Windows 3.0 users send faxes directly from within any Windows applications, including Delrina's own Perform Pro forms processor.

The software works with any PC fax card using the Sierra Semiconductor Sendfax chip set. That accounts for about half the fax cards on the market, Delrina spokesman Josef Zancowicz told Newsbytes. Among the cards the software supports are those from Zoom Telephonics, Cardinal Technologies,

Cycad, Xecom, Ven-Tel, Prometheus, Practical Peripherals, and CPI. Intel, however, uses a different standard.

Winfax users can send faxes by selecting the print command from the menu in a Windows 3.0 application. Output data and fonts are matched to the resolution of a Group III fax machine, Delrina said.

The suggested retail price of the software is US\$69. Zancowicz said Delrina is working on deals to bundle the software with fax cards from various manufacturers, as well as sell it through major software distributors.

Delrina also announced a limited-time price promotion on PerForm 2.1, its

entry-level forms software. Effective January 1, the price of PerForm 2.1 is reduced to US\$149. Zancowicz said the promotion is initially scheduled for six months, but might be extended. Response has been good so far, he said. Contact: Delrina Technologies, 416-441-3676.

Wordstar For Windows 3.0 Due

LONDON, ENGLAND, JAN 17 (NB) — Wordstar International has called a press conference for Tuesday, January 22. The company will launch a version of its Wordstar word processing package for the Microsoft Windows 3.0

COMPUTER SWAP-MEET

YOU JUST CAN'T BUY IT FOR LESS

- 75 Exhibitors
- Door Prizes
- Computers
- Software
- Printers
- Modems
- RAM
- Mice
- Drives
- Monitors
- Free Parking
- Concessions

For More Information Call 531-0829

THE MALL THAT HAS IT ALL

SATURDAY FEBRUARY 16TH

10 AM - 4 PM

**McPherson Convention Centre
7325 MacPherson Ave., Burnaby, B.C.**

NewViews ACCOUNTING

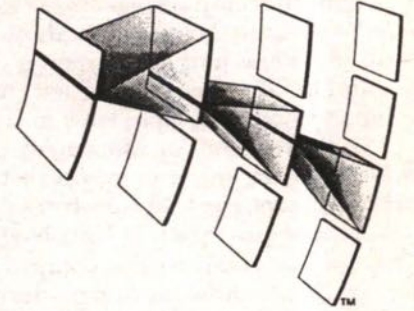

The Visual Approach to Accounting

SALES

SUPPORT

TRAINING

Certified Consultants

CompuWork Pacific Inc.
Vancouver, B.C.
684-8211

Attention Software Publishers

Have your Software Professionally Beta Tested or Evaluated.

65% Canadian Government Grant available.

For more information.

Call
ISR Software Review Corp.



The number one professional software testing & evaluation company in Canada.

(604)538-0517

13708 20TH Avenue
South Surrey, B.C.
V4A 1Z7

MORSE-TECH COMMUNICATIONS

80286-12/16 SYSTEMS

- Intel 80286-12/16 MHz CPU; AMI Bios 12 MHz \$ 895
- expandable to 4 MB on system board
- Headland Chipset; 6 expansion slot 16 MHz \$ 935
- Intel 80287-10 math coprocessor socket
- Maxtor 40MB voice coil HD w/ 28ms, 32K cache

80386SX-16/20 SYSTEMS

- Intel 80386SX-16/20 MHz CPU; AMI Bios 16 MHz \$ 1325
- expandable to 8 MB on system board
- Intel 80387SX-16 math coprocessor socket 20 MHz \$ 1445
- eight expansion slots
- Maxtor 40MB voice coil HD w/ 28ms, 32K cache

80386DX-25 SYSTEM

- True Intel 80386DX-25 MHz CPU; AMI Bios
- expandable to 8 MB on system board
- 386 OPTI Chipset
- math-co socket for 80387DX-25/Weitek 3167
- Maxtor 40 MB voice coil HD w/ 28 ms, 32K cache

\$1595

80386DX-25 CACHE

- Intel 80386DX-25 MHz CPU; AMI Bios
- 64 KB Cache memory; OPTI Cache controller
- OPTI Chipset @ 25MHz
- expandable to 8 MB on system board
- math-co socket for 80386DX-25
- Maxtor 40 MB voice coil HD w/ 28 ms, 32K cache

\$1795

Standard Features for 286/386 Systems:

- 1 MB RAM (80 ns)
- Teac 5.25" 1.2 MB or 3.5" 1.44 MB FD
- Maxtor 40 MB HD
- 1:1 interleave 16-bit IDE host adapter
- AT I/O w/ 1 serial, 1 parallel, 1 game ports
- Hercules compatible monochrome graphics card
- 12" amber monochrome TTL monitor
- desktop case with 200 Watt CSA approved power supply
- 101-keys enhanced tactile click keyboard

Maxtor 40 MB HD have 2-yr warranty

80386DX-33 CACHE

- True Intel 80386DX-33 MHz CPU
- 64 KB Cache memory; 128 KB optional
- OPTI Cache Controller; OPTI Chipset
- expandable to 32 MB on system board
- math-co socket for 387DX-33 or Weitek 3167
- eight expansion slots
- Maxtor 40 MB voice coil HD w/ 28 ms, 32K cache

\$1895

ALL DESKTOP SYSTEMS COMES WITH 2-YR LABOUR 1-YR PARTS WARRANTY

Prices may change without notice.

Introducing Our Latest Pride: INTRA LT-386SX LAPTOP

- Intel 80386SX-16 MHz CPU
- 2 MB RAM exp. to 6 MB using standard SIMM
- 3.5" 1.44 MB FD
- 40 MB 3.5" HD
- parallel, serial, ext VGA, ext FD, keyboard ports
- internal slot for modem/Fax board
- 85/86 keys w/ 12F keys/ embedded numeric keys
- LCD display w/ 16 gray scales, 640x480, .27 dp
- detachable Ni-Cad battery provides up to 3 Hrs of uninterrupted use and battery low warning.
- AC/DC converter operating from 100-240 V
- dimensions: 1.28" x 12.4" x 2.36"
- weighs 10.9 lbs with battery
- MS DOS 4.01 w/ GW-Basic
- carrying case
- one year warranty

\$ 3595

Ultimate Power User's Dream Machine i486-25 Computer System

- Intel i486-25 MHz CPU w/ 8 KB internal cache
- built-in math coprocessor
- 128 KB external cache memory
- socket for Weitek 4167 math coprocessor
- 4 MB RAM (80 ns) exp to 16 MB on system board
- Teac 5.25" 1.2 MB or 3.5" 1.44 MB floppy drive
- Rodime 110 MB (18 ms) IDE voice coil hard drive
- 16-bit 1:1 interleave HD/FD host adapter
- six 16-bit, two 8-bit slots; 2 ser, 1 par, 1 game ports
- 101-keys enhanced tactile click keyboard
- Full Size case w/ 220 W CSA app. power supply
- Paradise VGA card 512 KB (OEM, 1024x768)
- Morse 14" VGAPlus monitor (1024x768, .28mm)

come see our i486 demo with Seiko mon/Tricom

\$ 3995

SYSTEM UPGRADES: (Add to above 286/386 desktop system price)

- Teac 3.5" 1.44 MB or 5.25" 1.2 MB floppy drive \$ 85
- Mitsubishi 60 MB (28 ms) voice coil hard drive (RLL) upgrade \$ 110
- Maxtor 84 MB (19 ms) IDE voice coil hard drive upgrade \$ 235
- Rodime 110 MB (19 ms) IDE voice coil hard drive upgrade \$ 325
- second serial chipset \$ 8
- AOC 12" paperwhite VGA monochrome monitor w/ OAK VGA card 256K \$ 99
- GoldStar 1430 14" colour VGA monitor (640x480, .31dp) w/ OAK VGA card 256K \$ 335
- Legend 14" (1024x768, .28dp) colour VGA monitor w/ Paradise VGA OEM 256K exp 512K \$ 395
- Morse 14" (1024x768, .28 dp) colour VGA monitor w/ Paradise VGA OEM 256K exp 512K \$ 470
- Seiko 1440 (1024x768, .25 dp) multisync monitor w/ Paradise VGA OEM 256K exp 512K \$ 750
- NEC 3D (1024x768, .28 dp) multisync monitor w/ Paradise VGA OEM 256K exp 512K \$ 950
- Upgrade to Tricom Mega/1024 1 MB VGA for packages w/ Paradise VGA OEM \$ 65
- Video Memory upgrade to 512K from 256K using 4464 DRAM \$ 24
- Video Memory upgrade to 512K from 256K using 44256 DRAM \$ 18
- Each 1 MB RAM upgrade (using 80 ns 256K DRAM or SIMM) \$ 89
- Eaxh 1 MB RAM upgrade (using 80 ns 1 MB DRAM or SIMM) \$ 79

TVM Supersync 2A Bundle with OEM ATI VGA Edge16

800x600, .31 mm dp, 256K **\$ 625**

TVM Supersync 3A Bundle with OEM ATI VGA Wonder

1024x768, .28 mm dp, 256K **\$ 699**

TVM Supersync 5A monitor 15" non-interlaced flatscreen

1024x768, .28 mm dp **\$ 749**

Video Adapters & Monitor:

- monochrome graphics card \$ 25
- Trident 16-bit VGA card 1024x768, 256K exp to 1MB \$ 115
- OAK 16-bit VGA card (800x600) 256K \$ 79
- Paradise OEM VGA card 1024x768 256K exp to 512K \$ 115
- ATI VGA Wonder + OEM card 1024x768 256K exp to 512K \$ 209
- Tricom Mega/1024 VGA 1MB 1024x768 256 colours \$ 185
- 12" TTL amber monitor \$ 105
- AOC 12" Paperwhite VGA monitor \$ 120
- MiniMicro 14" paperwhite VGA monitor \$ 150
- GoldStar 1405 paperwhite VGA monitor (800x600) \$ 195
- GoldStar 14" colour VGA monitor 31 mm dp \$ 375
- Legend 14" Multiscan VGA colour monitor 1024x768 .28 dp \$ 395
- Morse 14" Multiscan VGA colour monitor 1024x768 .28 dp \$ 469
- TVM Supersync 2A w/ ATI OEM VGA Edge16 Bundle \$ 625
- TVM Supersync 3A w/ ATI OEM VGA Wonder Bundle \$ 699
- TVM 5A 15" non-interlaced flat-screen monitor, 1024x768 \$ 749
- Seiko 1440 14" Multisync monitor 1024x768 .25 dp \$ 695
- Seiko 1450 14" Multisync monitor 1024x768 .25 dp \$ 875
- NEC Multisync 3D monitor 1024x768, .28 dp \$ 950

Mice:

- Logitech Hi-res serial mouse \$ 79
- Logitech Hi-res bus mouse \$ 89
- Logitech Hi-res serial mouse w/ Windows 3.0 \$ 159
- Logitech serial Trackman \$ 119
- Microsoft Hi-res serial or bus mouse w/ paintbrush \$ 125
- Microsoft Hi-res serial or bus mouse w/ Windows 3.0 \$ 185
- IMSI serial mouse w/ Pipedream, Magician, TurboCad \$ 69
- Dexxa serial mouse (by Logitech) w/ mouse pad & Paint \$ 35
- Everdata Super Mouse II w/ mouse pad \$

Hard Drives:

- Maxtor 8051A 40 MB (28ms) voice coil IDE w/ 16-bit host adapter; 32K cache, 2-yr warranty \$ 325
- Mitsubishi MR535 (28ms) 40MB MFM, 62MB RLL w/ 16-bit RLL 1:1 controller \$ 435
- Maxtor 84 MB (19ms) voice coil IDE w/ 32K cache w/ 16-bit host adapter \$ 560
- Rodime 110 MB (19ms) voice coil IDE 64K cache w/ 16-bit host adapter \$ 650
- Rodime 200 MB voice coil IDE (19ms) w/ 64K cache w/ 16-bit host adapter \$ 1050
- Maxtor LXT200A 200 MB (15ms) voice coil IDE w/ 16-bit host adapter \$ 995

Hard Drive Controllers:

- 16-bit IDE host adapter HD/FD \$ 27
- Kimpson 16-bit 1:1 RLL HD/FD controller \$ 99
- Kimpson 16-bit 1:1 MFM HD/FD controller \$ 85

Miscellaneous:

- SoundBlaster \$ 205
- Gravis analog joystick \$ 45
- Y-cable for gravis joystick \$ 12
- Tape Drives: \$ 370
- Colorado Jumbo 120, 40-120 MB capacity w/ one tape \$ 75
- Colorado AB10 tape adapter (2.2 MB/min.) for Jumbo 120,250 \$ 449
- Colorado Jumbo 250, 120-250 MB capacity w/ one tape \$ 449
- Colorado FC10 tape adapter (4.4 MB/min.) for Jumbo 250 \$ 110
- Colorado TC15 tape adapter (8.8 MB/min.) for Jumbo 250 \$ 250
- External kit for Jumbo 120, 250 \$ 140
- 3M DC2000 40 MB tape for Jumbo 120 \$ 35
- 3m DC2120 60/120 MB tape cartridge for Jumbo 120, 250 \$ 42

Printers (6' printer cable incl.):

- Raven 9101 9-pin printer 192cps draft 38cps NLQ \$ 235
- Raven 2417 24-pin printer 192cps draft 63cps LQ \$ 415
- Fujitsu DL1100 24-pin printer 240cps draft 60cps LQ \$ 415
- Colour option kit for Fujitsu DL1100 \$ 69
- Fujitsu DL3400 24-pin printer 240cps draft 60cps LQ \$ 465
- Colour option kit for Fujitsu DL3400 \$ 100
- Star NX1001 9-pin printer 180cps draft 45cps NLQ \$ 220
- Star NX1020 Rainbow 9-pin color printer \$ 295
- Star NX2410 24-pin printer 180cps draft 60cps LQ \$ 339
- Hewlett Packard DeskJet 500, 3 ppm, 300 dpi \$ 995
- Hewlett Packard LaserJet IIP, 4 ppm, 300 dpi, 512K \$ 1350
- Hewlett Packard LaserJet III, 8 ppm, 300 dpi, 1 MB \$ 2195

Math Coprocessor:

- AMD 287-10 \$ 175
- Cyrix 387SX-16 \$ 345
- Cyrix 387DX-25 \$ 530
- Cyrix 387DX-33 \$ 630
- Intel 80287-10 \$ 295
- Intel 80387SX-16 \$ 395
- Intel 80387DX-20 \$ 495
- Intel 80387DX-25 \$ 610
- Intel 80387DX-33 \$ 725

Modems:

- Cardinal 2400 bps internal modem w/ Bitcom \$ 98
- Cardinal 2400 bps internal modem w/ software MNP5 \$ 115
- Cardinal 2400 bps external modem w/ software MNP5 \$ 155
- Cardinal 2400 bps internal modem w/ hardware MNP5 \$ 169
- Cardinal 2400 bps external modem w/ hardware MNP5 \$ 239
- Cardinal 9600 bps internal modem \$ 649
- Cardinal 9600 bps External modem \$ 795

Legend MultiScan VGA Bundle with OEM Paradise VGA1024

1024x768, .28 mm dp, 256K **\$ 525**

Windows 3.0 driver available

Software:

- WordPerfect 5.1 \$ 295
- LetterPerfect \$ 165
- Lotus 123 V2.2 \$ 399
- Lotus 123 V3.1 \$ 529
- Lotus Works \$ 69
- Microsoft DOS 4.01 w/ GW Basic \$ 79
- Microsoft Works V2.0 \$ 129
- Microsoft Windows 3.0 \$ 109
- Microsoft Productivity Pack for Windows \$ 59
- Microsoft Entertainment Pack for Windows \$ 36
- Microsoft Word 5.5 \$ 269
- Microsoft Word for Windows \$ 325
- Microsoft Excel \$ 345
- Norton Utilities V5.0 \$ 135
- Norton Backup \$ 145
- PCTools Deluxe V6.0 \$ 99
- Quarterdeck 386 Expanded Memory Manager \$ 89
- Quarterdeck Desqview 386 \$ 179
- Aldus Pagemaker \$ 589
- ACCPAC Bedford Integrated Accounting \$ 145
- CorelDraw V2.0 \$ 539

MORSE-TECH COMMUNICATIONS

1237 WEST BROADWAY VANCOUVER, BC V6H 1G7

Tel: 738-3886 Fax: 738-2881

Mon-Fri: 9:30am-6:00pm Sat: 10:00am-5:00pm

Sunday CLOSED

Lotus

Authorized Reseller

CANTEL

Atari Portfolio

w/ AC adapter & batteries, card drive, 2-64K mem card, MS DOS compatible

Amazing Price

\$ 299, 1 only

- Group Purchase Pricing is available.
 - Talk to our representative about Leasing options.
 - Free Consultations.
 - extended warranty available - call for details
- "We are here to Help You !"

SPREADSHEETS

Spreadsheets

by Graeme Bennett

Spreadsheets have traditionally been used to add up lists of numbers, balance books, and solve equations. They are powerful tools if you know how to use them, and go far beyond simple number crunching.

Many of today's spreadsheets exploit the graphics capabilities of the machine to generate amazing graphs. Wingz (for Mac, Windows, NeXT and Unix) and Excel

(especially version 3.0, just released for Windows) both take this to the extreme. You want to draw a 3-D stacked bar graph and view it from above and behind? You can. Want to draw a 3-D pie chart with thousands of slices? You can.

By combining the spreadsheet and graphs on the same screen, you can do things like have your monthly totals on one line, and a graph of that data right below it. With database capabilities and macros, it is possible to customize a spreadsheet to look like almost anything: a tax form, a calendar, a database, you name it. You can even build dialog boxes right into

spreadsheets so anyone can use it. With Lotus announcing a Windows-based version of 1-2-3, and companies like Borland putting their hats in the ring with products like Quattro and Quattro Pro, this area will have a lot of competition for years to come. (Interestingly, Lotus recently won a lawsuit against Paperback Software for their VP Planner spreadsheet's resemblance to 1-2-3. Wouldn't it be ironic if Microsoft successfully sued Lotus for "look and feel" similarities to Excel, now that the two programs share Microsoft's Graphic User Interface?)

Excel 3.0

Spreadsheet Heavyweight—Worth The Wait?

by Graeme Bennett

In the left corner: the current heavyweight champion of the spreadsheet world...Lord Lotus! And challenging from the right corner, the Mighty One, Microsoft..

Product: Excel 3.0

Publisher: Microsoft, One Microsoft Way, Redmond WA 98052-6399; 800/426-9400

System Requirements: (PC Version) 286, 386SX/DX or 486-based PC compatible computer, at least one megabyte of conventional memory, Microsoft Windows 3.0 or later. (Macintosh and OS/2 versions available soon—contact Microsoft for details)

Price: US\$495, upgrades \$129.

Key Features:

- Tool bar provides quick access to commonly used functions and commands
- Outliner aids creation of hierarchical spreadsheets
- Consolidation of multiple worksheets
- Enhanced drawing tools, text annotations and graphing abilities
- 1-2-3 help and compatibility features

Super Bundle!

Good Things Come In GREAT Packages.



CTX

- ✓ **Multi Scanning** MC5468
28—38KHz Horizontal
50—90Hz Vertical
Provides Maximum Screen Display
- ✓ **Super Fine CRT**
0.28mm Dot Pitch
- ✓ **1024 X 768 Interlaced**
- ✓ **Universal Power Supply**
90—260 VAC Auto Sensing
- ✓ **Front Panel Adjustment**
For Screen Display

Bundled together for great price and superior performance!

Available exclusively from

COMTEX

Head Office
Unit #100 - 13751 Mayfield Place,
Richmond, BC, Canada V6V 2G9
Tel: (604) 273-8088
Fax: (604) 278-2818
Toll-free Fax: 1-800-633-0291

Calgary Warehouse:
Bay #7—3610 - 29th Street N.E.
Tel: (403) 250-3386
Fax: (403) 250-8092



Plus
Genoa
SYSTEMS CORPORATION

- ✓ **70Hz Super VGA**
Flicker Free
- ✓ **1024 X 768 Resolution**
- ✓ **Maximum Compatibility**
- ✓ **Supports Windows™ 3.0**
In High-Res Mode



Even people who don't know spreadsheets from bedsheets have probably heard of Lotus 1-2-3. Rarely does a product catalyze the interest of the computer world like it did the PC market back in the early '80s (1983, to be exact). Then—as now—business PC users everywhere found 1-2-3 a truly useful tool for financial calculations, analysis and forecasting.

Although not the first computerized spreadsheet (VisiCalc, I believe, has that distinction), 1-2-3 dramatically improved on the powers of its predecessor, adding graphing and database functions to its VisiCalc-like spreadsheet functions.

Like any superstar, 1-2-3 soon spawned an entire genre of me-too clones, for virtually all types of computers. The usual approach was to approximate the Lotus look and feel (which, as Paperback Software can tell you, sometimes leads to trouble!), and offer 1-2-3 file import and export abilities.

Back in its Sept. 1985 issue, *MacWorld* magazine first previewed a (then-prerelease) version of a next-generation spreadsheet for the Mac called Excel, and compared it to Jazz, Lotus' (now abortive) entry into that market. As history has shown, Microsoft Excel ended up with almost 90% of the Mac spread-

Budget Conscious Speed Demons

Introducing the IPC-286/20.
20 Megahertz Speed
at an Unbeatable Price.

If you're like most computer users, you simply don't need the awesome processing power of 386 and 486 machines. What you do need is awesome processing speed at a price that fits your budget. Our engineers had that in mind when they designed the new IPC-286/20.

At 20MHz the IPC-286/20 is certainly fast enough for just about any ordinary application. Word processing, desktop databases, normal spreadsheets and simple graphics are all handled promptly and efficiently. And as a network node it neatly outperforms more powerful machines running at slower speeds.

The IPC-286/20 is fully test compatible with MS/DOS, Unix, Novell, OS/2, and all your current ISA based application software. It comes standard with a quality 40MB hard disk drive, a VGA graphics card, and a high resolution VGA compatible monitor.

We've used gate array design and top quality components including a Harris C.P.U. to ensure 100% satisfaction. Naturally, our comprehensive IPC 3&1 Warranty applies and cross Canada on-site service is provided.

So call your nearest 3D Microcomputers stocking location for the name of your local IPC dealer. Now you can have all the speed without blowing all your budget.

3D MICROCOMPUTERS

Vancouver

(604) 873-5595
Fax: 873-4552

Edmonton

(403) 484-0151
Fax: 484-0180

Toronto

(416) 494-5250
Fax: 494 5504

Kingston

(613) 384-8980
Fax: 384-8981

Calgary

(403) 250-2590
Fax: 250-3059

Winnipeg

(204) 772-9028
Fax: 772-9034

Montréal

(514) 659-6522
Fax: 659-8109



IPC-286/20

Microprocessor	80286
Operating Speed	20 MHz
Hard Drive	40 MB
Floppy Drive	1.2 MB
RAM	1 MB
Video Card	VGA
Monitor	14" VGA
Expansion Slots	six 16 bit
Drive Bays	3 half height, one 3.5 inch

\$1295.00

Suggested Retail Price

sheet market.

Not long after that (late '86 or so), Microsoft's Windows environment for the PC brought the first cut of a Windows-based Excel. Excel for Windows was unusual for its time, because it required the newer—and then costly—286-based PC/AT.

Even from its earliest incarnations, Excel was favored over Lotus for ease-of-use, more sophisticated graphics and numerous print and display options. But still 1-2-3 held the fascination and purse-strings of spreadsheet users, retaining a vast lead in product sales. Many saw the success or failure of Excel as inextricably tied to that of Windows itself—in ver-

sions 1 and 2, not exactly a runaway success.

Each program has grown in size, power and version numbers. Today, Lotus 1-2-3 is at version 3.1 and Microsoft has released Excel 3.0. Now Microsoft, with the stunning popularity of Windows 3.0, has brought much of the Mac's look and feel to the realm of MS-DOS. Is history set to repeat itself in the PC world?

And The Winner Is...

Rather than keep you in suspense, I'll tell you now: there is no clear winner. 1-2-3 is still ahead in spreadsheet-publishing power and provides more facilities to construct and manage modular spread-

sheets (important for power users), but Excel has a far more usable spreadsheet interface and superior graphical object handling.

This probably means that Microsoft's best chance at eventual market dominance is from the ground up, starting with those people who will prize Excel for its ease-of-use. If it can sway 1-2-3 users over, all the better. As we shall see, both strategies are evident in Excel 3.0's design....

More Ease, Please

To their credit, Microsoft has not just piled on a new batch of esoteric features (although there are plenty), but has in-

stead taken the tack of trying to simplify the most common spreadsheet tasks, thus considerably enhancing the program's ease-of-use.

Users of the current Excel version will notice several enhancements to the display, most notably a *Word-for-Windows*-like tool bar across the top of the screen where common commands and features have been distilled into a row of buttons. Functions for calculating the sum of a column of numbers, setting column alignments, creating various graphics objects and more are available at the click of a button in the tool bar.

1-2-3-4

Excel makes the upgrade path for 1-2-3 users easy, with a dialog box that describes and executes the Excel equivalents of 1-2-3 commands. 3.0 can load 1-2-3 WK3 files and macros.

Other supported formats include dBASE IV, text (DOS or Macintosh formats), templates and CSV (comma separated value) files, as well as files created with earlier versions of Excel.

It can also create external references to 1-2-3 Release 2.x and Release 3 worksheets (although only to the first layer of a Release 3 document). These external references look exactly like external references between two Excel documents.

Q+E, Pioneer Software's SQL database query utility is also included, for true relational database capabilities.

Macros & Outlining

Version 3.0 can auto-execute macros when the program is started and add-in macros are also available that make custom functions and commands available to users without giving them access to the macro sheet itself. Custom dialog boxes are also possible.

An outline function is available to automatically organize worksheet data in up to seven hierarchical levels, allowing data to be indented or demoted to define relationships. Once constructed, details of an outline can be collapsed with a single mouse click to see the "Big Picture."

NewWave

Excel 3.0 takes advantage of services made available by HP's NewWave operating environment, allowing Excel objects to be created and linked to documents in other NewWave-aware applications.

Solve This

Excel 3.0 includes two forms of sophisticated goal-seeking capabilities, in the form of a built-in command and a separate, more advanced utility program called Solver. The first, the Formula Goal Seek command, finds a value that returns a desired result in a formula. For example, you might use it if you wanted to find out how many units of a particular product you have to sell to push your total sales above 10,000 units.

The other, more complex, "what-if" analysis, Excel's Solver, provides more flexibility and power in specifying the constraints for the value you are seeking. An example given in the excellent Excel documentation poses a situation where you'd like to find out what level of advertising spending across a four-quarter period would produce the optimum

CONTINUED ON PAGE 54

The Apple® Classic™ Is Once Again Arriving In Early February!

If you missed out on an Apple® Classic™ in 1990, you will be very pleased to know that a large shipment of Classics will be arriving at Byte Computers, the first week of February.

Don't delay! Come in and see one of our experienced sales staff and put your name on the list for a Classic™.

Remember, *the first week of February.*

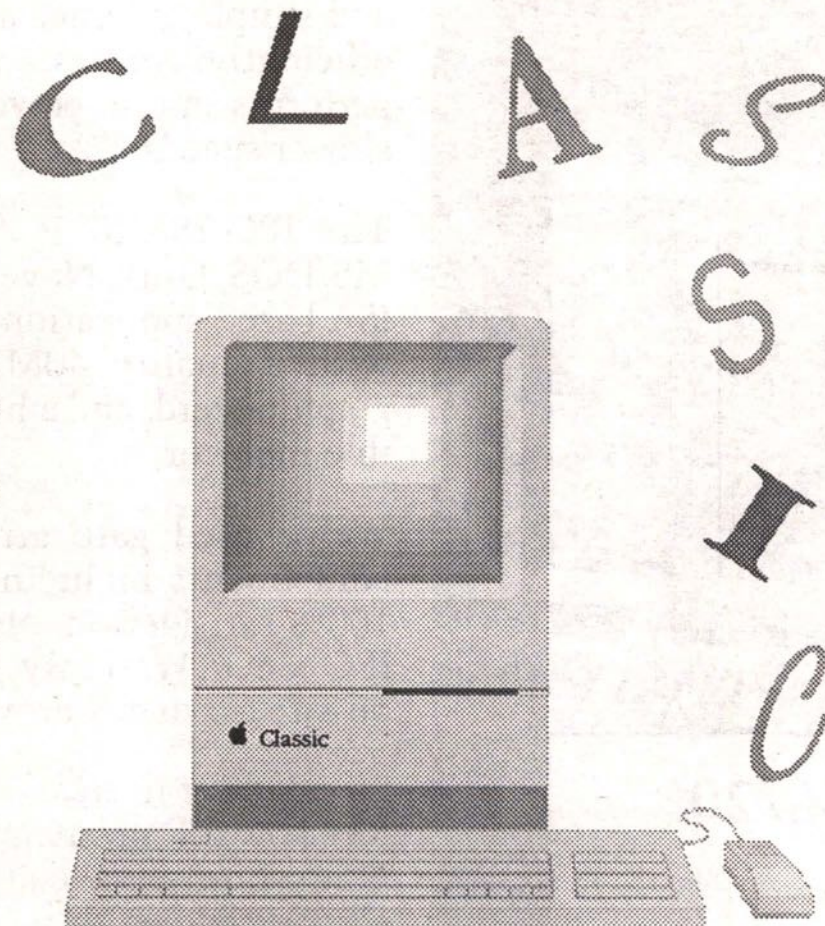

Authorized Dealer

©1989 Apple Computer, Inc. Apple, the Apple logo, and Macintosh are registered trademarks of Apple Computer, Inc. Classic is a trademark used under license.

BYTE COMPUTERS

2151 Burrard St.
Vancouver, B.C.
738-2181

2001A Douglas St.
Victoria, B.C.
383-4485

SPREADSHEETS

Lotus 1-2-3 Release 3.1

by Steve McIlwain

Overview

Lotus 1-2-3 Release 3.1 combines standard spreadsheet structure with printing and page layout tools, and drawing tools. An optional graphical interface is available for machines that can handle it.

Setup and Ease of Use

Lotus 1-2-3 installs from a simple menu-driven installation program. This program installs the software and sets up the printer drivers and fonts. Lotus 1-2-3 comes with Bitstream fonts, which are created at the time of installation. This is the easiest implementation of Bitstream I have yet to see.

Release 3.1 still has the same interface as Release 3. Although the implementation is very clean and looks quite nice on a graphics display, I wonder when Lotus will update their user interface to the current standards.

Mouse compatibility has been added in the WYSIWYG interface and is a welcome addition, but most users will find the WYSIWYG interface too slow. Mouse compatibility should be added to the standard interface.

The WYSIWYG interface is an add-in process which is included with this release. This provides a very simple, easy-to-use interface, but it is slow. I made many mistakes while using this interface due to the fact that the display was far behind where I was in my data entry. I thought I was someplace on the spreadsheet when in fact I was in a different cell.

As with Windows 3.0, you give up too

Product: Lotus 1-2-3 Release 3.1 Advanced 3-D spreadsheet in an interactive graphical environment.

Publisher: Lotus Development Corporation, 55 Cambridge Parkway, Cambridge, Mass. 02142.

System Requirements: IBM PC-AT or Lotus certified compatible, hard disk with 5MB available, EGA, VGA, high-resolution CGA or Hercules graphics adapter for WYSIWYG display, 1MB of RAM, DOS 3.0 or higher.
Price: C\$719.

Key Features

- Optional WYSIWYG interface
- Mouse support in the WYSIWYG interface
- Advanced file linking
- Live on-screen formatting
- Bitstream fonts
- Graphics & drawing tools
- 3D technology
- Network support
- Free 24-hour, 7-day help line
- External database access via DataLens
- Relational database manager
- Add-in Toolkit allows design of your own add-ins



Do you wonder what someone in another country thinks about current International events?

Do you want to communicate quickly and economically with a colleague or relative thousands of miles away?

Interested in a demo of the latest video game?

As a **MINK LINK!** member you could communicate with people all over the world, download the latest in public domain software, participate in online games, make use of our fax service and much more. For a business or education group, we can design your own communication service. And now, for the true novice, **MIND LINK!** has a beginner's guide which is a step-by-step tutorial of how to get online and use the system's features.

There's every reason to try it!

Call 576-6172 for your membership today.

Data: 576-1214, 685-1214, 856-3231

Fax: 574-3492

Voice: 576-6172



MIND LINK

MIND LINK! -- The way things should be done.

TianMa

天馬

SOLVING THE CHINESE LANGUAGE PUZZLE

For business with the Far East...
Create a winning situation by communicating with your clients in their own language.

For scholars and professionals...
Write Chinese as naturally as you pronounce the words - and almost as fast.

Dealer Inquiries Welcome.

ALPHA COMPUTER AUTOMATION

555 West Hastings Street, Lower Mall, Harbour Centre
Vancouver, B.C. V6B 4N4 * Phone (604) 684-8146 * Fax (604) 684-8128

We offer translation and Chinese word processing services.

繁簡由之，宋體，黑體，楷體皆可。

SHARP COLOUR



**\$UNBEATABLE
PRICE**

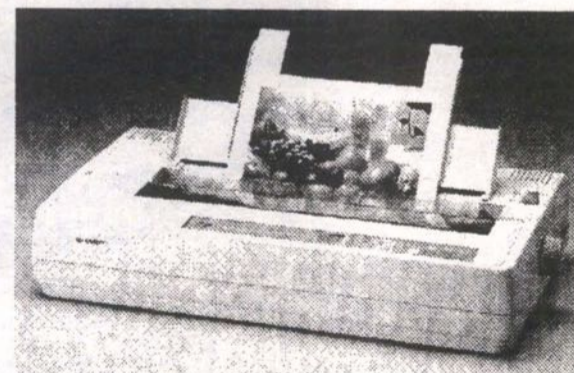

**SHARP TECHNOLOGY BRINGS YOU THE MOST DRAMATIC
BREAKTHRU IN NATURAL COLOUR PRINTING AT LOW COST.**

SHARP JX730 COLOR INK JET

- Fast Printing with 48 ink nozzles
- Printing in seven vivid colours
- 13.6" maximum printing width
- True-to-life colour reproduction at 180 x 180 dpi
- Standard centronics parallel port

See the complete line of
**Sharp laptop computers,
laser printers, colour scan-
ners and projection panels.**

Available only at

872-3225 **MINITRONICS** 872-3226

1986 Kingsway at Victoria Drive, Vancouver

GREAT OFFICE PACKAGES FOR PROFESSIONALS!

COMPLETE OFFICE SERVICES, FIVE MINUTES FROM DOWNTOWN

- Fully-furnished, executive offices
- Personalized telephone answering
- Executive secretarial and word processing
- Photocopy, facsimile, courier and mail services
- Elegant, fully-equipped boardroom
- Underground parking
- Private courtyard
- Overlooking downtown and mountains
- Business identity plan service
- Daily, weekly, monthly and long-term office rental
- Daily boardroom rental

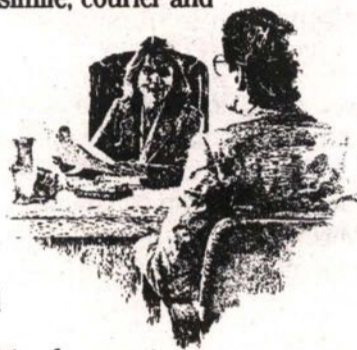

TAKE IT FROM OUR CLIENTS:

Executive 1 is the essential link between my clientele and myself. Christine and her staff provide a vital service to my business and they realize this. Their professional approach has been the key.

Norman Hovan
Macintosh Consultant
Rockland Coast Projects
(Business ID Client)

I have had the pleasure of being in two other packaged offices. Executive 1 is by far the best I have seen. The staff is very professional and extremely competent. The offices are professionally laid out and the boardroom offers all the amenities of a corporate head office boardroom. The location is also ideal.

Nick Marchi
Sales Manager
Decision Data
(Office Tenant)

Professionally Yours

EXECUTIVE 1
BUSINESS CENTRE LTD.

101-1965 West Fourth Avenue, Vancouver, B.C. V6J 1M8
Telephone: (604) 737-2114

We Make Computers Easy.

THIS EASY
286-16 MHz

w/40MB HD

14" Monochrome Monitor

\$1299

Come In And See

Arete 386SX-16MHz **\$1,350**

Arete 386-25 MHz **\$1,699**

Arete 386-33 MHz **\$2,250**

MITSUBISHI On Display

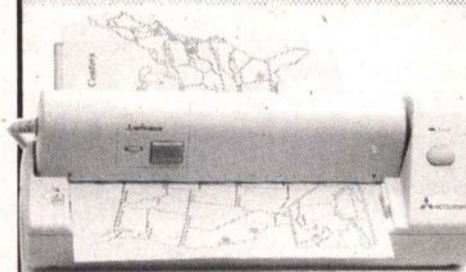

VGA COMPATIBLE
XC1429CH
640 x 480; 0.28mm (dot)

Easy To Connect

PORT Lite

Local Area Network provides flexible disk and printer sharing for DOS computing without the complex management requirements of high priced LANs. Either dedicated file servers or workstation/servers can be configured at any node. All with an icon and menu driven interface.

Puzzled by Point-Of-Sale? So were we.

We took a look at many of the POS systems on the market right down to the code and found there is no single standout.

Some would be effective here, but useless there.

We'll help you determine which system provides the right tools for your retail or distribution business.

We'll help you implement and troubleshoot your change to automation.

We understand POS

HIGH DENSITY 3.5" DISKS

While quantities last. Limit 1 per customer.

\$17⁹⁹ / box

ARETE COMPUTERS
3168 W. BROADWAY
731-0592



much in the way of performance to get a WYSIWYG interface. In fact, what you see is not what you get. What you see is a nice screen and what you get is a slow application.

Support is available 24 hours a day, 7 days a week (except holidays), and it is free. This is definitely noteworthy. Most support lines are open only during normal working hours. If the publisher is in Eastern Canada or the Eastern United States, the support lines will most likely go by Eastern time. This means that support for users out west ends at 2 pm PST.

Documentation

With the Bitstream fonts, your output can be as professional-looking as word processing typeset with a desktop publisher such as Ventura Publisher. Combine Lotus 1-2-3 with a color laser printer and you have superb reports and presentations. Run transparencies through a laser printer and you have excellent overheads for group presentations. In short, Lotus 1-2-3 produces excellent output. Other spreadsheets rely on exporting to other programs to produce higher quality documents. With Lotus 1-2-3, most of this power is included in the package.

In addition, there are many add-ins available for Lotus 1-2-3 as evidenced by the Add-in Toolkit and Add-in Manager. These greatly increase the possible applications of Lotus 1-2-3.

The documentation for Lotus 1-2-3 is excellent. Each function is described with screen shots. An easy-to-use workbook will have new users familiar with the spreadsheet's basic functions in a few short lessons.

While some software publishers are trying to save on packaging costs, it is a delight to see that Lotus packaging is still very professional. The old-style slipcase is still the most convenient way to keep your software documentation organized.

Limitations

Users are limited to 8192 rows and 230 columns.

The sluggish graphical interface is the only limitation that the vast majority of users will encounter with release 3.1. While the WYSIWYG interface is advertised as making the product easier to use, it is only of use to those with quite fast hardware.

I use Lotus 1-2-3 Release 3.1 on a 80386 16 MHz machine, and the time it takes to move around using the graphical interface, even on the speed of this machine, would frustrate most users. You really have to like all the fancy graphics to want to put up with this.

Conclusion

With Release 3.1, Lotus 1-2-3 is still the dominant spreadsheet. There is not a spreadsheet available that is more powerful. Its output is unmatched by any other spreadsheet I have seen. For complex spreadsheet applications and top-notch presentations I would recommend Lotus 1-2-3 Release 3.1.

NEC
UltraLite™

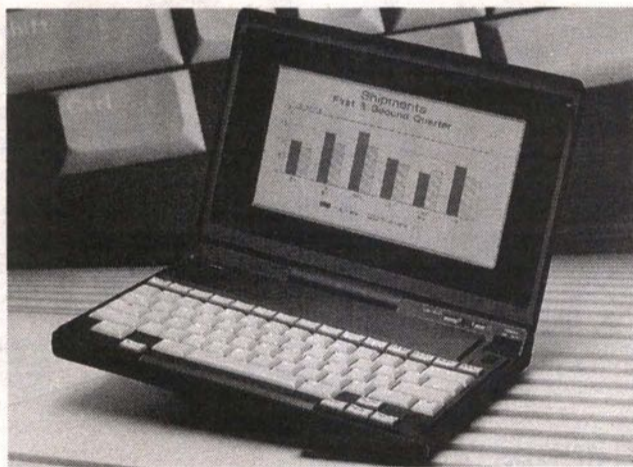

Technical Excellence Award

- 2 MB silicon hard disk
- 4.4 lb incl. battery
- 1.44 MB external drive
- 2400 baud modem

~~\$4495~~

\$1395 GST incl.

Limited Quantities

Phone toll-free 1-800-663-1061

Canada Portable Computer

204 - 20189 56th Avenue, Langley, B.C. V3A 3Y6 · Telephone 604-534-6441 · 1-800-663-1061

SPREADSHEETS

PlanPerfect

by George Slade & Steve McIlwain

Product: PlanPerfect V. 5.1, Spreadsheet software for IBM personal computers and PC networks.

Publisher: WordPerfect Corporation, 1555 N. Technology Way, Orem, Utah 84057 (801) 225-5000

System Requirements: IBM XT/AT or compatible, DOS V. 2.0, 2 floppy drives or a hard drive; 384K RAM required, 512K recommended, may operate on a network.

Price: C\$645.

Key Features

- Automatic timed backup
- Dual worksheet editing
- Relative, absolute, mixed cell addressing
- Integrated graphics
- Import/export
- Lock/unlock cells
- Merge worksheets
- Automatic calculation
- Password security
- Optional Lotus style interface
- Virtual memory
- Most of the familiar WordPerfect features

Overview

PlanPerfect is a full-featured two-dimensional spreadsheet. It has a standard spreadsheet structure, with a capacity of 256 columns and 8192 rows. Graphs

can be produced from data in any section of your worksheet.

Setup and Ease of Use

PlanPerfect installs from a prompt-driven installation program. You have many options on what you wish to install. One option which is particularly beneficial is the ability to install only one printer driver.

With over 600 printer drivers, if you automatically installed all of them, you would waste a lot of hard disk space. This seems only too obvious, but many software packages install a myriad of printer drivers when you will only use one or two. The total time to install PlanPerfect is about 15 minutes.

Plan Perfect, like all WordPerfect software packages, comes with an on-line tutorial. This tutorial will take you approximately 60 minutes to complete. Once you have completed the tutorial, you are able to perform most simple functions in PlanPerfect.

If you already use WordPerfect, you will find PlanPerfect particularly easy to use as the interface is very much the same. If you are not already using WordPerfect, you may find yourself getting lost with the function keys but you can always use the Lotus interface or the drop-down menus.

PlanPerfect combines three simultaneous user interfaces. You can use the "slash commands" as in Lotus 1-2-3. You also have the familiar WordPerfect function keys, as well as the version 5.1 pull-down menus, and a mouse. All these interfaces are available at the touch of a key or mouse button, providing the user quite a powerful interface.

Reports and Output

PlanPerfect has basically the same printing power as WordPerfect. You have the same 600 printer drivers available, and the capacity of up to 32 different base fonts per spreadsheet. PlanPerfect has the potential for professional-looking printing, but this depends on your printer's capabilities and the fonts you have.

Documentation

The manual is written much like the WordPerfect manual. It is strictly a reference manual, listing features and functions alphabetically. There is also a companion workbook that offers an alternative to the tutorial.

Unlike the tough three-ring binder and slipcover WordPerfect packaging, PlanPerfect is a soft perfect-bound manual that comes in a box with a pull-off top. Accessing the slipcover-type manual on a tight shelf with the normal office clutter is much nicer than pulling out the PlanPerfect box and opening it up (and then picking up all the papers you just knocked on the floor that were on top of the box). This probably sounds a little picky, but when you pay \$645 for a product, you expect more thoughtful packaging.

Limitations

PlanPerfect is not limited to 286- or 386-based machines with extended or expanded memory as other spreadsheets. You can run PlanPerfect quite effectively on an aging 8088-based machine.



Conclusion

Most frequently, one tends to find spreadsheets the most difficult of application software to tackle, and people who do not use spreadsheets frequently are intimidated by them. PlanPerfect is user friendly, and even more so if you are already using WordPerfect. The marriage of three user-interface types simultaneously available on one system is impressive.

WordPerfect Corp. has made PlanPerfect so identical to its word processing package that it should definitely be considered by WordPerfect users.

PlanPerfect may not be the most popular or most powerful spreadsheet available. However, for the user who does not require the exhaustive functions of Lotus 1-2-3 and simply requires a powerful two-dimension spreadsheet, PlanPerfect is perfect. PlanPerfect gives you everything you want in state-of-the-art spreadsheet management without making your current equipment obsolete.

George Slade & Steve McIlwain are senior partners in ISR Software Review Corporation, a company specializing in independent testing, evaluation and review of DOS-based products. For further information, phone (604) 538-0517.

POLYTECH
COMMUNICATIONS

1082 Kingsway
Vancouver, B.C. V5V 3C6
Tel: 879-8823 FAX: 879-1485

SPRING SALE! (G.S.T. SPECIALS)

SUPPORT
SERVICE
SALES80386 - 25MHz
AT SYSTEM

- Intel 80386-25 CPU, zero wait state
- 1MB RAM expandable to 16MB on board
- 1.2MB 5.25" floppy drive
- 45MB hard disk (IDE 25 ms) voice coil
- Monographics card w/Printer port
- 12" Amber Monochrome TTL Monitor
- Parallel, serial and game port
- 101-key enhanced keyboard
- Full height AT case

\$1575

* Above system with 64K cache on board
\$1725

* Above system with 33 MHz CPU, 64K cache **\$1925**

ENTRY LEVEL 286 AT

- 80286-12 CPU, 12MHz, O.W.S.
- 1MB RAM on board
- 1.2MB 5.25" floppy drive
- 45MB hard disk (IDE 25ms) voice coil
- Monographics card & 12" amber monitor
- Compact AT case
- Parallel, serial and game port
- 101 Keys Enhanced Keyboard

\$875

386SX-16
SYSTEM

- 80386SX-16 CPU, O.W.S.
- 1MB RAM expandable to 8MB
- 1.2MB 5.25" floppy drive
- 45MB hard disk (IDE 25ms) voice coil
- Monographics card & 12" amber monitor
- Parallel, serial and game port
- Compact case
- 101-key enhanced keyboard

\$1295

OPTIONAL UPGRADES

(ADD TO SYSTEM PRICE)

- Additional 3.5" 1.44MB or 5.25" 1.2MB floppy drive **\$80**
- Mitsubishi 62MB voice coil (28ms) w/RLL controller **\$115**
- Maxtor 80MB IDE (19ms) w/64K cache ... **\$235**
- Rodime 110MB IDE (18ms) w/64K cache. **\$325**
- Rodime 210MB IDE (18ms) w/64K cache **\$775**
- Fujitsu 135MB IDE (20ms) w/64K cache .. **\$365**
- Fujitsu 180MB IDE (20ms) w/64K cache .. **\$575**
- Maxtor 200MB IDE (15ms) w/64K cache **\$695**
- Samtron (by Samsung) 14" color VGA monitor (640x480) w/16 bit VGA card (256K) **\$270**
- Samtron (by Samsung) (800x600 .31dp) 14" VGA color monitor w/16 bit VGA Card (256K) **\$350**
- AOC 14" Super VGA monitor (1024x768 0.28 dp) w/Trident VGA card (OEM) (512K exp. to 1MB) **\$395**
- Seiko Super VGA monitor (1024x768 0.26 dp) w/Trident VGA card (512K exp. to 1MB) **\$695**
- NEC 3D Multisync w/Trident VGA Card (512K exp. to 1MB) (1024 x 768) **\$850**

PRINTERS (WITH CABLES)

- Panasonic KXP-1180 (9-pin) **\$220**
- Panasonic KXP 1124 (24-pin) **\$395**
- Fujitsu DL1100 fast printer (24-pin, 80 col.) **\$400**
- Fujitsu DL3450 fast printer (24-pin, 132 col.) **\$525**
- Hewlett-Packard HP LaserJet IIP ... **\$1375**
- Hewlett-Packard HP LaserJet III ... **\$2225**

ACCESSORIES

- Logitech Hi-rez serial mouse **\$79**
- Logitech serial mouse w/Windows 3.0 **\$150**
- 2400B internal modem (Cardinal) .. **\$105**
- 2400B external modem (Cardinal) .. **\$130**
- 2400B internal modem (CPI) **\$95**
- 2400B Pocket Modem (PPI) **\$129**
- Zoltrix Send/Receive Fax Modem Card **\$190**
- MS-DOS V4.01 w/GW-BASIC **\$75**

MATH COPROCESSOR

- 80287-10 **\$285**
- 80387SX-16 **\$415**
- 80387DX-20 **\$495**
- 80387DX-25 **\$575**
- 80387DX-33 **\$715**
- Cyrix 33MHz math chip **\$665**

ALL SYSTEMS WITH STANDARD 2 YEARS LABOUR AND ONE YEAR PARTS WARRANTY

SPREADSHEETS

Quattro Pro

V. 2.0

by Kirtan Singh Khalsa

Overview

This upgrade, while leaving much of the underlying spreadsheet features intact from previous versions, adds useful presentation features, improved export/import to Lotus 1-2-3 Release 2.2 and pseudo 3-D graph types.

Setup and Ease of Use

Setup was straightforward with this new release. Six disks and a few minutes allowed us to jump right into the program. It took a bit of effort to get the mouse working.

The first impression of the interface is that it looks very similar to a Windows-style menu-based screen. The difference is that the menus are addressed, not by "Alt-F" for the File menu, but instead with the older "/" used in Lotus-style programs. Once you get past that obstacle, Quattro Pro has a very easy to use interface.

Users accustomed to the older Quattro Pro interface have the option of switch-

ing back to the older approach. The new view, with the menus at the top of the screen, I found sufficiently appealing and useful to want to endure the relatively short learning curve to continue using it.

The new interface is not entirely WYSIWYG. There is no dynamic page-break preview and you have to jump into page preview to see what is actually going to print.

Database Connections

According to the material provided with the package, if you use Borland's other best-selling product, Paradox, which is a relational database, the two



Product: Quattro Pro 2.0

Publisher: Borland International Inc., 1800 Green Hills Rd., Scotts Valley, CA 95066; (408) 438-8400.

System Requirements: IBM PC or compatible, 512K, standalone; 640K on network (This spreadsheet features access to Borland's Paradox database product. This access requires an additional 2MB of extended memory).

Price: US\$495 (upgrade from 1.0: \$79). LAN Pack costs US\$295. Borland also was offering upgrades to Quattro Pro for \$99 from other high-end spreadsheets.

Key Features

- New "hypershow" presentation capabilities
- 3-D graph types
- Integration with Paradox database
- Optional SQL Link package to other databases
- Underlying engine largely unchanged from previous version
- Goal-seeking utility
- ProShow slide show add-in product
- Imports CGM clip-art to graphs

Scalable *on-the-fly* Fonts for Windows 3.0 & WordPerfect

ShowTime **Burlesque** *Opera* **Geneva** **Tiempo**
Chancellor *Artisan* *Celebrity* **Gypsy** **Hippo** **Prodigal** *Victorian*
 Geneva Condensed Symbols ☺☻☼☽☾☿☽☾☿✓✓θμδφλζσγ
 Enchanted Textbook Advantage NoteBook
 Geneva Narrow Geneva Light **Geneva Black** Journal Novelty
Civilian Cordial Marque Gourmand Imperial

Each new Super Starter Kit installs automatically in minutes and activates all of the font options in your application's font menu. Just select a font, a style and a point size from 3 to 999 point — you can even select effects like reverse, shadow, and outline right from the font menu. When you print, the fonts and effects you selected are generated on-the-fly in seconds.

Join thousands of users already using MoreFonts, order your Super Starter Kit today and start using fonts the easy way.

- 100% Windows 3.0 & WordPerfect 5.0/5.1 Compatible
- Works with LaserJet, LaserJet Plus Series II, IID, IIP, III, and compatibles and dot matrix printers (9 & 24 pin) and DeskJet, Plus & 500 printers
- Fonts scaled from 3 to 999 points
- Created on-the-fly in seconds
- Windows on-the-fly Screen Fonts
- Regular, **Bold**, *italic* and **bold italic**
- Portrait & landscape
- Easy to install software
- Over 2000 Special Effects

■ Each Super Starter Kit supports WordPerfect 5.0/5.1, MS Word 5.0, PageMaker, Word for Windows, Ami, Ami pro, PerForm Pro, Powerpoint, MS Excel, Formbase, Gem Ventura Publisher, First Publisher, XyWrite III Plus, MultiMate 4.0, ■

System Requirements: You can use the Super Starter Kit with your standard PC and printer. You can use a dot-matrix printer, DeskJet, LaserJet or compatible, and Postscript. Your Super Starter Kit is easy to install software.

• It's like getting a 500,000 in 1 font cartridge for only \$189.95. •

Special
Introductory
Offer
\$189⁹⁵

YOUR SUPER STARTER KIT INCLUDES:

- Automatic font installation software for MS Windows 3.0, WP 5.0, 5.1, MS Word 5.0
- Scalable fonts shown
- Learn how you can buy additional fonts from \$22.50 each.

ORDER TOLL FREE

Dealer inquires welcome

(800)465-9251

Pub
Tech
Inc.

Publishing Technologies

824 Clearview Avenue
London, Ontario, Canada N6H 2N2
(519) 657-0406 • FAX: (519) 472-2951

All products mentioned are trademarks or registered trademarks of their respective companies.

programs can run interactively. This requires at least an AT-class or better computer and 2 MB of extended memory above and beyond what you need to run Quattro Pro itself.

We did not try this feature, but it seems to make sense that the sum would be greater than the parts if you could achieve dynamic integration. Spreadsheet databases tend to require a lot of keyboard strokes to achieve what a database can do with one command.

Spreadsheets, however, offer more flexibility in experimenting with numbers once you have extracted them. A dynamic link would allow a logical division of labor.

This feature is not exclusive to the Quattro-Paradox duo. Lotus 1-2-3/G offers DataLens, which allows users to interface with a number of high-end databases. Windows users, although currently limited to a small number of Windows databases, have the power of DDE, or Dynamic Data Exchange to do much the same thing.

Quattro Pro fortunately does not stop with the link to Paradox, but also offers an optional SQL Link, which allows it to front-end for networked SQL database servers. In addition, Quattro Pro has always been able to extract data from dBASE files.

Performance

If you don't have a computer powerful enough to run Windows Excel, or you just plain don't like Windows, Quattro Pro offers a very strong alternative, without sacrificing presentation-quality

SPREADSHEETS

SuperCalc 5

by George Slade & Steve McIlwain

Overview

SuperCalc 5 is a full featured 3-dimensional spreadsheet package that offers spreadsheet management, data analysis and visual presentation. It offers the standard worksheet structure of columns, rows and cells, with an optional Lotus-style interface.

Setup and Ease of Use

SuperCalc 5 has as poor an installation procedure as I have seen in many years. The instructions say to create a directory and copy all the distribution disks to that directory.

If you follow these instructions literally you will end up with many files you don't want or need. If you are installing SuperCalc 5 onto a network, the procedure is very long and complicated with numerous manual changes to your DOS environment. It seems to me that "the world's leading independent producer of software" would employ someone who could write a user-friendly installation program, like everyone else in the software industry.

Once you have gone through the ancient installation procedure and loaded SuperCalc, you find a spreadsheet program rich with functions (it takes 20 pages of the Quick Reference manual to simply display all the menu options on a menu tree).

SuperCalc 5 uses the aging "slash" command Lotus-style interface. The menu has many more features than Lotus, but one has to ask oneself, why would anyone want to copy the Lotus user interface?

Sure, Lotus is the top spreadsheet program and has a lot of features, but this interface is five years old and needs to be re-worked. SuperCalc 5 would be better off with a more creative and better-designed user interface. (It can be done. Just look at PlanPerfect.)

You can choose to use a Lotus-style SuperCalc 5 menu system or an exact duplicate of the Lotus 1-2-3 interface. For some reason, the status bar help for each command is missing on the Lotus 1-2-3 interface but is present on the SuperCalc 5 menus.

The on-line tutorial is very effective and we recommend it highly for first-time users. After using the tutorial, you can perform the basic spreadsheet functions.

Reports and Output

SuperCalc 5 has basically the same printing power as all Computer Associates products. In addition to the standard Computer Associates printer drivers, SuperCalc 5 includes a copy of Sideways, a utility that allows one to print spreadsheets sideways, and about a dozen device drivers to extend the output.

One of the device drivers will allow output to be transferred to Ventura Publisher, for typeset-quality reports.

Documentation

The documentation is complete and concise, and includes a reference guide and a user guide that can help users

graphics or decent speed. Quattro Pro has a smaller RAM requirement than the new Lotus 1-2-3 V. 3.1.

Virtual memory management allows the program to swap segments of code in and out of memory. The result is that you can live below 640K. The new version of Lotus, in contrast, needs a minimum of 384K of extended memory.

Quattro Pro offers three types of calculation modes. In automatic mode, every time you enter a change in a spreadsheet, the spreadsheet recalculates. In manual mode, the spreadsheet puts off recalculating until you issue the F9 command to do so.

Finally, the program has a background mode. With this setting, the spreadsheet will update between keystrokes. In this background mode, it is quite slow to update, but in either of the foreground modes, updates are very fast, exceeding those of the new Lotus.

Macros are another strong point of the package, especially with the excellent macro debugger.

Graphics Capabilities

People doing presentation graphics will appreciate the ability to import logos and other clip art stored in CGM, EPS or PCX files. The CGM format means that users can import Lotus Freelance Plus and Harvard Graphics images.

Included on disk is a modest clip-art library. Graphs can be copied from one worksheet to another. This copying capability makes the reuse of standard charts simple and fast.

Another aid to those doing presentations is Quattro Pro's ability to install point-and-click graph buttons that allow links to other graphs or to macros. With these interactive text boxes, one can visualize an easy-to-use and easy-to-set-up Executive Information System.

These same techniques could be used to set up a slide sequence to make formal presentations more lively, because the real numbers are accessible, not hidden behind another level of software.

On VGA systems, Quattro Pro supports up to 132-column displays.

This new version also includes an increased number of graph styles including 3-D bar, line, and area graphs. They are kind of pseudo 3-D graphs—they are really just 2-D graphs in which the data series are plotted behind one another and displayed in 3-D perspective.

Import/Export

Lotus users will find themselves right at home with Quattro Pro. There are three options for interface, the best I think is the new Quattro Pro, but users can also choose a Lotus-clone approach or the old Quattro Pro Version 1.0 interface.

Files can be imported and exported to Lotus 1-2-3 Version 2.2 easily. Most file-linking commands are automatically converted on import, which saves manually converting the links across spreadsheets.

Goal Seeking

Linear optimization has never been easy to set up in spreadsheets. The first spreadsheet to make this function relatively easy was Lotus 1-2-3/G with its Back Solver. Quattro Pro includes a simple goal-seeking utility that when set up, will automatically find the values

better understand the concepts of the package. Error messages are documented and explained in an appendix.

Limitations

SuperCalc 5 is not limited to 286- or 386-based machines with extended or expanded memory as other spreadsheets are. SuperCalc 5 is limited to 229 columns by 9999 rows. You can display up to three worksheets on your screen simultaneously.

SuperCalc 5 includes an Audit mode that can go through your spreadsheets and debug them for incorrect formulas, etc. This is of particular interest to people creating huge spreadsheet programs with complex formulas.

Conclusion

For highly complex spreadsheet applications, SuperCalc 5 is very effective. The worksheet audit feature is much like a program debugger. For a first-time user the user interface may be a little cumbersome, but in time one gets used to it.

In choosing a spreadsheet you must estimate how many features you wish to use, then purchase the one package that gives you all the functions you need. It is no use purchasing a simple, easy-to-use spreadsheet when you need 3-D spreadsheets. If you need complex spreadsheets, SuperCalc 5 is a worthwhile investment.

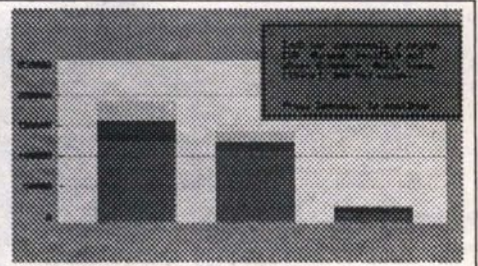

Product: SuperCalc 5, spreadsheet software for IBM personal computers and PC networks.

Publisher: Computer Associates International Inc., 3rd Floor, 1770 Burrard St., Vancouver, B.C. (604) 733-2343

System Requirements: IBM XT/AT or Compatible, DOS 3.0, hard drive, 640K RAM required, mono, CGA, EGA, VGA monitor, can operate on a network

Price: C\$599.

Key Features

- LIM V. 4.0 support
- Integrated graphics
- Import/export
- Search and Replace
- Macro Libraries
- Loads and saves Lotus 1-2-3 files
- 3-D linking up to 255 spreadsheets
- Data encryption
- Computer Associates Graphics Service available.
- Audit mode

MUSIC and COMPUTERS

We sell and service the best music software & music hardware!

Specializing in MS-DOS and Compatibles

- Cakewalk
- MusicPrinter Plus
- Band In A Box
- Personal Composer
- Final Cut
- Roland M.I.D.I. Interfaces & Sound Cards

Receive 10% off
your new software with this ad
offer expires February 28, 1991

Carillon Music Ltd.

160 - 8171 Ackroyd Road, Richmond
276-2383

Full Compatibility Incredible Performance

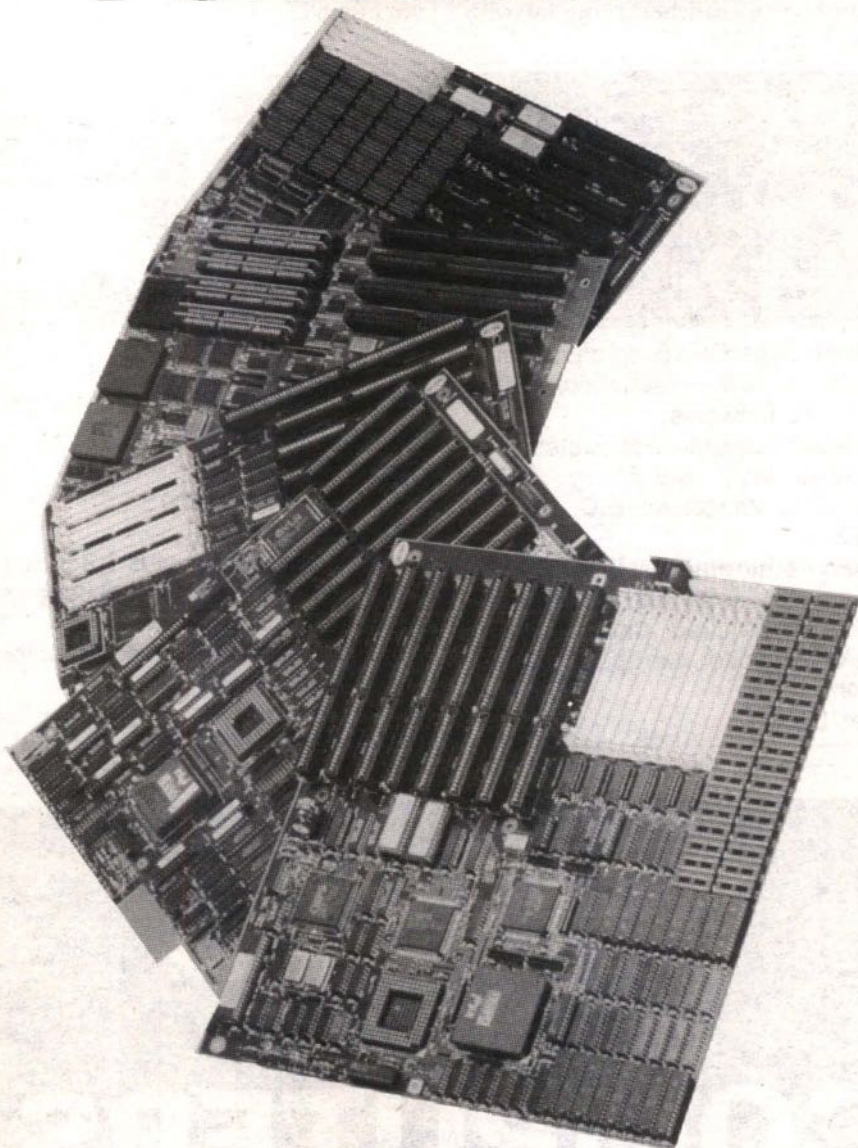

SYSTEM BOARDS:

Fujikama 486 and 386 System Boards feature:

- 100% IBM, Novell compatibility
- Zero-Wait States
- LIM EMS 4.0 Support
- UNIX/Xenix, OS/2 compatibility
- Real-time clock/calendar
- 13-Month Warranty

FUJIKAMA
O.A. DISTRIBUTION (WESTERN) INC.

#130, 6751 Graybar Rd., (near No. 9)
Richmond, B.C. Canada V6W 1H3

Tel: 604-273-3838

Fax: 604-278-6368

B.C. & Alta Toll Free: 1-800-663-KAMA (5262)

DEALERS ONLY PLEASE

• VANCOUVER • TORONTO • MARKHAM
• MONTREAL • CHICAGO

SPREADSHEET ADD-ON PRODUCT

F9

Version 1.11

by George Slade

Overview

F9 provides instant retrieval and analysis of ACCPAC Plus G/L information from within a Lotus 1-2-3 worksheet. F9 allows you to access information in your ACCPAC Plus General Ledger account file as if it is a cell in your Lotus 1-2-3 worksheet. It uses the reporting power of Lotus 1-2-3 to produce financial reports that are not available in the ACCPAC Plus Financial Reporter.

Report writers are exciting products. There are currently two report writers for ACCPAC Plus: F9 and Quick Reports. Each of these solve a different problem. F9 gives you the ability to use Lotus 1-2-3 power to manipulate your ACCPAC G/L data, whereas Quick Reports is not as powerful in data manipulation, but you can access data from all your ACCPAC applications. I have worked with both these products and find them very useful in different areas.

Setup and Ease of Use

F9 installs with a menu-driven installation program. This program also attaches F9 to Lotus 1-2-3 as a Lotus 1-2-3 add-in.

When you load Lotus 1-2-3, F9 is available to you as an add-in process. All the Lotus 1-2-3 commands are available, as well as some special F9 commands, such as @DESC() which prints the description of the account used from the ACCPAC database. The function names for reporting are similar to those used in the ACCPAC Plus Financial Reporter, thus there is little confusion.

The F9 user interface is identical to the Lotus user interface so when you are using specific F9 functions you do not notice you are not running Lotus 1-2-3.

One warning to potential users of F9. In order to gain full access to all the power of F9, you have to register your copy with Synex Systems. This may seem a picky criticism, but after you spend your money for a software package, you expect to have the full working copy available in the box. With this in mind, do not start working late Friday night hoping to spend the weekend on a project that is due on Monday. Until you register the product you are limited in what you can do.

Another fact you will have to deal with in implementing F9 (and all report writers in general) is that you have to know the structure of the files you are accessing data from. If you do not know where the data is, you cannot create a report on it.

For example, if you want the balance of account, do you want the current balance or the current period balance, or do you want the last period balance? All this information is stored in different fields of the database.

Reports & Documentation

The range of reports you can produce from a financial reporter such as F9 is virtually unlimited, or in this case limited to the power of Lotus 1-2-3. Financial report writers in general are a very useful tool, and it is easy to get excited about

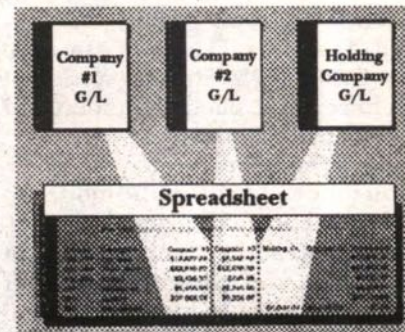

Product: F9 Version 1.11, general ledger financial reporter for ACCPAC PLUS General Ledger with Lotus 1-2-3. For companies whose reporting requirements are too complex for the reporting function of ACCPAC PLUS General Ledger.

Publisher: Synex Systems Corporation, 800—1176 West Georgia St., Vancouver, B.C. Canada V6E 4A2. Phone (604) 688-8271, Fax (604) 688-1286.

System Requirements: IBM PC, XT, AT, PS/2 or compatible, DOS 2.1 or higher, ACCPAC PLUS General Ledger V. 5.0 or higher, Lotus 1-2-3 V. 2, 2.01, 2.2, hard disk (or network drive), 512K RAM, 640K recommended. Versions also available for Macola, Great Plains, Solomon, Platinum and SBT.

Price: C\$699.

Key Features

- Automatic ACCPAC G/L interface
- Additional @functions
- Create Turn Key reporting systems

the various types of information you can produce.

Let your imagination go wild to dream up the information you want, then use F9 with Lotus 1-2-3 to get that information produced in a format that effectively communicates the data. Graphs, charts, pie charts and text tables can all be produced.

The documentation is not flashy but is complete, concise and easy to read.

Limitations

F9 will only work with Lotus 1-2-3 Release 2 up to release 2.2. As Lotus is now shipping release 3.1, you must be careful to purchase release 2.2 if you are planning to use F9. Retailers still can order release 2.2 of Lotus 1-2-3 and some may even have it on the shelf. F9 does work with ACCPAC Plus versions 5.0 and higher.

Until you have registered your copy of F9 you are limited to 40 cells of general ledger data per spreadsheet and you are limited to the number of @functions you can execute per spreadsheet.

Conclusion

F9 provides a very useful function to those who need more from their ACCPAC G/L data. When you know the information is there in the database but you cannot get it out it is very frustrating.

With F9 you can access the data and present it any way you wish. I recommend F9 to anyone who is not satisfied with the ACCPAC Financial Reporter in the G/L.

PERSONAL TAX SOFTWARE

Cantax and Hometax Plus

by Steve McIlwain

In the world of personal tax preparation software, for the last few years one product has dominated the marketplace—Cantax.

Now there is a new player, Hometax Plus. Hometax Plus is produced by the same company that produces TaxPREP, one of the major commercial tax preparation packages. Now that there are choices in which package you should use for preparing your own tax return at home, we feel we should compare them head to head.

Product: Hometax Plus Personal tax preparation software.

Publisher: Hometax Information Systems, 402—55 Adelaide St. East, Toronto, Ont. M5C 1K6

System Requirements: IBM XT/AT or compatible; 512KB RAM; DOS 3.1; 2.5MB of free disk space.

Price: C\$49.95 plus GST.

Of Interest To: A person who wishes to prepare his or her own simple personal tax return, and keep an electronic record of their personal financial position.

Key Features: T1 tax preparation and printing; Tax planning; Financial recordkeeping; Personal directory; Expert tax advice; Financial calculations.

Overview

Hometax Plus will prepare a simple T1 tax return for one or more individuals. Hometax Plus also has a number of additional features: tax planning, expert tax advice, financial information portfolio, personal directory, and financial calculation utilities.

Setup and Ease of Use

The program installs itself with a simple and complete installation utility.

Once installed, I was able to prepare a simple tax in 20 minutes. In preparing the tax return form with Hometax Plus, the user moves down through the whole form in much the same way as filling the form out by hand, and the entry screens also look similar to the actual tax-return form. This makes a more difficult user interface.

For the other features of Hometax Plus such as the tax planner and the financial recordkeeping program, the user interface is certainly very acceptable, but the layout of the tax return preparation area seems counter-productive to the preparation of a tax form. One hopes that tax preparation software is designed to make it easier to prepare a tax return. This does not appear to be the case with Hometax Plus.

Reports & Documentation

Hometax Plus allows the user to produce a proper tax return. We did find that if the return was printed on a HP Laserjet series II the return did not print out correctly on the page. I did question Hometax on this issue and they promised me a new disk which they said would fix the problem.

Hometax Plus's documentation is complete and also includes a book on expert tax advice. I read this book, and what struck me was, if I used the advice in the book Hometax Plus would then be useless to me because my tax return would be too complex for Hometax to handle.

Limitations

No errors were encountered while using the package.

This tax preparation package is very limiting. In fact, on page 9 of the manual there is a list of 36 different schedules which the program does not produce. For my personal tax return, there are five schedules which cannot be produced by Hometax Plus. For my partner's tax return there are eight schedules which cannot be produced by Hometax Plus.

As a matter of fact, I quickly looked at the tax situation of ten of my friends and only one can have their complete tax return prepared by Hometax Plus. Hometax Plus claims that their limitations only exclude 15% of the taxpaying public as the other 85% have such a simple tax situation.

However, it is just those who have a little more complicated tax situation that are looking for a software package to simplify it for them. If my tax return is so simple that Hometax Plus could prepare it, I would probably go to H&R Block or Bentax because they would charge me much less than what Hometax Plus costs.

One function that Hometax Plus boasts is compatibility with Quicken Accounting. The theory is that you keep your bookkeeping in Quicken, then when it comes to tax time, Hometax Plus takes the information from Quicken and your tax return is prepared from that.

This is a great idea and would be excellent for most professionals. The problem is that anyone who would use Quicken could not use Hometax Plus because of its significant number of limitations.

Conclusion

Hometax Plus prepares only very simple tax returns. It is quite limited as to the schedules it can produce. Complex returns have to be handled by direct entry of information from other forms not included. This severely limits the functionality of Hometax Plus as a tax return preparing package. However, it does have some features that Cantax does not that you may or may not find useful.

Product: Cantax Personal tax preparation and financial recordkeeping software.

Publisher: Cantax Corporation Ltd., 68 Pumpmeadow Crescent, Calgary, AB, T2V 5C6 Phone (403) 253-8665; Fax (403) 253-8689

Price: C\$59.95 including GST.

System Requirements: IBM XT/AT or compatible; 512K RAM; DOS 3.1; 1 MB of free disk space

Of Interest To: A person who wishes to prepare his or her personal tax return, and make plans for next year's taxes.

Key Features: T1 tax preparation and printing; tax planning.

CONTINUES NEXT PAGE

LEVEL®

POWER SUPPLY

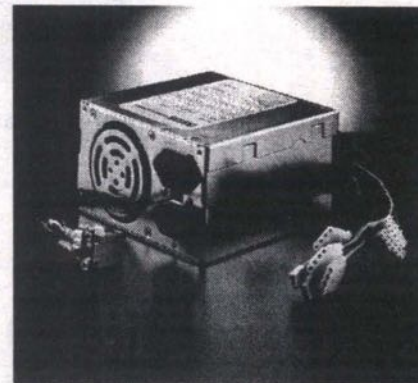
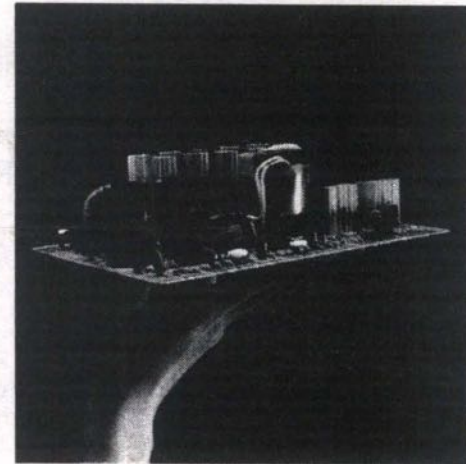

Models LPS-02-200T/220T/250T

- Power good signal
- Operation temp.: 0°C + 50°C
- Dimension:
L x W x H: 210 x 150 x 150 (mm)
- Weight: 2.5 kg (G.)



Models LPS-02-150S/200S/220S

- Power good signal
- Operation temp.: 0°C + 50°C
- Dimension:
L x W x H: 165 x 150 x 150 (mm)
- Weight: 2 kg (G.)



Models LPS-02-150M/200M/220M

- Power good signal
- Operation temp.: 0°C + 50°C
- Dimension:
L x W x H: 150 x 140 x 86 (mm)
- Weight: 1.67 kg (G.)

FOCUSTRONICS & CO.

A DIVISION OF FOCUS ELECTRONIC (CANADA) INC.

#103 - 11511 Bridgeport Road,
Richmond (Vancouver), B.C., Canada V6X 1T4
Fax: (604) 271-8435 Phone: (604) 273-8086

Hours: Mon - Fri 10 AM - 6 PM

3737 W. 10th Ave.
(10th and Alma)
Vancouver, B.C.

VARSITY COMPUTERS
SERVING VANCOUVER SINCE '87

(604) 222-2326
fax: (604) 222-2372

TRISON TURBO AT:

- 12 Mhz 286 processor, switchable to 8 Mhz
- 1 Meg RAM
- 1.2 meg or 1.44 meg floppy drive
- 1 serial, 1 parallel, 1 game port
- 101 keys enhanced AT keyboard
- 40 meg 28 ms hard drive
- Mono monitor and Hercules compatible graphics card

\$799.00

TRISON 386SX AT:

- 16 Mhz 386 SX processor, 1Meg RAM
- 1.2 or 1.44 meg floppy drive
- 1 serial, 1 parallel, 1 game port
- 101 keys enhanced keyboard
- 40 meg 28 ms hard drive
- Mono monitor and Hercules compatible card

\$1200.00

TRISON 25 Mhz 386 AT:

- 25 Mhz 386DX-25 processor
- 1 meg RAM, upgradable to 8 megs on board
- 1.2 or 1.44 meg floppy drive
- 1 serial, 1 parallel, 1 game port
- 101 keys enhanced keyboard
- 40 meg 28ms hard drive
- Mono monitor and Hercules compatible graphics card

\$1600.00



Come see us for the fastest 286-20MHz & 286-25MHz systems on the market as well as 386 and 486 machines

Unit 110-11180 Voyageur Way
Richmond, B.C. V6X 3N8
ELECTRONIC INC. Tel: (604) 278-5151 Fax: (604) 278-5122



DEALER ENQUIRIES WELCOME



Avariety of components and peripherals for DOS, Novell, and UNIX applications, including cases, power supplies, video cards, keyboards, motherboards, etc.

ATIC. Computers

SYSTEM PACKAGES

- AMI BIOS • 1MB RAM
- C&T/Intel Chipset(s)
- 1.2MB 5.25" Floppy Drive
- 40MB/45MB (32K/64K) HD
- 1:1 Interleave Controller
- Mono Card w/Printer Port
- Parallel, Serial & Games Port
- 12" TTL Monitor
- 200W CSA Power Supply
- Enhanced Keyboard
- 1 Year Parts and 2 Years Labour Warranty

AT 286 - 16 MHz

\$838

386 SX16

\$1198

386 SX20

\$1298

386 DX25, 0K

\$1498

386 DX25, 32K

\$1598

386 DX25, 64K

\$1658

386 DX33, 32K

\$1858

386 DX33, 64K

\$1898

486 - 25MHz

\$2688

POS

(Point Of Sale)

Complete System Including:

- Hardware • Software
- Installation

SPECIAL \$1949

Phone Pager 641-5570 for details, appointment or demo!

UPGRADE OPTIONS

- RAM (Per Mega Byte) \$85
- Floppy Drive (HD) \$80
- 60MB Hard Drive (RLL) \$110
- 80MB Hard Drive (19MS) \$238
- 90MB (20MS, 64K) \$288
- Mono VGA (12") 16 bit Card \$98
- 640 x 480 16-bit 256K, .28 DP \$298
- 1024 x 768 16-bit 256K, .28 DP \$358
- 9 Pin Printer w/cable \$188
- 24 Pin Printer w/cable \$378

TRAINING

- DOS
- WordPerfect 5.1
- Windows
- Excel
- MicroSoft Word for Windows
- AutoCad
- Bedford
- Corel Draw
- dBase IV
- Paradox

286-12 Motherboard	\$119	40MB 32K 28ms HD	\$279	ATI Wonder	\$209
386 SX-16 M-Board	\$469	80MB 32K/64K 19ms HD	\$589	OKI 400 Laser	\$969
386-25 M-Board	\$669	1.2/1.44 MG TEAC/Pana.	\$80	Panasonic 1180	\$199
386-33, 64K Cache	\$1059	14" Color 640 x 480 .28	\$359	Pana. 1124/Reven 2417	\$388
80287-10	\$199	14" Color 1024 x 768/.28	\$389	16 bit VGA Card	\$89
80387 SX16	\$399	NEC 3D Monitor	\$886	1MB VGA Card	\$169
80387 DX20	\$499	NEC 4D 16"	\$1839	Hp Laser	\$ call
80387 DX25	\$569	Mitsubishi 16"	\$1739		
80387 DX33	\$669	Sony 1304 14"	\$1139		
Cyrix 386DX25	\$509	VGA 16-bit 256K	\$89		

All Books 20% Off SOFTWARE... CALL!

We SERVICE what we sell!

ATIC. Advance Technology International (Canada), Inc.

45 East Broadway (at Quebec St.) Vancouver, B.C. V5T 1V4
Tel: (604) 875-8859 Software Service: 641-5570 (Pager) Fax: (604) 875-8611

**TAX PREPARATION
CONTINUED FROM P.41**

Overview

Cantax will prepare a T1 tax return for one or more individuals. Cantax also has a tax-planning module which allows you to plan for the next year's tax season.

Setup and Ease of Use:

The program installs itself with a simple and complete installation utility.

Once installed, I was able to prepare a simple tax return within 20 minutes. The entry screens are simple and easy to use, and though I had few problems using the software, I would not rate it as user-friendly as other commercial software. The user interface is useable but certainly not state-of-the-art.

To prepare the tax return form, Cantax uses an index of schedules. The user simply selects which section is applicable to his or her tax situation and edits each section. Thus in preparing the return, the user does not have to sort through information that is not applicable.

Documentation

The main report to consider when it comes to a tax preparation software package is the actual tax return. Cantax produces a proper tax return. There are a few other helpful reports such as a tax summary report and the tax planning report. The tax return I produced completely with Cantax was ready to go with no errors or additional work required.

Limitations

I encountered no errors while using Cantax.

This tax preparation package is only limited from preparing very complex tax returns such as farm income or fishing income (Cantax Plus, a more expensive version from the same company, can handle the more complex returns).

Cantax does not have the financial recordkeeping features of Hometax Plus, although this may not be as much of a liability as it first appears. Many would consider the financial recordkeeping features of Hometax Plus as "fluff". Many of these same functions, with the exception of expert tax advice, could easily be done in other more appropriate programs such as a spreadsheet or personal info manager. Cantax does come with a tax planner to help you estimate your next year's tax situation.

Conclusion

Cantax will prepare most tax returns.

In preparing a tax return form, Cantax is easier to use than Hometax, and Cantax will prepare much more complex returns than Hometax.

Final Conclusion

Customer support could be a big issue for a product such as this. Once you receive your working copy of the tax software, it is close to the beginning of February because Revenue Canada does not approve the software until early January.

This being the case, you only have two months to become familiar with the package and get your return off to Revenue Canada. If you have a problem you need it solved *now*. Cantax has its customer support line right on the software start-up screen, so even if you lose the manual, you know where to call.

In addition, I received an immediate answer to any questions and was not left on hold for more than a few seconds any time I called. The support line for Hometax Plus is not in the documentation or the software.

While Hometax Plus is packaged much better than Cantax, Cantax is the superior software package for preparing tax returns. This is one case where you cannot judge a book by its cover. If you want extra features, such as expert tax advice, financial recordkeeping and financial calculations, and you do not really care if it will actually prepare your tax return, Hometax Plus has these features.

Both Cantax and Hometax Plus have a tax-planning module that can be used throughout the year to insure that there are no surprises when tax time comes around again. Neither of them have a state-of-the-art user interface. However, when you look at tax software, you will find most packages have a cumbersome user interface.

Cantax is still much easier to use; I was able to prepare my tax return with very little confusion the first time out with Cantax. When I attempted to use Hometax Plus, not only was I confused by the approach, but windows were constantly popping out from everywhere.

Considering the fact that this is Informatrix 2000's first stab at personal tax preparation software, I would not write the package off completely, and I look forward to seeing some real competition to Cantax next year. For tax return preparation, Cantax is still the number-one choice.

One thing in closing: it is well worth the investment in tax preparation software to ease the pain of preparing your tax return.

Hear Ye! Hear Ye!

Reach across to Vancouver Island each and every week!

Introducing **VICTORIA & Island BUY & SELL FREE AD MART**

Launch issue on sale February 7, 1991 at over 700 newsstands in Victoria and throughout Vancouver Island.

A new publication from the Buy & Sell Press Ltd. ...opening up a new marketplace for our advertisers.

In Victoria: call **361-1222**
In Vancouver: call **273-1571**

Book space NOW!

The Booksellers' BEST SELLERS

TITLE	AUTHOR	PUBLISHER	PRICE
AMIGA			
Amiga DOS Inside & Out	Spanick	Abacus	\$25.95
Mapping the Amiga	Anderson	Compute	\$28.95
DATABASE			
Understanding dBase IV version 1.1	Jones	McGraw Hill	\$33.95
Liskin's dBase IV Publishing	Liskin	McGraw Hill	\$39.95
DESKTOP PUBLISHING			
Desktop Publishing by Design	Microsoft	Microsoft Press	\$27.95
Looking Good in Print 2nd Ed.	Parker	Ventana Press	\$30.95
DOS			
Running MS DOS	Wolverton	Microsoft Press	\$31.95
Quick Reference MS DOS	Que	Que	\$8.95
NETWORKING			
Network User's Guide	Liebing	M&T	\$31.95
Mastering Novell Netware	Listed	Sybox	Listed
MACINTOSH			
Mac Bible "What do I do now?" Book	Rubin	Goldstein-Blair	\$15.95
Mac Bible 3rd Ed.	Naiman	Goldstein-Blair	\$37.95
SPREADSHEETS			
Using 1-2-3 Rel. 2.2 Special Edition	Que	Que	\$34.95
Quick Ref. 1-2-3 Rel. 2.2	Que	Que	\$9.95
WORD PROCESSING			
Mastering WordPerfect 5.1	Simpson	Sybox	\$31.95
Using WordPerfect 5.1	Que	Que	\$31.95

This List is sponsored by B.C.'s largest retailers of Computer Books

Cody's Westwood Mall 2-3000 Lougheed Hwy., Coquitlam 464-5515

SuperSoftware Inc. 103 4600 #3 Road, Richmond B.C. V6X 2C2 (604) 278-7638

PEEP COMPUTER SYSTEMS LTD.

COME SEE THE NEW 386/20 WITH 16K CACHE, LANDMARK SPEED 29MHz

28612MHz \$899	28616MHz \$959	386SX-16/20 \$1299	38625 \$1589	386-33 MHz 64K \$1869
--------------------------	--------------------------	------------------------------	------------------------	---------------------------------

COMPUTER SYSTEM INCLUDES:

- 1 MB RAM, 0 wait state
- 200 watt power supply, CSA approved
- 1.2 meg or 1.44 meg floppy drive
- serial, parallel & game ports
- 101 key enhanced and tactile keyboard

42 MB HARD DRIVE

- Miniscribe 28ms
- 2 year warranty
- 1-1 AT IDE Controller

HI-RES MONITOR

- 12" Amber screen, mono graphics card

4319 Fraser St., Vancouver
872-7337 HOURS: Mon.-Sat. 10 A.M. - 6 P.M.

ESDI Drives

- High Performance Hard Disk Drives
- Ideal for server applications of Novell, Xenix, Unix, 3Com

Match with the perfect controller

MAGTRON

ULTRASTOR CONTROLLERS

Dealer Inquiries Welcome

Dealer inquiries welcome

ComStar Distributors

Unit 368-13988 Cambie Rd., Richmond, B.C. Canada V6V 2K4 • Phone (604) 279-0188 • Fax (604) 279-0288

Apple Macintosh™ the leader in ease-of-use and productivity for in-house publishers . . .

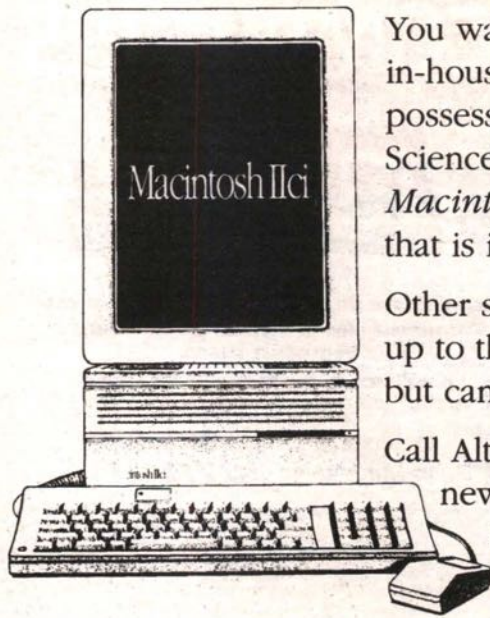

You want to automate your in-house publishing but don't possess a PhD in Computer Science. The obvious choice is a *Macintosh™* system with software that is intuitively easy to use.

Other systems are trying to catch up to the *Macintosh™* ease-of-use but can you afford to wait?

Call Altext today to see how the new lower cost *Macintosh™* Classic or Mac IIsi can benefit your business.

We employ qualified and experienced Apple Systems Support personnel. Prices are *guaranteed* to be the lowest in the lower Mainland.

ALTEXT

CONVERSIONS INC.

105A-1675 West Eighth Ave.
Vancouver, BC V6J 1V2
Phone: 732-1416 Fax: 738-0840
VoiceFax: 222-8444 (two lines)

Apple, the Apple logo, are registered trademarks of Apple Computer, Inc. Macintosh is a registered trademark of Apple Computer, Inc. Altext Conversions Inc. is not an authorized Apple dealer.

DATATRONIC COMPUTER & NETWORKING

3328 Fraser Street, Vancouver, B.C. V5V 4C1
Tel: (604) 872-8468 Fax: (604) 872-8469



Office Hours: 10:00 a.m. to 5:00 p.m. (Mon. - Thur.)
10:00 a.m. to 8:00 p.m. (Fri.)
10:00 a.m. to 5:00 p.m. (Sat.)
12:00 p.m. to 5:00 p.m. (Sun.)

286-12MHz \$868

• expandable to 4MB RAM

VGA Upgrade \$1098

• Samtron 14" 640 x 480 .41mm
• VGA graphics card

386SX-16MHz \$1199

• expandable to 8MB RAM

VGA upgrade \$1439

386-33MHz \$1749

• expandable to 16MB RAM
• 64K Cache on board

VGA upgrade \$1989

486-25MHz \$2949

• expandable to 16MB RAM
• 128K Cache included
• 4MB RAM

VGA upgrade \$3189

System Configuration:

- 1 Mbyte RAM (except 486 systems)
- 1 Parallel / 1 Serial / 1 Game Ports
- IDE hard/floppy drive controller
- Maxtor 40MB IDE hard drive
- 1.2MB 5.25" floppy drive
- Mono graphics/printer card
- Hercules Hi-Res 12" monitor
- AT 101-key Tactile keyboard

Super-Sync VGA upgrade

- TVM 2A 14" 800 x 600 .31mm
- Trident VGA card w/256K expandable to 1MB

\$419

Citizen 200GX Printer

- 9-pin dot-matrix
- Color printing (optional)

\$229

**Two Years Warranty (Above Systems) &
Two Years Manufacturer Co-Warranty**

SPREADSHEETS

Spreadsheets for the Mac, Amiga, Atari, NeXT

by Graeme Bennett

Just as the PC arena is the spreadsheet battleground, so the other platforms are often the proving grounds for new twists on the electronic worksheet. Here are some of the frontrunners, with brief descriptions of the features that make them stand out.

Macintosh

The Macintosh spreadsheet market is an area overwhelmingly dominated by Microsoft's Excel, which is said to command nearly 90% of total sales. But is it the best? Strong contention is now coming from Wingz and Full Impact. (We will review Full Impact in a coming edition of The Computer Paper)

Amiga

In the opinion of Gene Endrody of Conti Computers in Vancouver, there is only one clear Amiga spreadsheet standout: Advantage, with a street price of C\$240. Taking, er, advantage of the Amiga's multitasking graphical environment, it's by well-known Canadian software publisher Gold Disk. It was also named by several other sources.

Other titles mentioned when dealers were asked to name the best spreadsheet available for Amiga computers were Superplan by Precision Software, recommended by Nu-Tek Computers; and Maxiplan by Oxxi (formerly published by the now-defunct Aegis Development), the choice of Sprite Computers.

Atari ST/TT

The \$249 LDW Power by Logical Design Works is a bigger seller, and has more bells and whistles, but the best for the ST is Analyze, says Darrell Johansen of Wizard Computers. Like LDW Power, Analyze reads/writes 1-2-3 files, and offers charting features. He says it is the fastest for the ST.

Ron Grant of GXR Systems prefers LDW. Now at version 2.00, it sports a nifty feature similar to one available in Word 4.0 for the Mac. Any of its commands or options can be added or removed from the program's menus, allowing users to craft their own look and feel—lean and mean, or bloated with options.

The new version 2.0 of LDW Power comes with a 68-page "Addendum #1" that covers all of the changes made to LDW Power in versions 1.10 and 2.00.

LDW Power 2.00 has been expanded to support the extended macro command set of Lotus 1-2-3, V. 2.01, that's all. It does not claim to run all Lotus 2.2 macros. Many of the new commands involve window management, or support the new Graphics Editor included now in LDW Power 2.00.

LDW Power 2.00 appears to be bug-free. A bug in the previous V. 1.10 occurred when your cursor rested in a column on the far right of your screen and you executed a /Range Erase. (Insert) (Down) command. The screen became confused and displayed a different section of the worksheet than the one you were working on. This bug no longer exists in V. 2.00.

NeXT

People from NeXT Inc. are knocking on the doors of the Fortune 500 companies these days, showing off what they say is a program so great, it's worth buying a NeXT just to run it. And they may be right.

NeXT is capitalizing on the fact that Lotus Corp. has chosen its platform to develop and release Improv, a spreadsheet *Byte* magazine's Oct. '90 issue called, "stunning...a spreadsheet for the nineties." At the NeXTstation introduction (a video of which was seen by thousands of attendees at the NeXT booth at the recent Pacific Rim Computer & Communication Show), Lotus chief Jim Manzi claimed that they simply couldn't have made Improv as good as it is on any other platform.

Indeed, running on the NeXT, Improv inherits its host's elegant user interface, virtual memory, transparent networking and multitasking abilities. Although even that would set it apart from most others, Improv goes much further.

All hyperbole aside, Improv manages to strike a balance between the elegant simplicity that is the hallmark of any "killer app," while proving remarkably capable. As you might expect from the company that produced the spreadsheet of the eighties (1-2-3, for those of you that spent the decade in a cave), it reads and writes 1-2-3 files, while literally reinventing the whole spreadsheet metaphor, using named cells instead of rows and columns of numbers and letters.

An innovative system of re-arranging the display to see different relationships in the data makes it truly—no pun intended—a next-generation product, more powerful than any other spreadsheet on the market, period. Priced at US\$695, Improv is bundled free with new NeXT systems until March 31, 1991.

Ashton-Tate's PowerStep is a more traditional spreadsheet implementation, offering 1-2-3 file compatibility and the same interactive rotation of 3-D graphs found in the company's Full Impact product for the Macintosh. Like most other good NeXT apps, it allows the inclusion of voice annotations for those who want to let the numbers literally speak for themselves.

Informix's Wingz, now available on Mac, Windows and Unix platforms has also come to the NeXT. Wingz produces the best charts of the three programs, and also offers the best custom-application programming and macro language capabilities. Using its integral HyperScript language, users can completely control how Wingz looks and behaves. An expert user can build an application environment that includes controls such as radio buttons, pop-up menus, slide bars, check boxes and custom buttons. In short, Wingz—like the NeXT—is an application developer's dream.

Thanks

While researching this article, I used a combination of techniques for determining the most popular software titles: anonymous phone calls to local dealers; perusals of reviews; personal experience; and national statistics. Thanks to all dealers and users, special thanks to Darek Mihocka and Mike Squire for their comments on GENie and in *ST Report* (Jan. 18, 1991, No. 7.03).

SPREADSHEETS

Lotus Improv— The Spreadsheet Re-defined

	1991	1992	1993
Sales	1,473	1,500	1,550
Cost of Goods	280	280	280
Expenses	450	450	450
Total Expenses	730	730	730
Net Income	743	770	770
Sales	2,000	2,000	2,000
Cost of Goods	400	400	400
Expenses	800	800	800
Total Expenses	1,200	1,200	1,200
Net Income	800	800	800

By moving a category of information from here... to here, Improv restructures your spreadsheet, automatically.

	1991	1992	1993
Sales	1,473	1,500	1,550
Cost of Goods	280	280	280
Expenses	450	450	450
Total Expenses	730	730	730
Net Income	743	770	770
Sales	2,000	2,000	2,000
Cost of Goods	400	400	400
Expenses	800	800	800
Total Expenses	1,200	1,200	1,200
Net Income	800	800	800

Product: Improv 1.0
Publisher: Lotus Development Corp.
System Requirements: NeXT computer

Price: US\$695, bundled free with new NeXT systems until Mar. 31, 1991

by William Barr

After you have had a chance to use Lotus Improv on the NeXT, you will wonder why you use another spreadsheet.

3-D Glasses Required

Upon seeing the program in action, it is easy to believe that Lotus has designed a CAD program for manipulating numbers. Any spreadsheet becomes a 2- or 3-dimensional image that you can manipulate like a drawing. It's quite a different way of looking at numbers.

Lotus quickly became a victim of its own success. The financial and accounting community were drawn to 1-2-3 like moths to an open flame. One might even say that 1-2-3 gave the IBM-PC its *raison d'etre*.

Lotus found that with such a large user base, modifications beyond the basic design became difficult to do because later releases had to be compatible with previous versions. So, for a number of years, it has been trying to build a better spreadsheet. (Rumor has it that a development team spent several years working on a version of Improv, originally for OS/2, but it never came together.) When Steve Jobs paid a visit to Lotus, the developers found a machine for Improv.

At first glance, Improv looks like any other spreadsheet. Rows and columns of cells appear as in Excel or Wingz. The basic functions of all other spreadsheets are there as well, formula editing, script-building and programmability are all included along with the basic calculating abilities. You can build either 2- or 3-dimensional models. But you have to look a little harder to see what's under the hood.

Improved Look

The first difference that you will notice is the look of Improv. This is due to the NeXTStep graphic user interface. NeXTStep also lets you to paste in sound, voice mail, and graphics directly into a spreadsheet document. This makes possible true multi-media presentations of data. Since NeXTStep uses Display PostScript, what you see on the screen is truly what comes out of the laser printer.

Getting started on Improv is easy. Since it imports documents in the "wks" format, no re-entering of existing data is needed. Unlike more neolithic spreadsheets, which have numbered rows and lettered columns, Improv prefers to use English. Rows and numbers are named by you.

While you are designing your spread-

sheet, these labels retain their integrity and remain related to the data they represent. For example, if you delete column "B," column "C" isn't renamed "B," "D" isn't renamed "C" and so on. Instead, labels identify groups of data.

Logically, formulas also appear in English. For those of you who are used to "E25=SUM(A25..D25)," Improv shows the same formula as "Annual Gross Profit = groupsum(Sales)".

Since cells are "objects," you can easily cut-and-paste entire sections of a spreadsheet without having to re-enter data or edit formulas. In addition to a general formula applying to a group of numbers, any individual cell can have its own unique formula within a general formula. This allows you to work with anomalies in data, easily.

However, you can spend hours designing the world's best spreadsheet and not have it understood. Lotus believes in the sage who stated a picture is worth a thousand words.

A variety of 2-D and 3-D charts/graphs are available for your use.

Since the graph is dynamically linked with the document, any change made in the spreadsheet is instantly reflected in the graph. Legends and labels are automatically generated, and axes are easily interchanged. As stated before, you can even incorporate sound in your desktop presentation.

Unix Advantages

In its overall presentation, Improv takes full advantage of the NeXT. Since this is a Unix box, it is possible to collect data using a background program and build a spreadsheet using that data, simultaneously.

The 17-inch display easily accommodates Improv's ability to display several worksheets, graphs and close-ups of worksheet sections. It is also possible to link data in one spreadsheet with any other spreadsheet (on disk) using dynamic data links. Anyhow, this may all seem nice, but I haven't even reached the good part yet.

What sets Improv apart from other spreadsheets is the manner in which you can manipulate data. (see screen shots above)

Using an object-oriented approach to spreadsheets enabled Lotus to give you a powerful analytical tool. Instead of using a fixed grid-reference of traditional spreadsheets, this new model lets you concentrate on the task at hand instead of spreadsheet design. Now you know what to spend your budget surplus on.

ALLIANCE BUSINESS COMPUTERS

341-G NORTH RD., COQUITLAM, B.C. V3K 3V8
 PHONE: 936-8088 OR BY 80486 FAX: 936-7483

STORE HOURS: MON. - WED. 9-6, THUR. - FRI. 9-9, SAT. 10-5

Sweetheart Systems

- 486-25** with 1.2 floppy, 85MB HD, 18ms, Mono Monitor, Keyboard, 1MB RAM**\$2997**
- 386-33** with 64K Cache, 1MB RAM, 40MB HD, Super VGA 10 x 4 x 768, 1.2MB Floppy**\$2097**
- 386SX** with 1.2 & 40MB paperwhite VGA, 1MB RAM**\$1197**
- 286-20** 1MB RAM, 40MB HD, 1.2MB Floppy, 640 x 480 VGA Colour**\$1297**
- 286-12** 1MB RAM, 40MB HD, 1.2MB Floppy, Mono Card & Monitor**\$797**
- Notebook** Laptop VGA 40MB HD, 1.44MB Floppy**\$2997**

Specials

- HP Laserjet III**\$1997**
- HP Deskjet 500**\$697**
- Panasonic 4450 Laser**\$1797**
- Panasonic 1124**\$399**
- Logitech S9 Mouse**\$77**
- BTC Cordless Mouse**\$77**
- 1.4 Disks**\$1.77**
- 1.2 Disks**\$0.77**
- Seiko 1450**\$897**
- 1MB VGA Cards**from \$177**
- Sound Blaster**\$207**

Motherboards

- 286-20**\$199**
- 286-12**\$119**
- 386SX-16**\$499**
- 386SX-20**\$597**
- 386-25**\$787**
- 386-25 Cache**\$897**
- 486-25**\$2097**

Hard Drives

- Kalok 40 IDE**\$267**
- Seagate 40 IDE**\$277**
- Seagate 85**\$547**
- Mitsubishi 535, 40**\$337**
- Miniscribe 40**\$307**
- Rodime 80**\$587**
- Rodime 112**\$677**
- Rodime 200**\$1137**
- Fujitsu 330MB**\$1477**
- Fujitsu 660MB**\$2177**

Controllers

- IDE Host Adapter**\$37**
- SCSI Future Domain**\$177**
- RLL Kimsion**\$117**
- ESDI NCL**\$227**
- ESDI Ultrastor**\$237**

Keyboards

- Axus**\$57**
- Tangent**\$57**
- Focus 2001, 3001, 5001**\$77 / 107 / 137**
- Maxiswitch Memory Pro**\$247**
- Barcode Reader**\$347**

Modems

- 2400 int**\$97**
- 2400 ext**\$127**
- 9600 baud**\$777**
- 9600 S/R Fax**\$427**

Networks

- ReadyLink**from \$407**
- PowerLan**From \$777**

Monitors

- Everdata 640 x 480**\$377**
- Everdata 1024 x 768**\$447**
- Monochrome Trisync**\$107**
- Seiko 1440**\$717**
- Seiko 1450**\$937**
- Seiko 2050**\$2477**
- NEC 3D**\$877**
- NEC 4D**\$1797**
- TVM 3A**\$597**
- Mitsubishi 20"**\$2197/2397**

CoPros & RAM

- RAM**\$89/MB**
- 287-10**\$167**
- 387-25 Cyrix**\$497**
- 387-33 Cyrix**\$597**

Desks

- 4 piece deluxe**\$267**
- 3 piece economy**\$117**
- 2 piece student**\$87**

Software

- DOS 4.01 or 3.3**\$77**
- Games**\$19 - \$59**
- PC-Sell**\$297**
- Business Vision**\$357**
- Home Tax+ for personal tax**\$37**

COMPUTER CLEARANCE ON

- XT's Turbo 640 with 360K floppy, mono card & monitor**\$347**
- DOS 3.2**\$47**

CUSTOM BUILT SYSTEMS

Software B.C.

LET'S PROFIT TOGETHER

We want you to profit from membership in our organization

BENEFITS

- Keep in touch with Canada's largest software industry
- Learn from professionals in the field at monthly meetings
- Expand your audience and contacts

WHO JOINS

- Software developers
- Large multi-purpose firms
- Service companies
- Any group interested in contributing to the software industry.

How to Join:

Write or Call Software B.C. at:
500 - 1190 Melville Street, Vancouver, B.C. V6E 3W1 (604) 682-2034

SOFTWARE BC'S UPCOMING MEETING

Benedict's Restaurant
1177 W. Pender

Doors open at 5:30 p.m.,
Buffet dinner at 6:30 p.m.
Guest speaker at 7:00 p.m.

\$25 members;
\$40 non-members

FEBRUARY 21
MARKETING SOFTWARE
IN EUROPE.

Michael Marckwort
Michael Marckwort & Assoc.



SHAREWARE AND PUBLIC DOMAIN SOFTWARE (604) 854-DISK

IBM PC COMPATIBLE PROGRAMS

NEW ADDITIONS

SCS #1A - PRINTPARTNER V1.0
PrintMaster Plus clone makes signs, banners, and calendars with a variety of graphics and fonts. Supports most dot matrix printers. Converts PrintMaster graphics to PrintPartner.

SCS #23A - BATTLE FLEET
V2.3 EGA/VGA Version of Battleship. There are 10 levels of difficulty against the computer and a version to play via a modem.

SCS #24A - DINO PICTURE
V2.1 Dinosaur educational game telling common and scientific names, family, habitat and time period map. Print dinosaurs. Req. CGA.

SCS #41A - MELODY MASTER
V1.5 A one-voice music editor lets you edit notes on a staff and output the finished song in a format that can be played on a PC's speaker or translated for use by Pascal, C, or Basic. A collection of music files is included.

SCS #49A - LAST HALF OF DARKNESS
EGA Graphic adventure. Your strange aunt has died leaving you the soul survivor of her estate, if you continue working on a powerful magic potion she invented. Search the creepy old house for ingredients for the potion. Supports Covox Speech Thing and req. 512K, hard disk and EGA.

SCS #60A - INTEXT
V1.2 A Multi-lingual full featured word processor. Supports Arabic, Farsi, Gaelic, Greek, Hebrew, Polish, Russian, Turkish, Urdu, Yugoslav, and English. Prints charts for each language showing corresponding English characters. Displays all the special characters of these languages and prints to Epsom FX, LQ, or IBM Proprinter.

SCS #82A - ELECTRONIC CATALOG
SYSTEM Build an electronic catalog/ordering system on a floppy disk. The Kit creates a stand-alone program with your company name and a database of products and descriptions which you have entered. Customers browse through a list of products, access additional info, enter a quantity, and the price including sales tax will be displayed. Order forms can then be printed.

SCS #83A - ELECTRIC ALMANAC
Electronic form of the classic farm almanac. determine best fishing times, star watching, planetary hours tables and much more. Also included are daily astrological interpretations, tarot card spread, I Ching, and lottery options.

SCS #107A,108A - AUTORENDER
V2.1 A DXF rendering and shading program. Ten basic commands include turning, zooming, colouring, redrawing, and print options. Supports mouse. Documentation describes each process and 3-D rendering. Req. hard disk and 640K.

SCS #113A - VINO:FILE
V2.15 Manage your wine cellar and tasting notes. Maintain inventory, location, variety, year, category and more. -ASP-

SCS #117A - VIEW IMAGE
V2.62 Display GIF and TIFF files, zoom, pan and print. Menu Driven. Supports almost ALL video displays and Epsom, LaserJet printers.

SCS #119A - X-LOCK 1
V2.14 Software based PC Security with access control. Password identification is required to protect against intruders. Will not permit Hard Disk access from a floppy disk boot.

SCS #126A - FOLDER SYSTEM
Create information folders for your wordprocessor describing the contents of each file/letter. Supports PC-Write, Galaxy, WordPerfect, MS Word. No more wondering what the scrambled 8 character DOS filename really denotes.

SCS #127A - WALL STREET
THE BOTTOM LINE
V3.55 Track investments in the stock & bonds market. Store each transaction to provide complete information on your holdings. View as a chart or graph.

SCS #151A - SCHOOL MOM
V3.56 For kids of all ages. 3 levels of music composition, 5 Art options supporting mouse & joystick, 3 levels of English teaching nouns, verbs, adjectives, sentence structure and more, 4 levels of Spelling, Math, preschool counting, and a time teaching program. Req. CGA & 256K RAM.

SCS #152A - FLU SHOT +
V1.81 Protect your software against Viruses and Trojans. Menu Driven. Instant alert when a virus becomes active or attempts to invade a program. -ASP-

UPDATES

SCS #46C - M-LABEL

SCS #51A - AUTOMENU

SCS #56B - DRAFT CHOICE

SCS #70B - BENCHMARK

SCS #185A - BURN-IN

SCS #293A - TREEVIEW

SCS #362B - TEXTCON

SCS #369B - CLICHE FINDER

SCS #371A,372A,373A - CREATIVITY
PACKAGE

SCS #430A,431A - KWIKSTAT

SCS #432A - LOTTO PROPHET V3.0

SCS #434A - AMPLE NOTICE

SCS #436A - LQ

SCS #437B - QANALYST

SCS #438B - 4DOS

SCS #491C - GALAXY LITE

SCS #496B - BOOK OF CHANGES

SCS #500A - VIDEOCAT

SCS #598B,599B,632B - WINDOW BOSS

SCS #605B - BOWL 1011

SCS #611A,612A - PROPAP

PRICE PER DISK*

Members \$4.95, NON-Members \$6.95
+ \$0.50 per disk S & H - MIN \$1.00 -
and 6% PST - Add \$1.00 for 3.5" format
HD Disks - \$10.95 for Members,
\$12.95 for Non-Members.

Introductory special

Any 5 SIM-COM disks and membership
for \$34.95 (+ \$3.00 S & H and 7% GST
and 6% PST - TOTAL \$42.71)
Each HD Disk counts as 2 Disks!

*These are SHAREWARE Disks. Use
of Shareware disks beyond a reasonable
evaluation period, may require separate
payment to authors. Please respect
author's rights as outlined on each disk.

-ASP- Denotes Association of
Shareware Professionals author
CDN Denotes Canadian Author
SIM-COM Services
35158 High Drive
Abbotsford, BC V2S 4P6

MAC WORLD EXPO

Show Report

MacWorld Expo Opens

SAN FRANCISCO, CALIFORNIA, JAN 7 (NB)—The Macintosh clan gathers this week in San Francisco for its semi-annual MacWorld Expo, amid the standard set of rumors but few confirmed major announcements.

This Expo will be the last before Apple is supposed to ship its System 7 operating system, which is expected in the first half of this year. While developers have been seeded with the new system software, they are prohibited from displaying it publically. As a result, no System 7-specific software is expected to be shown this week.

After being moved last year to April, Expo returns to its normal January slot. The show runs from Thursday afternoon through Sunday, at the Moscone Center and the San Francisco Civic Center/Brooks Hall.

Microsoft has planned a news conference during the show, at which it is expected to unveil version 3.0 of its market-leading Excel spreadsheet. Few new functions are expected, with most of the changes to be improvements in the user interface. Lotus's long-planned Mac version of 1-2-3 remains AWOL.

All sorts of rumors also are swirling around Apple (as usual). Among the new hardware that may or may not be announced are a slightly enhanced Portable and a new mid-range printer to replace the disliked and bug-ridden

Imagewriter LQ.

CE Software, publishers of Quickmail and QuicKeys, has scheduled a news conference and first meeting of its users' group. Rumors have it that the company will tell the press and loyalists of its plans for System 7-specific software.

Published reports say several companies will show new music and sound tools. Also to be demonstrated are accelerator cards based on the latest in the 68000 chip family, the 68040—despite the fact that Motorola isn't shipping the 68040 in quantity yet.

Reporter's Notebook: MacWorld Expo

SAN FRANCISCO, CALIFORNIA, JAN 15 (NB)—After a big meal, it's not unusual for people to sit around quietly, digesting. Maybe they have a brandy or two. That's sort of what MacWorld Expo was like this year.

The Mac community has lots to work on. Last year's wave of platforms has given rise to incremental improvements like video displays for the Mac IIsi or voice annotation of documents, relying on programming first seen in Apple's latest upgrade of system software. There's still talk of System 7, but almost no evidence of it on the show floor. Developers are talking about the millions of Classics Apple is about to sell, but no one's talking about new low-end applications for them.

Most exciting products to this reporter's eyes—and these are slim pickings indeed—were the Sony VBOX,

SLIDES FROM YOUR IBM PC OR MACINTOSH®

682-4686

FINALLY a super high resolution GENIGRAPHICS service bureau specializing in POWERPOINT® and many other popular software programs.

IBM COMPATIBLE

- HARVARD GRAPHICS
- LOTUS FREELANCE
- ZENOGRAPHICS

WINDOWS

- POWERPOINT
- CORELDRAW
- WINDOWS
- METAFILES

MACINTOSH

- POWERPOINT
- PERSUASION
- CRICKET PRESENTS

— AND MANY MORE! —

Full colour slides, overheads, and hardcopy. 24 hr turnaround, plus custom design and production. 8000 line resolution.

VISION:

Presentations Inc.

Vision Presentations Inc. 200-1380 Burrard Street, Vancouver V6Z 2H9
(604) 682-4686 FAX (604) 682-0792

Association of Shareware Professionals - Vendor Member

Authorized SIM-COM Services' Dealers

Super-Byte Computers
Maple Ridge 463-8733

Vancouver Shareware
Van/S.Delta 688-1127

DEALER INQUIRIES WELCOME

which promises to let people control video devices the way they control printers or disk drives, and WordPerfect 2.0. The former won't be available for a couple of months. The latter, expected for nearly two years, is suddenly shipping—suddenly, because the company didn't provide much warning that the thing was as close to shipping as it appeared to be.

Lawyers have long known to argue justice if the facts are against them. On the same principle, perhaps, this was the busiest party Expo in recent memory. Friday night, the big night, there were no fewer than eight bashes—many of them simultaneous and most of them major. In keeping with Expo tradition, however, several didn't start until East Coast visitors suffering from jet lag would long since have turned into pumpkins. Not that most people were stopped...

In keeping with that, the January Expo appears to be increasingly geared to the general public, rather than a specific trade audience. The show started at 3 pm on Thursday and ran that night until 9—presumably so people could stop by after work. The show was open over the weekend, too, so the only day dedicated to professional showgoers was Friday. Given the costs of displaying at a show like Expo, and given that a walk-in audience is likely to have less influence than one that travels and dedicates several days to it, one wonders if the attendees were all that exhibitors would have wanted.

Big crowds: Aldus, Adobe, Apple, WordPerfect, EduCorp (showing a new not-yet-released CD-ROM-based game from Reactor with terrific graphics), and Microsoft. Microsoft usually has big crowds; this time, they were drawing them with Excel 3.0. That's a DOS product, folks.

ON Technology's Meeting Maker

CAMBRIDGE, MASSACHUSETTS, JAN 7 (NB)—ON Technology, headed by former Lotus chief Mitch Kapor, has announced its second product: software that lets users coordinate their calendars to set up meetings.

Meeting Maker is slated to ship in the first quarter of this year for a retail price of \$495 for five users or \$895 for 10 users.

The program, according to the company, will let users propose meeting times to other users or will automatically find the first open time slot for everyone invited to meet. Users can also use Meeting Maker to maintain their to-do lists and personal schedules, blocking out time and setting up recurring appointments. Contact: ON, 617-876-0900.

Read My Lips

YPSILANTI, MICHIGAN, JAN 7 (NB)—Sound annotation of Macintosh documents is now possible with a new package from Praxitel. *Read My Lips* lets users attach either existing or newly recorded sound files to documents created by several popular applications.

The program, the company said, works with MacWrite, MacWrite II, Microsoft Word, Nisus, WordPerfect, Aldus Pagemaker and Microsoft PowerPoint. Users can attach sounds in "snd" or AIFF formats, or can record sounds with the Farallon MacRecorder or microphones built into the Macintosh LC or IIsi.

The program lists for \$119, and is available immediately. A play-only ver-

sion may be distributed freely, the company said.

Contact: Praxitel, 313-485-6278.

Ethernet Cards from Apple.

CUPERTINO, CALIFORNIA, JAN 8 (NB)—Apple Computer has announced a new line of circuit cards that let most expandable Macintoshes be hooked directly into high-speed Ethernet networks.

The new cards include models for the newly shipping Macintosh LC and another that will fit all models in the Macintosh II series. Apple said third parties will be making cards for other Macintoshes, including the Classic.

Prices and availability for the new products were not announced.

The new products appear to replace the Apple EtherTalk NB Card, which directly supported only thin coax connections. Other media could be connected only through external transceivers.

More Ethernet Adapters

SANTA CLARA, CALIFORNIA, JAN 16 (NB)—National Semiconductor has introduced three adapter cards that connect Apple Macintosh computers to 10BaseT (twisted-pair) Ethernet local area networks. Asante Technologies, meanwhile, offers a line of Ethernet adapters for the Macintosh IIsi and Classic.

The National Semi boards incorporate connectors for both thick coax and twisted-pair Ethernet. They also feature drivers that are fully compatible with Apple's Ethernet protocol, called EtherTalk. All three boards utilize National Semiconductor's Ethernet LAN chip technology.

EtherNODE-16NB-TP is a 16-bit NuBus adapter for all models of the Macintosh II; EtherNODE-16SE-TP is a 16-bit board for the Macintosh SE expansion slot; EtherNODE-32SE/30-TP is a 32-bit DMA (direct memory access) board for the Macintosh SE/30 processor-direct slot (PDS).

Asante, of Sunnyvale, California, says its Ethernet card for the Macintosh IIsi is the smallest on the market. The MacCon+30i fits into the machine's Direct Slot 030 bus. For the Macintosh Classic, there's the EN/SC external SCSI box which provides Ethernet support through the Classic's SCSI port. The device has thick, thin, and twisted-pair connections.

The MacCon+30i comes in two versions, each \$495, and the EN/SC is \$595. Contact: National Semi; Asante Technologies, 415-864-5600; fax 415-552-5738.

Apple Upgrades Fax Software With BackFax

SAN FRANCISCO, CALIFORNIA, JAN 11 (NB)—Apple Computer will sell owners of its AppleFax modems an upgrade to what had been the company's biggest competitor: BackFax, from Solutions Inc.

For \$35, owners of the AppleFax modems will be able to order a copy of the \$245 BackFax, said officials of Apple and Solutions Inc. BackFax lets users send and receive faxes in the background, without requiring them to give up use of their machines.

AppleFax owners who already own BackFax will qualify for a coupon good for \$75 rebates on other Solutions products. Contact: Apple, 408-974-5453.

NEWTECH COMPUTER LTD.

428 Dunlevy St., Vancouver
Tel. 251-3309

SHOPPING HOURS: Mon. - Thurs. 12:30pm - 8:00pm Fri. 12:30-6pm Sat. - Sun. 1:00pm - 6:00pm

EXCELLENT PRICE, QUALITY, SERVICE (WELCOME TO COMPARE)

System Sales: Special Price & Special Service

(Included FREE: Training + Installation + Delivery)

Systems

	BASE	COMPLETE
80286 8/12 MHz (Exp. 4 MB)	\$449	\$812
80286 8/16 MHz (Exp. 4 MB)	\$492	\$899
80386 16 MHz (Exp. 8 MB)	\$818	\$1224
80386 20 MHz (Exp. 8 MB)	\$925	\$1339
80386 25 MHz (Exp. 8 MB)	\$1069	\$1483
80386 33 MHz (Exp. 8 MB)	\$1353	\$1767
80486 25 MHz (Exp. 8 MB)	\$2371	\$2786

All Base Systems Include:

- 1MB DRAM/SIMM (SIPP) on Board
- TEAC 1.2MB 5.25" Floppy Drive
- AT Multi I/O Card (IS, IP, IG)
- 101 Enhanced Tactile Keyboard
- Small Footprint Cases w/200W Power Supply
- AMI BIOS (G2 w/AWARD)
- Clock
- CSA Approved
- Fully Assembled and Tested
- 1 YEAR WARRANTY (Labour & Parts)

Complete Systems

Include Base Systems PLUS:

- IDE Host Adapter with Cable
- Western Digital 93044 40MB 28ms IDE Drive
- Monochrome/Printer Port Video Card
- 12" Hi-Resolution Amber Monitor

To UPGRADE to SUPER VGA add \$384

PAL OAK 16 Bit VGA Card w/512K (1024x768)
LEGEND 14" VGA Monitor (.28 dot pitch, 1024x800)

Prices subject to change without notice

We have quality brands and special prices on systems, monitors, hard drives, floppy drives, printers, cases, co-processors, faxes, video cards, keyboards, motherboards, memory, modems, mice, power supplies, controller cards, cables, tape backups, accessories, and software. Such as:

Hard Drives

WD 40MB 28ms	\$274
IDE host adaptor	\$22
Rodime 84MB 3.5" 25ms	\$537
Maxtor 80MB	\$513

Floppy Drives

Teac 1.2MB 5.25"	\$77
Teac 1.44MB 3.5"	\$71

Monitors

Calcomp TTL 14" flat screen w/T&S	\$130
12" MM213 VGA Mono (P/W)	\$115
Goldstar 12" amber monitor	\$91
AAmazing 1288 12" mono, amber, TTL	\$120
Legend 14" VGA plus color (.28, 1024X768)	\$397
+ 16bit VGA w/512K (1024X768)	\$103
Qume QM-835 14" super VGA (.28, 1024X768)	\$451
Morse 14" VGA (.28, 1024 x 768)	\$451
+ 16bit VGA w/512K (1024X768)	\$102

Printers

Fujitsu DL3400 24-pin	\$479
Panasonic KXP-1180 9-pin	\$184
Panasonic 1124 24-pin	\$348

Mouse

BMC infrared cordless mouse	\$63
A-Tech serial (3-Button)	\$26
IMS Mouse w/Turbo CAD	\$70

We are computer brokers and offer many items at special prices. Call to check prices after you decide to buy an item. We also have quantity discounts.

Support Services:

Training, Installation and Custom Programming (Novell, C, dBASE, Clipper, Lotus 1-2-3) for small/medium business.

ACCOUNTING SOFTWARE

NEW VIEWS
The Visual Approach to Accounting



**AUTHORIZED
Master Dealer
Certified Consultant
Training Centre**

Serving B.C. since 87

Call: 322-6198

**SALES
SUPPORT
TRAINING
FREE SEMINAR**

**Local Area Network
Custom Programming
Data Recovery**

TXL Management Systems, Inc.

6528A Victoria Drive
Vancouver, B.C. V5P 3X9

NORTHWEST INFORMATION SYSTEMS

CORPORATE GOVERNMENT ACCOUNTS

HARDWARE DataTrain

DATATRIN 3016-386SX	\$1973	AIR 386/25MHz	\$3489
DATATRIN 3325-25MHz	\$3654	AIR 486/33MHz	\$5665
DATATRIN FAX	\$775	AIR 486/25MHz	\$5265
NEAT 386sx	\$1398	MITSUBISHI LAPTOP	\$2288
NEAT 25MHz	\$1825	INTRA LAPTOP 386sx	\$3695
DTK 386SX	\$1794	TOSHIBA T1000XP	\$2298
DTK 386 25MHz	\$2550	TOSHIBA T1600	\$3848

DRIVES

MITSUBISHI 40MB	\$329	IMPRES 1.2GB	\$5199
CONNER 100MB	\$732	TEAC 1.2MB/1.44	\$82/78
RODIME 110MB	\$579	ITAMA 45MB IDE	\$287
RODIME 210MB	\$1099	ITAMA 90MB IDE	\$527
MAXTOR 200MB	\$1285	ITAMA 135MB IDE	\$659
MAXTOR 360MB	\$1999	ITAMA 180MB IDE	\$879
MAXTOR 660MB	\$2825		

MONITORS

MITSUBISHI DIAMOND	\$956	DATATRIN MONO	\$115
MITSUBISHI VGA	\$552	SUPER VGA-1024	\$469
TATUNG VGA	\$569	AOC VGA	\$399
DATATRIN VGA	\$522	NEC 3D	\$849
SAMSUNG VGA	\$495		

PRINTERS

ROLAND 2416-24pin	\$349	NEC 200 LASER	\$3499
ROLAND 2417-24pin	\$388	FUJITSU DCT100	\$389
ROLAND LP1110 LASER	\$1799	CANON LBP4 LASER	\$1279
HP LASERJET III	\$2250	HP TONER	\$114
HP LASERJET III	\$1350	HP LEGAL TRAY	\$49
HP DESKJET 500 PLUS	\$739		

ACCESSORIES

LOGITECH SERIAL MOUSE	\$79	WORDPERFECT 5.1	\$285
LOGITECH BUS or PS/2	\$89	LOTUS 123 v3.1	\$479
LOGITECH SCANMAN 256	\$419	PRACTICAL MODRM	\$189
ATI VGA CARD+MOUSE	\$239	WINDOWS w/mouse	\$166
MONOGRAPHIC CARD	\$29	SEAWAYS	\$39
101 KEYBOARD	\$65	PRINTSHOW PLUS	\$19

NORTHWEST INFORMATION SYSTEMS
683-6696
FAX 684-3255

LASER PRINTER SERVICE and DATA PROCESSING SUPPLIES

Full Service to Laser Printers

- Overnight service (where degree of problem allows)
- Competitive rates
- Guaranteed service

Call Today

**CLEANING
SPECIAL
\$39.95**

Includes FREE
inspection

PROTECT your investment
Avoid inconvenience & costly breakdowns
Keep your laser printer in clean, good working order
Helps extend life of both printer and toner drum/cartridge

**Total Recycling Program for Laser Carts & Printer Ribbons
Complete Range of OPC Drums, Developers, Toner Kits etc.**

VISTA LASER

Tel: 273-5446 Fax: 273-5478
11-12171 Bridgeport Road, Richmond B.C.

Coupon Worth \$10.00 Off

your first
recycled
cartridge

Ask about our complete recycling program
The Best in Quality and Service. Your Satisfaction is Our Reputation

The Everex Family



“ Just about anything you can plug
into a PC - and the PCs to boot ”
- PC Magazine



WKK SYSTEMS LIMITED

208-5701 Granville Street Vancouver, B.C. V6M 4J7
Phone: (604) 261-7899 Fax: (604) 261-8999



**INNOVATION
QUALITY
SERVICE**

EVENTS

Pacific Rim Computer & Communication Show Report

by The Computer Paper Staff



New CD-ROM Titles From Wayzata Technology

WASHINGTON, DC, JAN 15 (NB)—Wayzata Technology, a small Minnesota-based producer of Macintosh-compatible CD-ROMs, has announced the availability of "Down to Earth", a collection of more than 750 high-resolution color and monochrome (PICT format) desktop publishing images. "Clip Art Masterpieces Volume I" contains over 1300 turn-of-the-century engravings and woodcuts.

"Down to Earth", a \$249 CD-ROM disc, contains images related to conditions on earth, including waste dumps, flowers, food, landscapes, and marine images.

"Clip Art Masterpieces," with a list price of \$149, contains 300 dot-per-inch TIFF and PICT format images indexed in HyperCard.

For further information, contact Wayzata Technology, P.O. Box 87, Prior Lake, MN 55372. Phone 612-447-7321.

Sony Video Interface

SAN FRANCISCO, CALIFORNIA, JAN 15 (NB)—A "black box" that lets Macintosh computers control many consumer video products has been announced by Sony. The VBOX controller will give users complete remote control over most Sony products.

The VBOX (which is in fact white and is about the size of a paperback book) uses Sony's proprietary LANC remote control commands and its ViSCA machine control protocols. To date, only Sony video devices include a LANC port—specifically, all 8mm products and other products sold after the introduction of 8mm. While Sony plans to eventually publish the specifications to ViSCA, officials told Newsbytes there are no plans to build hardware that will bring the LANC and ViSCA protocols to equipment that doesn't have them already built in.

Among the Sony products that include LANC capabilities are 8mm camcorders, Video 8 tape decks, VHS and Beta VCR recorders, and laser disc players.

When Apple finishes writing drivers for the VBOX, Sony officials said, users will be able to control video equipment in much the same way they control printers and disk drives—in effect, printing to and retrieving data from video.

One of the breakthroughs incorporated in the VBOX is the price. When available early in the spring, it will have a retail price of \$250, Sony officials said.

Sony said Farallon and Macromind intend to incorporate ViSCA technology into their products in 1991. Other software publishers are also known to be interested. Contact: Technology Solutions, 212-505-9900.

Attendance was up slightly over last year, with 15,107 people attending the largest computer show west of The Great Lakes. The show was staged at the World Trade and Convention Centre in Vancouver. The Computer Paper once again had a booth, and from our vantage point on the floor, we got a glimpse of the I.D. badges of a large number of government and corporate visitors to the show as they, too, stopped by to pick up our latest issue. Here's our view of some of the highlights:

Just inside the front doors, the Sharp and Toshiba booths were spacious areas lining the "Grand Boulevard" of the centre aisle. A large crowd in the Sharp booth stood gaping at the 256 colors of its new PC-8501 VGA color 386 laptop. You could hear the oohs and ahs from across the room, as well as the occasional gasp when its \$18K price was mentioned.

Nearby, bucking the trend by many of its competitors, Zenith was back in the show in a big way, with an impressive and large booth that we, at least, felt worthy of an award. Featuring a full line of products, the display was staffed by Zenith and parent company Grupe Bull personnel from all over Canada and the western U.S.

Just down the aisle, at various times during the day, presentations occurred in a special "Showcase" area. Twice, we noted capacity crowds marvelling at the wonderful world of really-expensive-looking computer graphics as presented in videos and demonstrations by First Image. Ooh, ah!

Roland DG was showing an interesting hand-held signcutting machine, as well as its line of CAMM machines, plotters, printers and computers. Nearby, Mitsubishi was handing out photographic-quality prints from its new dye sublimation printer (at a reported cost-per-page of \$6), as well as demonstrating its monitors, scanners and lower-priced, but still impressive color thermal transfer printers. The Mitsubishi representative explained that the unit supported optional drivers for the PC and Mac, including Zenographics and PostScript.

Also showing high-end color output solutions at the show was Kodak, with its own XL7700 dye sublimation printer and ColorSqueeze software. A color output device of a different sort was found at the Brother booth, where a new \$9,500 color copier was cranking out impressive prints.

Just down the aisle, WordPerfect's booth was set up with a seating area and a podium where a representative gave hourly demonstrations. In the backdrop behind, several monitor screens displayed WP Corp's PC products, including a new WordPerfect for Windows. The WP booth was awarded the "Best of Show" award, although there were some that felt that Atari's impressive multi-storey display deserved the honor. A few people were (barely) heard to complain at the volume of the live & MIDI musical performances emanating from the Atari stage, although the shows by multi-tal-

ented mesomorph Tim Brecht really packed in the crowds. In particular, his hilarious full-blown rendition of "Let's do the Time Warp" was truly a marvelous example of the (mis)use of MIDI technology.

Another tremendously busy area was the NeXT booth, where reps were showing for the first time in Canada the new color NeXTstation. Shoulder-to-shoulder crowds watched a video of NeXT CEO Steve Jobs demonstrate—in his oh-so-convincing manner—how to write a database program in two minutes flat with his favorite computer.

Around the corner at Apple's booth, the crowd-grabber was an innocuous-looking machine in the corner with one of its windows displaying live full-motion video and sound—featuring Apple people explaining why Mac is *the* way to go with multimedia. Almost everyone who walked by did a double-take, and was drawn hypnotically into the booth. The same effect could be seen at the Commercial Electronics display with their live video-in-a-window, video editing and special-effects products for MS Windows and the Mac.

We were slightly amused to note the throngs around the Vend-U-Print machine, where for five bucks, you could print out a handful of instant business cards. Have you ever noticed that computer people just love high-tech machines all covered with buttons and instructions? Word has it that more than a few exhibitors depended on "Vend-U-Printed" cards for emergency card supplies. Regardless of what a professional typesetter might think, Vend-U-Print was quite a success.

At the Conti Computers booth: the PC Viewer 5000CX from In Focus Systems (distributed in Canada by SMART Technologies of Calgary, Alberta), a new 4,913-color LCD overhead projector display panel (for PC or Mac) that has better image definition than any others we've seen. Also at the Conti booth was a portable presentation device called the Liteshow II. The compact device contains a built-in special-effects generator with a variety of wipes, fades and dissolves and a disk drive capable of storing up to 30 PC-generated images per disk. PC and Mac images with up to 256 colors can be used. The LiteShow II plugs into virtually any monitor or video/data projection system and comes with a hand-held remote control.

Nearby, Sharp A/V was showing a most interesting interactive presentation device by Proxima called Cyclops that mounts on the top of its Versacolor II color LCD display panel. The name Cyclops isn't so strange when you find out that it is a camera pointed at a big projection screen that tracks the LED-equipped end of an arms-length pointer, translating the movements back into signals that control the position of the mouse pointer on the computer. Probably easier to use than it is to describe, it's kinda like the ultimate point 'n' click.

There were loads of other great things at the show, and aside from the solemnizing effect the announcement of war in the Gulf had near the end of the last day, a good time was had by all.

PowerSoft Gives Away 2000 Software Packages

Close to 2,000 attendees at this year's Pacific Rim show walked away with a working copy of PowerPay, a Canadian

payroll program from PowerSoft Systems of Vancouver.

There's only one catch—the program that was given away only works for four months, from the date the program is activated by the user.

"We put something in the code," explained company executive Ben Choi, and this allows the program to track the length of time it's been used, up to the four-month limit. At that point, users have to decide if they liked PowerPay enough to pay \$89 for a regular working

copy.

System requirements are 512K, DOS 2.0 or higher, a hard drive, and one floppy. It runs on IBM and 100% compatibles.

PowerSoft is offering free customer telephone support for purchasers of the package. Contact: 432-7077.

Shareware Booths Swamped

Among the busier booths was Kennen

Publishing of Los Angeles, Cal. The company was showing many of the 2000 shareware and public domain titles listed in its catalogue. At times, there were so many people crowded around this booth, it was impossible to get even a peek at the shareware on display.

Spokesman Bill Christie said he brought 1,000 catalogues from L.A. up to Vancouver, and they were gone long before the end of the show at 6 p.m.

CONTINUES ON PAGE 52

PostScript Power To The People!

The QMS-PS® 410 Printer. Developed by the greatest minds in the industry. . . Yours.



Before creating the QMS-PS 410, we performed one very important task. We listened. Then we took everything we heard, added a few surprises, and built a revolutionary laser printer with a suggested retail price of just **\$3995!**

You said make it Adobe® PostScript®. So we did. And now you can enjoy the design flexibility only PostScript offers as well as 45 resident typefaces and thousands of PostScript software applications.

You said make it reliable. So we used the Canon® LX print engine manufactured by the world leader in high-quality, easy-maintenance print engines.

You said make setup easy. So we made it truly and completely plug-and-play. Out of the box, it connects to IBM® PC and compatibles, Apple® Macintosh® and mini and mainframe computers.

You said make it flexible. So we added HP® LaserJet® Series II emulation to support non-PostScript printing applications.

You said make it simple. So we gave the QMS-PS 410 the intelligence to actually "think for you" by automatically switching between emulations and interfaces! This printer has ESP (Emulation Sensing Processor) technology,[†] which interprets incoming data and *automatically* chooses the appropriate printer language. And you can send data *simultaneously* to its AppleTalk®, serial and parallel interfaces! There's no need to change switch settings or send complicated software commands.

You said make it fast. So we created a super-fast controller with a 68020 processor and third generation QMS® ASAP™ (Advanced Systems Architecture for PostScript) technology, which incorporates the latest in component and controller design.

You said make it expandable. So we made a variety of options available, including an HP-GL® emulation card, Adobe typeface cards, HP-compatible font cards, memory upgrades and extended paper handling capabilities.



POSTSCRIPT®

Call Now and Let the QMS-PS 410 Liberate You - Just \$3995!

1-800-361-3392

You see, listening to you gave us the insight to develop a printer that offers real world solutions to real world problems. And the QMS-PS 410 delivers PostScript power to the people by giving you more solutions than any other printer on the market. Affordable. Reliable. Flexible. Solutions that set you free!



QMS Canada, Inc.

The following are trademarks or registered trademarks of their respective companies: QMS, the QMS logo, QMS-PS and ASAP of QMS, Incorporated. IBM of International Business Machine, Incorporated. Adobe, PostScript and the Adobe PostScript logo of Adobe Systems, Incorporated. Canon of Canon USA, Incorporated. Apple, AppleTalk and Macintosh of Apple Computer, Incorporated. HP, HP-GL and LaserJet of Hewlett-Packard Company.

*Canadian Suggested list price \$3995
†Patent Pending

Furniture & Workstations

Material imported from AUSTRIA "EGGER"
E-1 Chipboard overlaid with Anti-Acid,
Anti-Alkaline and Fire Retardant Melamine.

Its design conforms to human body structure.

Stylish comfort and Convenience

Easy to Assemble

Durable and Attractive



Dealer inquiries welcome

ComStar Distributors

Unit 368-13988 Cambie Rd., Richmond, B.C. Canada V6V 2K4 •
Phone (604) 279-0188 • Fax (604) 279-0288

The art of selecting the best computer system requires more than just inspiration and intuition.

As a leading manufacturer of micro-computers, Express Micro offers state-of-the-art components that are reliable and affordable.

We stand behind our products, secure in the knowledge that our international parent company has been providing integrated systems to the computer industry for almost a decade.

At Express Micro we are dedicated to delivering the complete package backed by service that's second to none.

Give us a call, we'll put you in the picture.

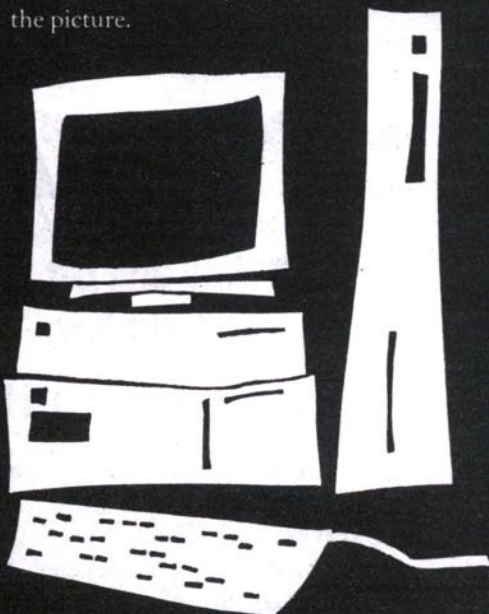

Express
Micro

13160 Vanier Place, Unit 160, Richmond, BC V6V 2J2
Tel 604 270-8561 Fax 604 270-4953

88 Konrad Crescent, Markham, Ontario L3R 8T7
Tel 416 479-5525 Fax 416 479-1834

EXPRESS SYSTEMS • VIEW PERFECT MONITORS • PANASONIC
DRIVES • MAXISWITCH KEYBOARDS • ASUS MOTHERBOARDS

ATARI

The Atari TT

Product: TT
Manufacturer: Atari Corp., 1150
Borregas Ave., Sunnyvale, CA
System configuration tested: 4MB
RAM, 50 MB hard disk, PCA 1426
color monitor
Price: TT030/2-50 \$2399.95 (prices
in U.S. dollars) TT030/4-50 \$2799.95
TT030/8-80 \$3499.95



by Graeme Bennett

First Impressions

When I unpacked the new flagship of the Atari line, the 68030-based TT and its color VGA-type PCA 1426 monitor, one of the first things that struck me was the design of the casing. It looks like an architect's model of a futuristic bungalow, or a computer designed by a bricklayer. Either way, it's a distinct change from the big clunky shapes that characterize most other brands.

Several elements of its compact design are downright clever, such as the way the monitor base interlocks with grooves along the sides of the top of the main unit to prevent the monitor's weight from straining its flat surface; or the way the detachable keyboard docks at the front of the main unit.

In a welcome change from earlier Atari models, the TT's keyboard has a crisp tactile response. Unfortunately, the power switch is in the middle at the very back of the machine, making it extremely inconvenient to reach. Most users will probably resort to powering up the system from a power bar instead.

Accompanying the TT were a couple of diskettes of utility software, a beginner-friendly, illustrated manual (printed in the slightly unusual-looking Helvetica variant that is typical of the Atari laser printer's GDOS output), and a quick-reference page. Of course I read none of them (manuals are for wimps!), and powered the machine up.

The 50MB hard drive began its warm-up cycle, and aside from the sound of its fairly noisy fan...nothing. Hmm. Humbled, I read the quick-reference page: "Press the space bar to boot from the hard drive." Very strange.

Back to the Feature

Once I had that key piece of information, the system sprang to life. The 50MB hard drive is pre-formatted to auto-boot and load a few memory-resident utilities, including a mouse accelerator, screen blanker and control panel. The extensible control panel (much like the one in Microsoft Windows or the Mac) allows the user to adjust various system parameters such as mouse acceleration speed, color preferences, and others.

The icon used to show the stereo sound balance is particularly unique: A face wearing headphones turns his head from side to side as the balance adjustments are made. Too cool.

New Desktop

Based on Digital Research's GEM Graphic Environment Manager, the new desktop has been dramatically enhanced over earlier incarnations of Atari ST series computers. It now goes far beyond

the PC version of GEM, sporting keyboard equivalents for nearly every drop-down menu function (for example, to select hard disk partition D: you merely tap Control-D). If, then, you decided you wanted that window to change to the directory of drive A:, you'd press Control-A. However, if you wanted to open an *additional* window for A:, you'd tap Alt-A instead.

All key equivalents are customizable, too. If you prefer to use "A" to perform the menu function labelled "Select All" instead of the default "E" (everything?), you can—easily. If you prefer your "New Folder" shortcut to be "N" instead of "F," no problem.

Also improved over earlier versions is the system's document and application launching abilities. By dragging any document over the icon of an executable program, you can force the program to try to launch that document.

If you want to display or print a text document, no need to launch a word processor—these functions are provided by the system software.

Users of other graphical user interfaces should take a look at just how fast the performance of the TT's desktop is. With the entire operating system in ROM, there are no slowdowns induced by hard disk limitations, and running at 32 MHz performance is very peppy, indeed. (Although no bugs have been reported so far, auto-loading RAM patches could easily be installed if necessary.)

In short, the TT's desktop is a great piece of work. If Atari spent some energy urging would-be Windows users to compare the TT's performance before they jump on the PC bandwagon, many people would probably realize just how rich in features and fast it is.

Hardware Heaven

In response to criticisms that earlier Atari models lacked industry-standard expansion and connectivity options, the TT includes several important hardware enhancements. Provided are four (!) serial ports, VGA-like color and megapixel TTL monochrome video, stereo sound, SCSI, a VME bus and an AppleTalk network port.

Like its Atari ST siblings, it includes an external floppy disk port, cartridge port, parallel printer port, ASCII hard disk connector, mouse, joystick and MIDI IN and OUT ports as standard equipment.

Compatibility

The TT's operating system seems very stable and provides a good measure of compatibility with software written for ST-series computers. Atari estimates that 80% of the existing ST software library is compatible with the TT.

In my own tests, it became evident that certain kinds of programs had more

troubles than others. All ST business programs (word processing/spreadsheet/database), desktop publishing, telecommunication and utility programs I tried seemed to function correctly. These ST programs fly when running at three to four times their "normal speed."

Less successful were ST programs that had color graphics, animation or copy protection. In addition, the two top MIDI sequencers—C-Lab Notator and Steinberg Cubase—both failed, although the popular and powerful Steinberg Pro 24 sequencer worked without a hitch, as did Passport's scoring program Encore.

I was pleased to find that Digidesign's high-end audio sample-editing program Sound Designer worked fine, too. Manipulating massive amounts of digital audio data requires just the kind of horsepower the TT can offer.

I successfully used a paint program called Sketch, the Script wordprocessor, Outline (a high-end vector graphics drawing program, approximately similar in capabilities to Corel Draw or Free-Hand), and numerous PD utilities. One of the best programs available for the Atari ST/TT is the desktop publishing powerhouse Calamus.

On the TT, its performance is astonishing. As an example, a full page of Calamus graphics and text prints from the TT to the Atari laser printer (at 300 dpi) in 10 seconds flat. Only users of DTP programs on any other computer can appreciate just how amazing that really is.

Also successfully tested were the Lotus 1-2-3-compatible spreadsheet LDW Power, and Precision Software's Superbase database. (The TT's internal 3.5-inch disk drive directly reads and writes standard IBM 720K diskettes, making data transfers to and from PCs a snap.)

Using STalker and STeno, possibly the best terminal and text editor combo available, it is reportedly even possible to run several different copies of STalker at once, to utilize the TT's four serial ports for multi-line telecommunications (if, of course, you would need to have several phone lines).

A few programs don't make full use of the TT's increased capabilities. For example, even though the TT has an on-board math co-processor, ISD's top-rated DynaCADD program does not currently utilize it, even though DynaCADD recognizes an optional math co-processor in earlier Mega ST models.

However, even without co-processor support, DynaCADD is an excellent CAD program, on par with IBM heavyweights like AutoCAD. (I was amazed to discover that DynaCADD can even output to the Roland CAMM-1 sign-cutting machine artwork from the above-mentioned Outline graphics program, making it a great "vertical market" solution for sign shops and design studios.)

WordPerfect, one of the "big names" in ST productivity software, had problems when I tested it, but I was informed by WordPerfect Corp. that an update released December 6, 1990 is TT-compatible. I was told by Ron Grant of GXR Systems that if you slow down the TT's key repeat speed, the minor problems with earlier versions of WP can be worked around.

Also, I found quite a few ST games that were unable to run—due, no doubt, to programmers "breaking the rules" to squeeze extra speed out of their code. Somehow, though, I doubt that this is

important to the person willing to shell out almost \$4300 for a Unix-capable workstation.

One product that has already been updated for compatibility with the TT is the popular Mac emulation cartridge Spectre GCR. Using version 3.0 of its software, I found that Mac programs were able to directly access the TT's 4MB of RAM as a 3840K Mac would, and I could read, write and format both DOS and Mac disks from Atari or Mac modes (a great feature!).

The TT/GCR combo flawlessly ran every Mac program I tried (according to a benchmark program called Speedometer, at speeds comparable to a Mac SE/30), including HyperCard, Aldus PageMaker, Quark XPress, Microsoft Word, Adobe Illustrator and Photoshop. According to Gadgets by Small, makers of the GCR, the TT high-res monochrome monitor's entire 1280x960 display can be used as the Mac desktop, as can the 640x400 monochrome mode of the color display.

Direct printing to dot matrix, inkjet, LaserJet or PostScript printers is supported, with appropriate drivers. LocalTalk network support for the TT's built-in AppleTalk port is not yet provided, but is slated for the next version of the Spectre software, as is full support for Mac SCSI devices.

Free Advice

A few of the sample programs provided on the disks that came with the TT are so weak, it's embarrassing. I suggest that Atari include a few killer sound or graphics demos (there are some dandies available!), demonstration versions of CAD or DTP applications—heck, *anything* would be an improvement over these trivial offerings. I'll wager that developers would even *pay* to have demos of their software installed on the TT's drive.

Better yet, Atari could take a nod from NeXT and bundle some real applications with the system. More than anything, Atari needs to give people solid reasons to buy this baby. Some may argue that that is the job of the salesperson, or VAR (value added reseller), but it is apparent that to get their "foot in the door" and even be considered, Atari has to offer a price/performance ratio that's not just as good, but *better* than the competition.

Apple, as usual, is an easy mark. Its 030-based Unix-capable machines are priced thousands higher than Atari's offering, but NeXT is breathing down everybody's necks in the \$5000 range, especially with their aggressive educational pricing. I feel that the TT's price is about \$1000 too high, but then again, the TT offers color and a larger software base than the NeXTstation does. Plus, the TT can easily be made IBM or Mac compatible, which is something that (as much as Steve Jobs might like to), his company cannot yet claim.

In Conclusion

If, as the saying goes, we are known by the company we keep, then the TT is destined to show up in networked labs in higher education and corporations; as a workstation in graphic design studios; in vertical markets like DTP, CAD and professional MIDI environments. As always, I recommend you ensure that it runs the software you want to use.

Easy to set up and use, the TT is a good example of hassle-free computing.



COMPU AGE®

1927 Burrard
Vancouver, B.C.
Tel.: 736-8408

3373A Kingsway
Vancouver, B.C.
Tel.: 435-7067

1857 Lonsdale
N. Van., B.C.
Tel.: 988-9823

**BUSINESS SOLUTIONS
FOR YOUR ORGANIZATION**

**SYSTEM INFORMATION
ALLOWS YOU TO CUT TIME AND LABOUR COST**

NETWORKING TO CENTRALIZE
ALL YOUR OFFICES INTO ONE

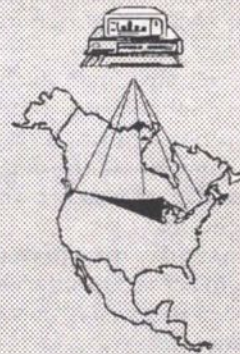

POINT OF SALES
CLIENT RECORDS
QUICK TILT ACCESS



INVENTORY
COMPLETE LIST
WHEN TO ORDER
WHAT TO ORDER
DAILY INVENTORY



ACCOUNTING
ACCT. RECEIVABLE
ACCT. PAYABLE
DAILY SALES
SIMPLIFY GST



TOTAL MANAGEMENT REPORT
SALES PERFORMANCE
PERIODIC REPORT

DESKTOP PUBLISHING

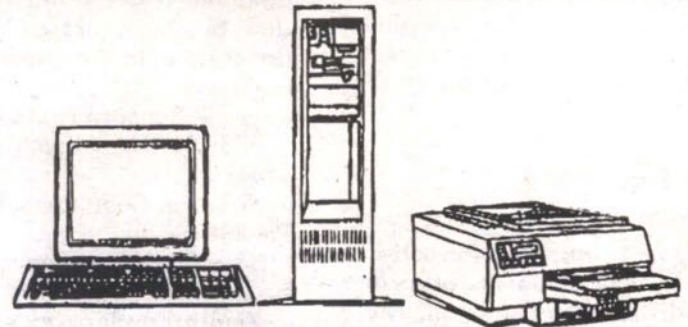

486/25

\$3495

386/33C

\$2195

386/25

\$1895

ALL SYSTEMS INCLUDE:

2MB RAM with Tower Case, 1.2MB Floppy Drive, 1 Serial, 1 Parallel, & 1 Game Port, 80MB Fast Hard Drive, Enhanced Keyboard

2 YEARS PARTS & LABOUR

Video

P/W VGA 14"
W/16 Bit Card
\$255.00

Super VGA 14"
W/16 Bit Card
\$495.00

P/W Full Page 15"
W/ Card
\$925.00

Printer

4 PPM Laser
17 Fonts
\$995.00

8 PPM Laser
Postscript Emulation
\$1445.00

Postscript 3MB (exp. 6MB)
35 Fonts
\$2745.00

Scanner

Hand Held
Best For:
Home/Small Office
\$250.00

8.5" x 14" Flatbed
16 IVI Grayscale
Best For: OCR
\$895.00

8.5" x 14" Flatbed
256 IVI Grayscale
Best For: True DTP
\$1375.00

CONTINUED FROM P. 49

Wednesday.
 Right next to Kennen's booth, and also busy, was Microtalent Distribution, another California company and fellow travellers with Kennen to Vancouver. Microtalent distributes Wizardware, a collection of shareware and public domain software that is grouped together by themes and called Wizpaks. They put together 10 disks of their best shareware and publicware software in a particular topic (e.g., children's education software) and sell the set of 10 disks, with five or six programs on each disk, at a suggested list price of US\$39.95. Microtalent also has a "hobbyist" CAD shareware offering that sells for the same price. Wizardware is sold in Vancouver by London Drugs and Future Shop.
 Did they like Vancouver? Microtalent's John Morley will be up for the Swap Meet at the McPherson Centre in Burnaby.

"Page Me in Toronto"

It's not uncommon these days to have a pager, or to see others with pagers clutched in hand. But did you know you can be off on business in, say, Toronto or Montreal, and still get paged by someone in Vancouver?
 A national paging service is provided by National Pagette, one of the exhibitors at this year's Pacific Rim Computer & Communications Show. There is one catch, though.
 "You have to pay extra for it," said Starr Ratcliffe, sales manager for National Pagette in Vancouver. Pagette, she said, is first to offer the national paging service, which is available for certain destinations across the country. Paging services are not yet available for subscribers travelling to the U.S. or abroad.
 National Pagette provides telephone answering and page message services and products through branches and dealers across Canada.

Quality Learning/Schoolware

Looking for a computer alternative to Nintendo for your school-age offspring? Look no further than Penticton, where Quality Learning Systems is offering its "Schoolware" educational software for

school-age students.
 "It's not intended to replace the teacher or parent, in any way, shape or form," said company president Kelly Kroeker. (OK, parents and teachers, breathe a collective sigh of relief!) "Schoolware is intended to supplement school courses; it's better if the parent works through the program with the student," he said.

Quality Learning was exhibiting its Schoolware product at the Pacific Rim Computer & Communications Show held Jan. 14-16 at the World Trade & Convention Centre in Vancouver. According to Kroeker, their product generated a lot of interest from attendees at the show, both from parents and potential dealers.

The new version of Quality's first package, Grades 5 & 6 English, should be ready to ship at the end of January, said Kroeker, with Grades 7 & 8 English ready by the end of March. These programs are undergoing final testing now.

Schoolware is presently aimed at the student who has access at home to an AT (DOS-based) computer, with VGA monitor. A Mac version may be available by mid-year, as well as high school versions.

Quality is developing, manufacturing and distributing Schoolware. Teachers, especially Manitoban Kevin G. Martin, have played a large role in the design of this package, and it has also been tested in Penticton schools.

Quality intends to distribute Schoolware right across Canada. Orders have already been received from various Ontario communities.

Suggested retail list price is \$89.95. Contact: 492-2592 (Penticton).

Great Giveaways

What's a computer show without promotional trinkets and bags to put all those brochures in? Here's an incomplete list of some of the goodies that caught our eyes:
 Javell: Popcorn (unbuttered)
 KIS: Hershey's Kisses. Is that cute, or what?
 Strachan Computers: Draw for Laser Pal 286 system
 The Computer Paper: Current and back issues, show guides
 Zenith: Envelope openers in the shape of miniaturized 3.5-inch disks

AFTER HOURS

BANNER MANIA

by Robert Tarrant

Most people who read this magazine take computers seriously.

After all, we are business people who look to the computer to get our work done. When we sneak in a computer game now and then we don't talk about it much. Well, here is a business application that is more fun than it should be.

Banner Mania is dedicated to one thing—producing banners, that's all. It does its job superbly.

You get one disk and a thin manual which you don't need. Install it on your hard drive or run it straight from the original floppy. You are escorted through a series of self-explanatory menus. A description or short instruction appears when a selection is made so you shouldn't need any online help, although it is available by pressing F1.

To start the program at the DOS prompt, type "Banner" and press Enter. Once the program is loaded, press Enter again to get past the "Banner Mania" opening demo screens.

At the Main Menu, you can start straight in to create your own banner or load ready-made banners to play around with. The best thing to do at this point, however, is to select Choose a Printer.

Banner Mania supports a wide variety of dot-matrix printers—the preferred way to create banners. It also supports a selection of laser printers, which are particularly suited for smaller banners or logos. Wide carriage and color are supported, too. Your printer is probably going to be on the list.

Select your printer and press Escape to get back to the Main Menu. It doesn't matter where you are, Escape will take you back to the previous menu.

To create your own banner, you choose Create New Banner from the Main Menu. You choose either a one- or two-line layout, then type in your banner message like.

Now comes the fun part. You are guided through a series of choices so you can make it look the way you want. First

you select one of the 19 available fonts on the Font Menu. You are then presented with 34 effects on the Effects Menu such as outline, shadow, block, perspective, balloons, etc. You can also specify a vertical banner from here.

Next comes the Color Set Menu. You choose a variety of foreground and background colors then move on to the Shape Menu where you can define the shape of your message.

There are 27 different shapes to choose from, among them wedge, concave or convex, wavy or even tear-drop shaped.

That is the end of the basic selection menus. You now arrive at the Print Menu, where you can go ahead and print out your banner. But wait—your banner may not be the right length or positioned on the paper the way you want, or perhaps you may want to change the color of the shading.

Not to worry. Here you can also fine-tune your previous selections. Select Change Colors, or Justification. You can alter the size of your letters and change the length, from 10% to 400%.

Is it time to print the banner? Not yet. It takes a while to print a long banner, so I suggest you preview the printout by pressing F2 from the selection of Function keys at the bottom of the screen.

The screen will start to scroll sideways, showing how your banner will look—complete with paper perforations and tractor-feed holes. When you have seen enough, Escape back to the Print Menu. If it looks good, you can save from this menu before you print.

So can you go ahead and print now? If this were an ordinary program, I would say yes, but it's not.

To really get an idea of the wide variety of ways your banner can look, select Transmogrify, then be prepared to delay printing up to several hours. This is the really fun part.

This has extensive business and human potential potential. For example, you could relax while your favorite affirmation transmogrifies before your eyes, or set up a color monitor in a store window to display your product message in over a billion ways.

Robert Tarrant is president of Office Evolution (767-6206).



UNIVERSAL TECHNOLOGY INC. (1986)



Logicom® 80386 DX
 • 25 MHz
 • 1MB Memory, 40MB Hard Drive IDE
 • 1.2 MB Floppy
 • S/P/G Ports
 • Hercules Compatible
 • 101 Enhanced Keyboard
 • Hi-Res Monitor
Sale \$1,798 \$1,598

Logicom® 80286 AT
 • 12 MHz
 • 1MB Memory, 40MB Hard Drive IDE
 • 1.2 MB Floppy
 • S/P/G Ports
 • Hercules Compatible
 • 101 Enhanced Keyboard
 • Hi-Res Monitor
Sale \$998 \$948

Logicom® 80386 SX
 • 16MHz
 • 1MB Memory, 40MB Hard Drive IDE
 • 1.2MB Floppy
 • S/P/G Ports
 • Hercules Compatible
 • 101 Enhanced Keyboard
 • Hi-Res Monitor
Sale \$1,378 \$1,278

LOWEST RATES IN RENTAL
 386-SX \$188/month
 AT \$148/month
 HP LaserJet IIP \$178/month
 Corporate Leases: Please call for FREE estimates

NOVELL NETWORKING
 Authorized Reseller
 Please call Kirby for a FREE estimate

Many computer stationary on sale at low, low prices. Paper, power bars, stands, ribbons, cables & books.
CALL FOR OUR DAILY LOW PRICES 255-9898.
 UPGRADE FROM AN XT system to a powerful 12MHz AT for only\$199 or to a 386SXfor only \$556
 1 Yr. parts & labour warranty.
 We specialize in IBM system technical service.
 POWER SUPPLY REPAIR\$48
 MONITOR REPAIR\$48
 SYSTEM DIAGNOSTIC COMPLETE\$14 (which will be exempted with work done)
 ON-SITE SERVICE\$35
 INSTALLATION PARTS\$35

386-33/64K Cache \$1038	14" VGA P/W Monitor \$188	Mitsubishi 40/60 MB \$348	AT MFM Controller 1:1 \$98	4-Bay Mini Tower Case \$138	Logitech Dexxa Mouse \$28.98	Diskettes 10/box \$5	with Logitech Mouse(s) \$178
386-25 \$698	14" Flat P/W Monitor \$148	TEAC 1.2 Floppy \$95	AT RLL Controller 1:1 \$118	150W CSA P/S \$85	Genius Mouse 6000+ \$55	Paper 500/pack \$5	Microsoft Works \$108
386-16 SX VLSI \$458	Raven 2417 \$398	TEAC 1.44 Floppy \$90	XT MFM Controller \$68	200 W CSA P/S \$98	101 Enhanced Keyboard \$78	Fax Paper 98 ft. Roll \$8	MS Quick Pascal \$68
386SX-16 NEAT \$498	Citizen GSX 140 \$368	TEAC 360 K \$85	XT RLL Controller \$68	200 W P/S 2 CSA P/S \$98	Keyboard w/ mouse & software \$138	2nd Serial kit \$18	MS Word for Windows \$328
286-12 \$128	Fujitsu DL1100 \$388	TEAC 720 K \$80	IDE Controller \$48	2400B Modem \$98	Chicony K/B \$59	IIP Toner \$118	MS Excel for Windows \$288
8088-12 \$88	HP LaserJet III \$1998	OAK VGA \$88	Serial Port \$28	Cardinal 2400B External \$148	Computer Desk 3 Levels \$108		
44256-8 \$8	HP LaserJet IIP \$1180	1024 X 768 VGA Card \$138	Parallel Port \$28	GVC 9600 (5 year warr.) \$798	Switch Boxes \$28		
DRAM, SIM, SIP \$80	Star NX 1000 \$248	ATI VGA Wonder 256K \$198	Game Port \$28	GVC Pocket Fax \$238	Power Bars \$13	DOS 4.01 \$78	
287-10 Math Coprocessor \$198	Star Rainbow Color \$328	ATI Graphic Solution \$88	4-Bay Slide Case \$68	GVC Pocket Modem \$128	Printer Stand \$9	WordPerfect 5.1 \$288	
	Conner 104 MB Kit \$798	AT I/O Card \$28	4 Bay Compact Case \$68		CPU Stand \$16	Lotus 123 \$498	
	Conner 40 MB Kit \$498	Everex XT Mem. Exp. \$118	4 Bay Compact Case with P/S LED \$138	Logitech Scanman Plus \$208	Copy Holders \$6	AccPac BPI \$289	
	Miniscribe 40 MB Kit \$348	Everex AT Mem. Exp. \$168	6-Bay Slide Case \$98	Logitech Mouse Serial \$88	Printer Ribbons \$9	AccPac Bedford \$148	
	20 MB Kit \$328		6-Bay Tower Case \$98	Logitech Mouse Bus \$98	Cables \$8	PC Anywhere III \$98	
NEC 3D Monitor \$868	Seagate ST251 Bare \$425	Hi-DEN Controller \$68	with P/S LED \$168	Logitech Trackman Bus \$119	Gender Changers \$9	PC Tools Deluxe \$128	
14" VGA Color Monitor w/card \$478	Kalok 30MB \$328	4-Port Controller \$98		Logitech Trackman Serial \$109		Desqview \$118	
12" TTL Monitor \$108						Microsoft Windows 3.0	

NEWSBYTES

NEC UltraLite

Product: UltraLite notebook computer

Manufacturer: NEC Corporation, 1255 Michael Drive, Wood Dale, Illinois 60191-1094

Configuration Reviewed: 640K RAM, 2MB silicon disk, 2400 bps modem, external floppy.

Price: C\$1395; 256K RAM cards C\$325 each. Additional batteries C\$140 each.



by Graeme Bennett

First Impressions

The first thing I noticed when I plugged in the UltraLite's AC Adapter/Charger was the inconvenience of having only a 1-foot cable between the transformer box (about the size of a pound of butter, but half as high) and the mini-DIN plug that attaches it to the computer. This forces you to put the AC adapter on the desk. If you use the thing on your lap while plugged into AC, good luck!

The UltraLite has no internal floppy drive or hard disk, instead using a 2 MB "silicon disk" ramdisk-type method of holding files loaded from the external floppy or another PC.

I lifted the flip-up cover over the external port, where the system's floppy drive plugs in. Oops. The tiny door fell off. OK, the door isn't broken, it clips back on. The floppy drive's cable is even shorter, a total length of six inches. Thank goodness it plugs into the side of the floppy drive and not the back.

The drive, bundled as part of the UltraLite package, has a capacity of 1.44 MB, but also reads 720K diskettes. I was more than a little surprised to find the system's only parallel port on the back of this unit. This means that you'll have to pack the drive with you if you want to print anything to a Centronics printer, unless you purchase an optional parallel adapter cable from NEC.

Look and Feel

The UltraLite itself, once disconnected from its charger and external drive, is a marvellously light unit that exactly fits my notion of a notebook computer. A winner of *PC Magazine's* Technical Excellence Award, the 8 x 11.5 x 1.375-inch unit is small enough to easily fit in a briefcase, or travel unobtrusively in a pile of papers. At 4.4 pounds (including battery), it is light enough to be picked up in one hand.

I liked the keyboard feel and layout, with function keys along the top and the cursor keys in the popular inverted "T" layout at the lower right corner. Lights are provided on the NUM LOCK and CAPS LOCK keys, and an extra ALT key can be found at the right of the spacebar.

The screen is CGA-standard, quite large, appearing as dark blue letters on a white background, with good contrast and only a hint of horizontal interference patterns, certainly as good as most other CGA laptop displays. When left unattended for a few minutes, the screen dims to conserve power. Contrast and viewing angle are adjustable.

Silicon Disks

When the UltraLite is turned on, after a brief test of its 640K of system RAM, it boots from its internal ROM drive "D:" which contains DOS 3.3 and the MS-DOS Manager application shell. A drive "C:" is also available which, unlike D:, can be written to. NEC refers to this pseudo-hard disk as a "silicon disk." Travelling Software's Lap-Link (Small) is included to facilitate the transfer of data from desktop PCs.

The UltraLite's incredibly small size is primarily due to its lack of an on-board floppy or hard drive. With only 2 megabytes of "silicon disk" storage, you are therefore limited to the amount of data you can load into it. Or are you?

On the side of the unit, a (difficult to remove) plastic panel reveals a card slot, for plugging in an additional credit card-sized slab of RAM or ROM. The proprietary RAM cards have a capacity of 256K. Popular programs on ROMs are also available, including Lotus 1-2-3 V. 2.0, Lotus Agenda, XYWrite, WordPerfect 5.0, MS Works 1.0, Metro Express and WordStar. According to Laurie Miller of Canada Portable Computers, prices vary, but cost about \$450-500 each.

On-board Modem

The UltraLite comes with a built-in 2400-baud Hayes-compatible modem, as well as an unusual 9-pin DIN external RS-232C serial port. A cable is supplied that adapts this port to the typical 25-pin serial port found on external modems, mice and serial printers. Also included in the UltraLite package are telephone wall-jack cords, with what appear to be large ferrite beads built into them, presumably to help reduce line noise.

Manuals

The UltraLite comes with several manuals, including a Quick Start Guide, Portable Guide, Application Software Guide and Comprehensive User's Manual. NEC offers free Technical Support if you have any problems, and a one-year warranty.

Conclusion

The battery ran out of power after about two hours, which is rather short compared with many other laptops, but then the UltraLite is considerably smaller than most, too, and hence has less bulky batteries. At its original price (in the \$4500 range), the UltraLite was a notebook for the classes. Now, at its dramatically reduced price it is one for the masses.

GEMINITM
Marketing, Incorporated

SEE YOU AT THE COMPUTER SWAP-MEET

MacPherson Centre Sat. Feb. 16th, 1991

Retail Location
555 Clarke Rd.
Coquitlam, BC V3J 3X4
(604) 936-6400

Hours: 10-6 Tues. - Thur., Sat.

12-5 Sun.

10-8 Friday

New Hours



Intelligent
Solutions

hp HEWLETT
PACKARD
Authorized Dealer

80286-12.....\$979
80386-20.....\$1499
80386-25.....\$1699
80386-33.....\$1999

All Systems Include:

-1MB RAM
-1.2MB or 1.44MB Teac Drive
-43MB Hard Drive 28ms
-12" Mono Monitor and Card
-101 Enhanced Keyboard
-AT I/O Card IP, IS, IG
-AT Size Case
-200W Power Supply CSA
Special Upgrade and Package
Prices Available!!

Hewlett **IR** Rand
80386-25 \$1999

Roland DG
ROLAND DG CORPORATION
DPC-2112 \$1319

Legend 1024x768 .28mm
c/w 1024x768 VGA Card.....\$569
Mitsubishi 65MB 28ms.....\$339
Western Digital 28ms.....\$299!
Maxtor 81MB 19ms 64K.....\$569
Infrared Cordless Mouse.....\$79
FUJITSU DL3400.....\$499!
HP IIP/III.....\$1365/\$2299
Roland DP800 Laser.....\$1489
Roland 9101 9 Pin.....\$249
Roland 2417 24 Pin.....\$449

-Desktop Publishing
-NETWORKS
-On Site Consulting and Training
-Mac/IBM Data Transfer
-Free Delivery
-Custom Configuration
-Free Phone Support
-One Year Manufactures Warranty on Parts and Labour
-Software, Cases, Boards, RAM, Controllers, and more!

Call 230-3436 or 230-7535 for additional products (Fax 683-5994)



PC COMPUTERS LTD.

#5-4200 NO. 3 ROAD, RICHMOND, B.C. CANADA V6X 2C2
TEL: (604) 276-8806 FAX (604) 276-0692
10235 KING GEORGE HWY, SURREY TEL: (604) 583-6575

HEWLETT PACKARD IIP \$1399.00 (CANADIAN WARRANTY)

The Novas 486 - 25MHz

1MB RAM, 40MB (28ms) Hard Drive, 1.2MB 5.25" or
1.44MB 3.5" Floppy, Parallel, Serial & Game Port,
Enhanced Tactile Datacomp Keyboard, 14" TTL B/W
Flat Screen Monitor, G.S.T./P.S.T. excl. **\$2995.00**

Same as above but:

NOVAS 386-33MHz 64K cache \$2,295⁰⁰
NOVAS 386-25MHz 64K cache \$2,095⁰⁰
NOVAS 386SX-25MHz non-cache \$1,695⁰⁰
NOVAS 386SX-20MHz: 16K cache \$1,425⁰⁰
LEO 386SX-20MHz: zero wait state \$1,345⁰⁰

Warranty: LEO: System-2 yrs. parts & 3 yrs. labour
NOVAS System 1 year parts & 2 yrs labour

OTHER UPGRADE OPTIONS AVAILABLE.

ALSO AVAILABLE:

FAXES: Canon, Raven

PHOTOCOPIERS

CELLULAR PHONES: Cantel Services

EXCEL 3.0**CONTINUED FROM P. 34**

profit ratio—without total advertising spending exceeding \$40,000. Solver would provide your answer.

Like Lotus 1-2-3/G, Solver uses nonlinear programming methods to handle a wider range of problems than the linear approach used in Borland's Quattro or CA's SuperCalc.

Hypertext Functions

Double-clicking on a SUM function shows how that figure was arrived at. You can even double-click on a formula con-

taining a reference to another worksheet, and Excel will open it and select the referent cell.

You can attach notes to cells that explain or comment on entries. Text boxes (with up to 256 unique fonts), graphical objects such as lines with arrowheads, circles, curves and rectangles can also be attached to worksheets.

A data consolidation feature (previously only available in Excel's OS/2 version) allows the summarization of information from a number of worksheets into one worksheet. For example, if three worksheets have sales data from different regions for the same time period, the

data can be quickly consolidated on a fourth worksheet — a departmental budget-balancer's dream.

Great Graphs

Like PageMaker and PowerPoint, Excel 3.0 supports Microsoft's Dynamic Data Exchange (DDE) protocol. This means that you can embed an Excel graph in, say, PowerPoint, where double-clicking on it will bring up Excel. And what graphs! Though not as extensive as those of Wingz, Excel's graphing capabilities are clearly superior to 1-2-3's.

Custom 16-color palettes can be created and graphics from other sources

can be imported. Charts can now be included directly on a worksheet, and pictures can be pasted into your 2-D charts, and used as series markers. For example, a picture of a gas pump could be pasted into a graph of gasoline sales and multiple copies of it stretched or stacked to represent the chart values.

3-D area, column, line and pie chart formats are also possible, and charts may be sized or moved anywhere on a worksheet, but the killer feature is this: To perform a graphical *what-if* analysis, simply select a data series, hold down the <Ctrl> key, and drag a data point around in the graph. Excel automatically changes the corresponding value in the worksheet. *What if, or what?*

Conclusion

Married as it is to the Windows environment, Excel tends to suffer, to some extent, from the same problems that all Windows apps do. Windows is a huge, modular operating system, constantly swapping data to and from disk, loading system resources from disk when RAM runs short. (Excel 3.0 supports virtual memory where available). Therefore Excel, like other Windows apps, wants RAM and disk space and lots of both.

Also, while technically not requiring a mouse, it becomes rather futile to try to keyboard one's way around Windows, so business users who prefer the lean, mean character-based 1-2-3 will probably not appreciate the mouse-induced benefits that Windows fans adore. Nevertheless, Excel 3.0 is a spreadsheet from a company that looks as though it has been listening to its customers. Excel goes far beyond simple number-crunching to offer significant new display and analysis powers to the spreadsheet metaphor.

CREATING THE NEW P2000+ WAS EASY. ALPS JUST USED SIMPLE ADDITION.

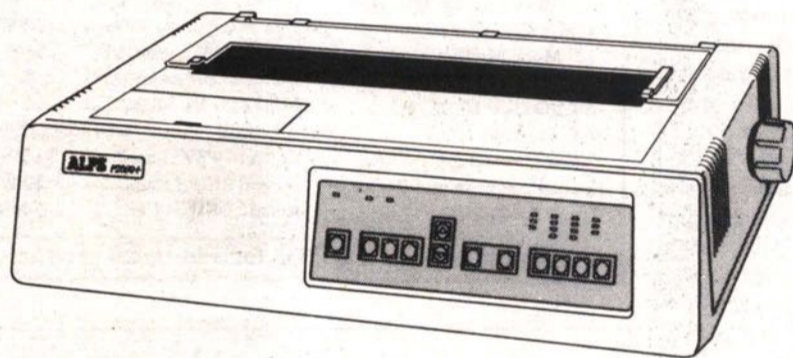

ALPS P2000+™ ALPS P2000+™ ALPS P2000+™

The original ALPS P2000 was already a great 9-pin wide carriage printer with a tradition of speed and rugged reliability. Now with the creation of their new P2000+, ALPS has taken a great printer and made it even better.

Here's how.

- For faster workflow, ALPS boosted the resident memory buffer from 4K to 64K. And you can add even more memory—up to 320K.
- Choose from three bidirectional print speeds: 55 cps letter-quality, 125 cps near-letter-quality and 250 cps draft.
- Thanks to ALPS' new Memory Mode, you can set power-on defaults from the front panel.
- Three resident fonts—Courier, Bar Code and OCR-A—give you more than 225 print variations. There are also two font slots for additional cartridges.

• The P2000's new Auto Tear Bar automatically resets your paper at the top of form position, eliminating paper waste. Manual tear bar is also available.

• The P2000+ now emulates Diablo 630 as well as Epson FX-100.

• Of course, ALPS left the best features of the original P2000 alone. Namely, its push/pull tractor system with bottom and rear paper feed, dual Parallel/Serial Interface standard, automatic single sheet loading and free ALPSmate printer control software.

To see the sum total of what ALPS' new P2000+ can add to your business, visit us today.

P2000+ is a trademark of ALPS Electric Co., Ltd. All other names indicated by ™ or ® are trademarks/registered trademarks of their respective holders. ©1990, ALPS America.

ALPS

AMERICA

Built by popular demand.

QUATTRO PRO 2.0 CONTINUED FROM P. 38

needed to calculate a desired outcome. An example of how you might use this would be to set it up to solve for the sales figure that you would need to achieve a desired profit amount. This function is easy to use and set up.

Documentation

Quattro Pro 2.0 has a good set of manuals, well laid out and with ample screen shots and a reasonable index to speed information access. There is a Getting-Started guide, a user's guide and a book on macros and functions. Borland also includes a handy quick-reference spiral-bound notebook, presumably designed to be left near your machine to remind you when you have forgotten how to do some rarely-used function.

Conclusion

This release is an evolutionary improvement on an already good spreadsheet. It offers good speed, flexible compatibility with the industry-standard Lotus format, more graph styles and graphics capabilities, and good presentation graphics skills. Borland's attractive upgrade offer for non-Quattro users should make this a popular spreadsheet.



NCP Vancouver
14 West 5th Avenue
Vancouver, BC
V5Y 1H5
(604) 872-7400
(800) 663-6153
(604) 872-4279 Fax

NCP Calgary
101,718 - 12 Avenue SW
Calgary, Alberta
T2R 0H7
(403) 263-3499
(403) 237-5317 Fax

NCP Edmonton
16636 - 117 Ave.
Edmonton, Alberta
T5M 3W2
(403) 454-7400
(800) 661-6959
(403) 455-5439 Fax

NCP Toronto
5,151 Carlingview Drive
Rexdale, Ontario
M9W 5E7
(416) 675-0125
(416) 675-2519 Fax

COMPUTER PAPER

COMPUTER CALENDAR

AMIGA

BURNABY SCHOOL BOARD:
Intro to Amiga 500: \$65

VAN SCHOOL BOARD: 736-7241
Amiga 2000 Lev. 1 & 2, Deluxe Paint 3, Computer Video Art, Computer Music \$85

ACCOUNTING

BCIT, 3700 Willingdon, Burnaby, 434-1610
Computerized Accounting \$196

BURNABY SCH. BD. 299-4361
ACCPAC Gen. Ledger, Bedford Acctng., \$90

COASTWAY 206-2501 Spruce, Van 736-5039
Bedford

COMPUTERLAND 1035 W. Pender 640-6900.
Bedford Accounting

COMPUTER STATION, 2130 Burrard St., 732-8621.
Bedford, ACCPAC G/L, A/R & A/P, \$180

ACCPAC • BEDFORD

Training and Start-up
From Former Online Support Staff at
BEDFORD SOFTWARE
Call Barb MacLeod at
CPET Publication Ltd.
574-5053
Benefit From
Our Knowledge & Experience

COQ. CONT EDUC. 936-4261.
ACCPAC G/L, A/R, A/P, Bedford \$80

DOPPLER 101 W. 5th 875-0261
Bedford/ACCPAC \$149

Our guarantee of the Best Computer Training

DOUBLE YOUR MONEY BACK!

Bedford

For \$149 we will Train You To Your Satisfaction or we'll give you a \$300 Refund. It's That Simple!
Lunch is served in our Air Conditioned Training Centre

Doppler
COMPUTER TRAINING 875-0261
101 West 5th Ave @ Manitoba St.

DOUGLAS COLLEGE, N. West 527-5472.
ACCPAC G/L Mar18-Apr8eve \$142
Bedford Basic Acct. Mar 9 \$102

DRAKE 601-889 W Pender 669-8789
ACCPAC/Bedford 1 day or Custom

GUILDFORD CONT. ED. CTR. 589-2221
Bedford (5 sessions) \$97

KWANTLEN CONT ED/TLD LABS, 599-2501
ACCPAC Intro, Mar 4-8 \$75
ACCPAC G/L, Acts Rec & Pay \$125
ACCPAC 3 in 1 Feb 18-22 \$200
Bedford Intro, Mar 4-8 \$200

LANGLEY CONT. ED., 533-4227.
ACCPAC Bedford

BEDFORD Accounting on Macintosh \$65

McKAY TECH. 2151 Burrard 736-7221
Computerized Bookkeeping 12 wks

NORTH SHORE CONT. ED.: 986-8888

NORMAN, RJ & ASSOC. 980-4137
ACCPAC Authorized Trainer (most modules)

ACCPAC AUTHORIZED TRAINER

Plus Series
BPI Series
Bedford, Easy
SuperCalc/Lotus 1 2 3

R J NORMAN & ASSOCIATES
980-4137

ROSSI, DeGROOT & ASSOC.: 683-0020
Bedford Acctg.

STRACHAN COMPUTERS LTD. #202-1760 Marine Drive, West Van, B.C., 926-6424
Bedford

SURREY (Newton Cont. Ed.) 594-2000
Bedford \$85

SYSTEMLINK, 600-890 W. Pender, 685-2528.
ACCPAC Plus & add-ons — custom training.

TXL MANAGEMENT 322-6198
NewViews Intro Seminar Free

VCC, 250 W. Pender St., Van., 682-5844
Bedford, ACCPAC, Acct. with Lotus 1-2-3 \$150

VCC CONT. ED. Certificate Prog. 324-5322
Intro to Bedford, ACCPAC \$160

VAN SCHOOL BOARD: 736-7241
ACCPAC Plus \$90
Bedford Acctg., NewViews Accounting, \$90

DATABASE

BCIT, 3700 Willingdon, Burnaby, 434-1610
DATA BASE CONCEPTS
BURNABY SCHOOL BD. 299-4361.
dBase III+ Level I \$80

CALEMA CONSULTING GROUP, 299-7795;
Advanced Revelation: Intro, User,
Programming & Advanced.

CAPILANO COLL. N Van 984-4901
dBase III+ \$100

COASTWAY 206-2501 Spruce, Van 736-5039
dBase IV, 12 hours \$400

COMPUTERLAND, 640-6900.
dBase IV Level 1 & 2 \$200

COMPUTER EMPIRE 879-4162
dBase III+ (call for dates) \$145

COMPUTER STATION 732-8621
dBase III (intro), on request \$180

CORPORATE PUB. GROUP, 687-1140.
dBase III+ dBase IV Level II, call for dates \$195

COQUITLAM CONT. ED. 936-4261
dBase (Intro, Inter.) \$90

DOPPLER 101 W 5, 875-0261
dBase Intro, dBase Adv.

Our guarantee of the Best Computer Training

DOUBLE YOUR MONEY BACK!

dBase Intro or Advanced

For \$149 we will Train You To Your Satisfaction or we'll give you a \$300 Refund. It's That Simple!
Lunch is served in our Air Conditioned Training Centre

Doppler
COMPUTER TRAINING 875-0261
101 West 5th Ave @ Manitoba St.

DOUGLAS COLLEGE New West 527-5472.
dBase IV Intro, Feb 23 \$102

DRAKE #601 889 West Pender 669-8789
dBase III+/IV, Smart, Symphony, Paradox

JUMP SYSTEMS Suite 450-650 W. 41st, 263-5867
dBASE III, RBase \$300

LANGLEY COLLEGE, 530-8411
Database 120 hrs \$85

LANGLEY CONT. ED. 533-4227.
dBase III+ \$175

MICROAGE, 3601 W. 16th Ave. 222-1010.
dBase III, IV, \$175

PBSC TRAIN, 900-885 W. Georgia 682-5615
dBase III+ L.1-2-3 \$200

PCTI 520-6873 dBase IV \$100
dBase III+ dBase IV, \$180/\$120

PROF. TRAIN., 502-1185 W Georgia 681-5903
dBase IV, L. 1, \$350; dBase III to IV, \$175

ROSSI, DEGROOT 1099-650 W. Georgia, 683-0020.
dBase III+ Intro & Adv., dBase IV \$175

STM SYSTEMS CORP. 684-7721
dBase III & Introduction \$175

UBC CONTINUING ED., UBC MicroLab, 222-5251
dBase IV: Intermediate, Feb.20-Mar.13 \$195

VANCOUVER SCHOOL BD., 736-7241.
dBase IV, Paradox 3.0, Intro., \$90

VCC CONT. ED. Certificate Prog. 324-5322
dBase IV, \$160

DT PUBLISHING

BUS. & PROF. RESEARCH INST., 1-800-445-3443
1 day seminar "Designing with DTP" Vanc. Feb. 8

BURNABY SCH. BD, 299-4361
Word Perfect 5.0, Level 1, \$90

CAPILANO COLL. N Van 984-4901
Desktop Publisher \$70

CIRRUS ENTERPRISES, Victoria, 386-8844.
PageMaker, Ventura \$85

COASTWAY, 206-2501 Spruce St. 736-5039
PageMaker, Ventura, Corel Draw \$190

COMPUTERLAND 640-6900.
(DOS) PageMaker, (MAC) Pagemaker, \$145

COMPUTER EMPIRE 879-4162.
Ventura \$145

COMPUTER STATION, 2130 Burrard St., 732-8621.
Ventura DTP, \$180

CORP. PUBL., 1500 - 701 W. Georgia St. 687-1140.
PageMaker 3.0, Ventura 2.0 \$390

COQUITLAM CONT. ED. 936-4261
Ventura or PageMaker \$90

DOUGLAS COLL. New West. 527-5470.
Ventura L.1, Fe20-Mar20 MW\$290

DOPPLER 101 W. 5th 875-0261
Ventura, Pagemaker \$85

GUILDFORD CONT. ED., 14577 - 106A Ave., Surrey, 589-2221. Mac PageMaker, \$85

JUMP SYSTEMS Suite 450-650 W. 41st, Vancouver 263-5867 PageMaker, Ventura \$190

KWANTLEN CONT ED/TLD LABS, 599-2501
PageMaker Intro, 5 eves, \$190

LANGLEY CONT. ED. 533-4227.
DTP With PageMaker, \$70; Mac Intro \$65

McKAY 2151 Burrard 736-7221

Desktop Publ, Graphic Arts 12 wks

MICROAGE 3609 W 16th 222-1010.
Aldus PageMaker Pt. 1, 2 \$175

NAVIGATOR TRAINING, 879-5427.
PageMaker, Freehand, Xpress, Illustrator,

NORTHWEST DATA, 985-9408

PBSC 900-885 W.Gorgia 682-5615
Harvard Graphics, Freelance Plus 1 day \$200
Corel DRAW 2 day \$400
PageMaker Intro & Adv; Ventura Intro & Adv.
3 day/\$650; 2 day/\$450

PCTI 520-6873 PageMaker \$100

PERFORMANCE SEMINAR GROUP, 1-800-445-3443
Designing & Preparing Camera-Ready Artwork
1 day Seminar Feb. 28 \$295

PITMAN 1490 W. Broadway 738-7848
PageMaker & Ventura (days/ eves.) \$180/120
Van. Desktop Publishing Prog. 12 wks.

PROF. TRAIN. 502-1185 W Georgia 681-5903
PageMaker, Ventura \$350

ROSSI, DEGROOT 1099-650 W. Georgia, 683-0020.
PageMaker, Ventura, Harvard Graphics

SELKIRK COLL., Castlegar 1-365-7292
Electronic Publishing, Graphic Design

SIMON FRASER Downtown 687-4255
Intro to Ventura Publisher \$160

STM SYSTEMS CORP. 684-7721
PageMaker \$320

STRACHAN COMPUTERS LTD. #202-1760 Marine Dr., West Van.926-6424, Intro, Adv., Private/group lessons
PC PageMaker, CorelDraw

VAN DTP CTR 1150 Homer 681-9161
Ventura, Pagemaker

VAN SCHOOL BD 736-7241
DTP IBM PageMaker 3.0, Ventura 2.0, \$135

VCC, 250 W. Pender St., Van., 682-5844
Graphic Design for DTP, \$75
PageMaker (Intro, Interim), \$160
DTP Workshop (PageMaker) \$375
Intro. to Ventura, \$160

VCC CONT. ED. Cert. Prog. 324-5322
PageMaker DTP, \$160
Fast Track PageMaker DTP, \$300
Intro to Ventura DTP, \$160

EVENTS

CANADIAN COMPUTER SHOW, Toronto, Oct. 21, 22, 23, 24

CANADIAN HIGH-TECHNOLOGY SHOW, Montreal, Apr. 30, May 1; Toronto, Oct. 22, 23

SOFTWARE WAREHOUSE

IBM COMPATIBLE SHAREWARE & PUBLIC DOMAIN SOFTWARE

UTILITIES

UM280 XTREE v. 2.00e World's most used HP

UD157-9 PC-FILE 5.0 - Best

UM273 STACK

UA111 4DOS v.

UH55 AnaDisk &

GAMES

EG333 CAPTAIN

CATALOG ON DISK \$2 (refundable on next order) FREE UTILITIES DISK on purchase of 5+ disks. We accept VISA, MASTERCHARGE.

5.25" Disks \$2.95 * VISA * P.O. Box 223, Port McNeill, B.C. V0N 2R0

3.5" Disks \$3.50 Phone: (604) 956-4757 ALL DISKS FULL * 9000 TITLES

SECTOR TECHNOLOGIES LTD.

Computer Hardware Specialist

Grand Opening Special

Tel: 876-9943

Fax: 876-9980

386SX-16MHz \$1349

286-12MHz \$950

386SX-20MHz \$1489

386-25MHz \$1699

386-25MHz \$1939

64K Cache

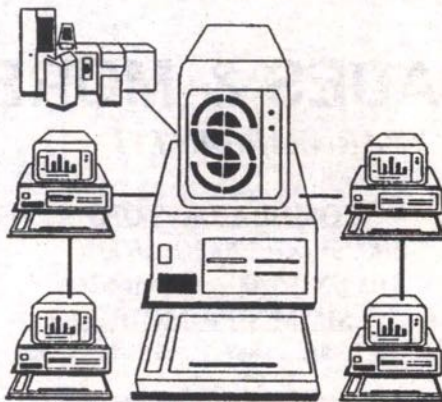

All systems include:

- 1MB of RAM
- IP, 1S, 1G Port
- Mono Graphics Card
- Keyboard
- 14" Amber Monitor
- HDD/FDD IDE Ctrl.
- 1-1.2MB Floppy Drive
- 40MB 28ms IDE HD

SUPPORT SERVICES:

In-house and on-site service contracts at reasonable rates are available on variety of systems.

Extended warranty available - Call for details

QUALITY SERVICE IS OUR GOAL

System training, microcomputer upgrades, printers and other accessories are available

TWO YEARS LABOUR AND PARTS WARRANTY

3COM, Novel, Unisys

621 Kingsway, Vancouver

PC'S, NETWORKS AND UNIX SYSTEMS



Quartech Suite 202 Telephone
Systems Ltd 1909 W Broadway 604-734 3117
 Developers and Vancouver BC Facsimile
 Consultants V6J 1Z3 604-734 8380

Quartech Systems, a computer systems development and management consulting company in Vancouver, is looking for seasoned software development professionals to work with our clients. Both short and long-term contract and employee positions are available.

We require experience in:

PL/1 • COBOL • DB2 • IMS

Openings are also available in our:

Micro Support Division

Qualified individuals should send their resumes to the attention of the Administrator.

When there's only time to do it right...

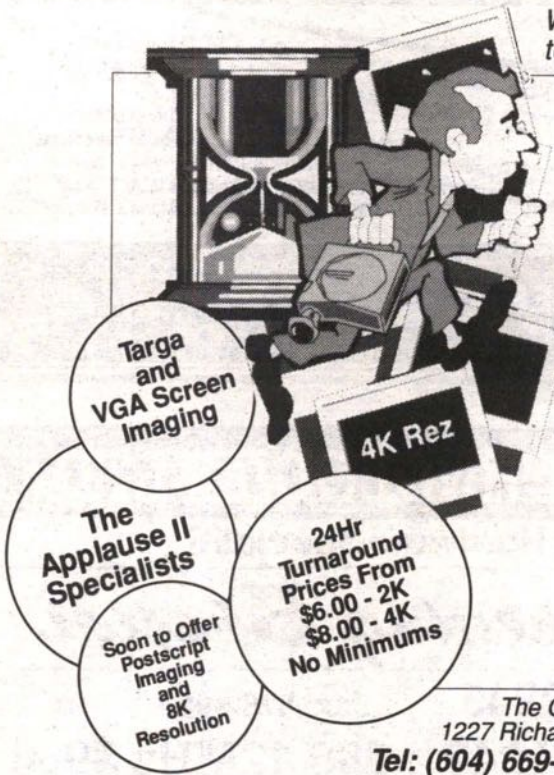

Computer Generated:

- Slides
- Overheads
- Print Illustration
- Design

Full Production Facilities, Complete Imaging Services, 24hr Modem & Fax In House E-6 Slide Processing Full Optical Effects Department

Imaging for Software Files From:

- Harvard Graphics
- Freelance Plus
- PC-Slide
- Draw Applause
- Corel Draw
- Mirage
- Pixie
- Super Image
- 35mm Express
- Pansophic Studioworks
- Lotus
- Autocad
- Excel

...and much more including a wide variety of Macintosh software

The Graphic Resource Group Limited
 1227 Richards Street, Vancouver, V6B 3G3
 Tel: (604) 669-2287 Fax: (604) 669-9137

MEMORY UPGRADES & MORE
 LOWEST PRICES! - 5 YEAR WARRANTY!

HP LASER JET MEMORY

1MB/2MB Upgrade \$149/\$215
 3MB/4MB Upgrade \$279/\$345

D-RAM

44256-80.....\$7.55 1MB-80.....\$7.45

TOSHIBA LAPTOPS

1000SE/XE,1200XE,1600,
 3100SX,T5200 From \$265

SIMM/SIPP MODULES

1*9-80.....\$69 1*8-80.....\$66

GOLD STAR 386SX BATTERY-OPERATED LAPTOP

1MB RAM (exp. to 5MB), VGA display, 40MB (25ms) Hard Drive, 1.44MB Floppy, 1 Serial & 1 Parallel port or external 5.25 FDD drive port, Internal removable & rechargeable battery pack, MS DOS 4.01 with DOS Shell, Weight 5.8kg including battery pack.....\$2645

MACINTOSH HARD DRIVES

Quantum SCSI 105MB External.....\$795
 Maxtor SCSI 96MB (26ms) External..\$745
 Seagate SCSI 40MB (28ms) External..\$495

IBM HARD DRIVES

Micropolis ESDI 115MB (16ms).....\$595
 Microscience RLL 120MB (28ms).....\$539
 Misubishi RLL 64MB (26ms).....\$345

COMTECH DISTRIBUTORS INC.

#5-1610 Langan Ave., Port Coquitlam, BC V3C 1K6
 Tel: (604) 942-5549 or (604) 657-2445 Fax: (604) 942-1780
 HOURS: Monday-Wednesday 10-5 Thursday-Friday 10-8 Saturday 10-4

COMPUTER PAPER COMPUTER CALENDAR

Our guarantee of the Best Computer Training
DOUBLE YOUR MONEY BACK!

Ventura Complete 2 Day Course

For \$275 we will Train You To Your Satisfaction or we'll give you a \$500 Refund. It's That Simple!
 Lunch is served in our Air Conditioned Training Centre

Doppler COMPUTER TRAINING 875-0261
 101 West 5th Ave @ Manitoba St.

Our guarantee of the Best Computer Training
DOUBLE YOUR MONEY BACK!

PageMaker Complete 2 Day Course

For \$275 we will Train You To Your Satisfaction or we'll give you a \$500 Refund. It's That Simple!
 Lunch is served in our Air Conditioned Training Centre

Doppler COMPUTER TRAINING 875-0261
 101 West 5th Ave @ Manitoba St.

- CBTA, Edmonton, Sept. 18,19,20
- COMPUSALE, Industrial Trade & Consumer Shows Inc.(416)252-7791 Toll-free 1-800-268-0387 or fax (416) 252-9848. March 8, 9 & 10, 1991, Automotive Building, Exhibition Place, Toronto.
- ELECTRO, New York, Apr. 16, 17, 18
- HOME BASED BUSINESS SEMINARS by H.A. (Buzz) Bezanson. HOME MADE MONEY (How To Successfully Start a Home Based Business). North Vancouver 986-8888.
- EDUCATING THE NEXT GENERATION OF PUBLISHERS: AN INTERNATIONAL CONFERENCE, Cdn. Centre for Studies in Publishing, SFU at Harbour Centre, 515 W. Hastings St. May 3-4, 1991. Brings together leaders in publishing industry and professionals engaged in teaching of publishing. 291-5096.
- FALL COMDEX, Las Vegas, Oct. 21,22,23,24,25
- GIS '91: Geographical Information Systems Symposium & Trade Show, Van Trade & Convention Centre, Feb. 12-15, Tel. 688-0188 for registration and information.
- INFO, New York, Oct. 1,2,3
- INTERFACE, Atlanta, Mar. 26,27,28
- LOCAL AREA NETWORKS, Feb 5-6 Hotel Meridien, 845 Burrard St., Vancouver, 2day \$895, Data-Tech Institute, Call 1-201-478-5400
- MONTREAL COMPUTER SHOW (SIIM '91), Montreal, June 5,6,7
- NETCON, Sept. 26,27
- PACIFICA FORUM 1991: Innovation in Publishing, May 29-30, 1991. The Cdn. Centre for Studies in Publishing, SFU at Harbour Centre, 515 W. Hastings St. 291-5073.
- Two-day event showcasing innovative ideas and experiences in all facets of publishing industry.
- PC EXPO, June 25,26,27
- PUBLIC LEGAL EDUCATION SOCIETY. Free class on computers and the law for sellers, buyers and users. 438-4041.
- QUEBEC BUSINESS COMPUTER SHOW, Quebec City, Apr. 3,4,5
- SPRING COMDEX, Atlanta, May 20,21,22,23
- 3X MIDRANGE, Atlanta, Mar. 26,27,28
- 3X, Toronto, Sept. 5,6
- UNIX SHOW, Toronto, May 15,16,17
- VARDEX/Montreal, Apr. 17,18
- VARDEX, Toronto, June 12,13
- WESCON, San Francisco, Nov. 19,20,21

NETWORKS

- BCIT, 3700 Willingdon, Burnaby, 434-1610
 COMP 286, Novell Netware 286, \$100
- CENTRE FOR ADVANCED PROFESSIONAL ED. (800)345-0240
 Troubleshooting LANS
- CIRRUS ENTERPRISES, Victoria, 386-8844.
 Intro. to Local Area Networks
- COMPUTER EMPIRE 879-4162.
 Networking Sys. Instal. \$245
- DATA-TECH INSTITUTE, 1-201-478-5400
 Local Area Networks, 2 day seminar, Feb.5-6 \$895
- DRAKE #601 889 West Pender 669-8789
 Netware System Manager for Novell
- JUMP SYSTEMS Suite 450-650 W. 41st, 263-5867
 3Com Network Admin., Novell Netware
- KWANTLEN CONT ED/TLD LABS, 599-2501
 Intro Networking, call for dates & \$
- MICROAGE, 3601 W. 16th Ave., 222-1010.
 Novell Syst. Mgr. \$695
- NETWORK SPECIALISTS INC., Burnaby, 294-5855
- Various network & Novell courses
- ROSSI, DEGROOT & ASSOC. 1099-650 W. Georgia, 683-0020.
 Novell Network Operations.
- SOFTRAK SYSTEMS, 1661 W.8th, 736-3741

- Novell. Call for info.
- UBC CONTINUING EDUC., 222-5251
 Local Area Networks, Feb. 16, \$85
- VCC CONT. ED. Certificate Prog. 324-5322
 LAN Network Management (1) \$190

MACINTOSH

- ADVANTAGE 535 Howe St., 685-6227 \$180
 Macintosh Level I, Feb. 4&18
 Macintosh Level II, Feb.4,11&18
 Macintosh Level III, Feb.11
 MS Word Level 1, Feb. 5,12 &19
 MS-Excel Level 1, Feb. 19
 Microsoft Word Level II, Feb. 6&20
 Microsoft Word Level III, Feb.21
 Aldus Pagemaker, Feb. 14&27
 MacDraw Lev. I, Feb. 13
 Persuasion Lev. I, Feb. 13
 Filemaker Pro, Feb. 21
 Macintosh Networking, Feb. 28
- BCIT, 3700 Willingdon, Burnaby, 434-1610
 COMP 190, Meet the Mac, 12 wks \$200
- BURNABY SCHOOL BOARD,
 DeskTop Publishing, \$85
 Microsoft Word on the Mac, \$90
- CAPILANO COLL. N. Van 984-4901
 Basics of Micro-Computers \$185
- DRAKE, #601 889 West Pender 669-8789
 Word Intro, Excel Intro
- ESI, 410-3771 Jacombs Rd., Richmond, BC, 276-2811
 Accelerated Learning Courses: Intro to Macintosh;
 MS Word, Aldus PageMaker
- FOLKSTONE DESIGN, 886-4502
 MicroSoft Word, PageMaker, Excel
- GUILDFORD CONT. ED. Surrey, 589-2221.
 Intro. to Mac., (5 sessions) \$65
 MSWorks (5 sessions) \$65
- LANGLEY CONT. ED. #88, 533-4227
 Macintosh Intro \$65
 Macintosh Painting & Drawing \$65
 Microsoft Works/Macintosh \$65
- MACSUPPORT 737-6985
 On-site instruction, consultation, development. Mac
 intro, Word, Excel, Works, MacDraw, SuperPaint, Page-
 Maker, HyperCard, FileMaker, Foxbase, 4th Dimension.
 McKAY TECH INSTITUTE: 2151 Burrard St.,736-7221
 Intro Macintosh \$85; MS Works \$150
 Word \$85, PageMaker \$200
 File Mgmt \$85,Freehand 2.0 \$150
 Quark XPress 3.0 \$450
- SFU DOWNTOWN, 291-5100
 Intro. to PageMaker \$175
- SURREY (Newton Cont. Ed.) 594-2000
 Intro to Mac \$85
- UBC CONTINUING ED., UBC Microcomputer Lab, 222-5251
 Using MS-Works in a Mac Environment, 2 Sats &
 Suns, \$195
- VAN SCHOOL BD 736-7241.
 Mac Intro, PageMaker, Excel, Word, MS-
 Works, Bedford, WordPerfect, SuperPaint \$89

MUSIC/MIDI

- ANNEX HIGH TECH MUSICAL INSTRUMENTS, 1250
 Granville St., Van 682-6639.
 MIDI Music Tech, 6 eves. \$150
 Peavey DPM 3 Digital Work Station,
 Performer MIDI seq., C-Lab Notator \$35
 E-MU Proteus Voice Creation, \$35
 Yamaha SY77 Digital Workstation \$35
- CARILLON MUSIC LTD., #160-8171 Ackroyd Rd., Rich-
 mond, B.C. 276-2383
 Instruction on many popular Music programs including
 Cakewalk,
 MusicPrinter Plus, Personal Composer Version, The
 Final Cut,
 Band-in-a-Box. Four (4) hours for \$99.

PROGRAMMING

- BCIT, 3700 Willingdon, Burnaby, 434-1610
 Computers in business, various programming
 languages. Call for information.
- BURNABY SCHOOL BD, 299-4361.
 BASIC I \$48
 BASIC II \$65
- CARIBOO COLL., Kamloops, 828-1916
 Intro Micros \$105
- CIRRUS ENTERPRISES, Victoria, 386-8844.
 Course Devel. services, Intro to SAS
- LANGLEY CONT. ED. #88, 533-4227
 How to Get Started with Your Computer
 Managing Your Hard Disk \$85
 Earn Money with Your Computer \$50
- LEARNING TREE INT., 1-800-267-1824
 Project Management, Halifax, N.S., July 24-27.
- SIMON FRASER UNIVERSITY, Burnaby V5A 1S6; fax
 291-4951.
 Digital Cellular and Personal Telecommunications
 Getting a Grip on Knowledge Processing
 Simulation, \$50
 Introduction to Neural Networks, \$250
 Design & Fabrication of Analog Integrated
 Circuits Using the QuickChip Prototyping
 Facility, \$600
- VCC CONT. ED. Certificate Prog. 324-5322
 Intro. to Modula 2 as a 2nd Language
 Fundamental Concepts of Computing
 Intro. to Formal Topics in Computing Science
 Software Engineering
 Intro. to Digital Circuit Design
 Operating Systems 1
 Info Systems Management

COMPUTER CALENDAR

System Development Projects
Database Systems and Structures
Info. System Design
Digital Circuits and Systems
Microcomputer Hardware Workshop

SPREADSHEETS

ACCSYS Suite 203, 535 Thurlow St. 685-5342	
Lotus	\$150
BCTEL GROUP, Education Development Centre, 1 day, 293-3636	
Lotus I Feb 2	\$200
Lotus II Feb 9	\$200
Lotus III Feb 16	\$200
BCIT F/T 432-8419, P/T 434-1610	
BCIT, 3700 Willingdon, Burnaby, 434-1610	
Framework II, Lotus 1-2-3	
Comp 115, Spreadsheet Concepts,	\$70
Comp 169, Lotus 1-2-3 - Level 1,	\$196
BURNABY COLLEGE, 437-5711 Lotus	
BURNABY SCHOOL BD, 299-4361.	
Lotus 1-2-3, \$85	
CARIBOO COLL., Kamloops 828-1916.	
Spreadsheets	\$150
CIRRUS ENTERPRISES, Victoria, 386-8844.	
Lotus 1-2-3, QuattroPro Intro., Excel	
COASTWAY 2501 Spruce, Van 736-5039	
VP Planner Plus 12 hrs, Lotus 1-2-3 12 hrs	
COMPUCOLLEGE Van 682-6600 Bby 435-2424, Rich	
273-0373. Micro Business Appl.	
COMPUTER EMPIRE 879-4162.	
Lotus 1-2-3 (call for dates)	\$145
COMPUTER STN 2130 Burrard 732-8621	
Intro to Lotus 1-2-3,	\$180
Intermed. Lotus 1-2-3,	\$180
CORPORATE PUB. GROUP, 1500-701 W. Georgia,	
687-1140	
Lotus 1-2-3 Level II	\$195
Advanced Lotus	\$195
COQUITLAM. CONT. ED. 936-4261	
Lotus 1-2-3 Lev. I & II	\$90
DOPPLER 101 W. 5th 875-0261	
Lotus 1-2-3 Intro & Adv.	\$149

Lotus 1-2-3 Release 3, \$90	
VAN. COMM. COLL., 250 W. Pender, 682-5844	
Acct. with Lotus 1-2-3	\$150
Intro to MS Works 2.	\$150
Using Lotus 1-2-3	\$190
VCC CONT. ED. Certificate Prog. 324-5322	
Intro to Lotus 1-2-3,	\$160
Intermed. Lotus 1-2-3,	\$160

TELECOM

UBC CTR FOR CONT. ED. 222-5251	
Concepts in Data Comm., Feb 9 \$75	

USING YOUR PC

ACCSYS Suite 203, 535 Thurlow 685-5342	
DOS	\$150
BC TEL GROUP, Education Devel. Ctr., 293-3636	
PC: Intermed. DOS, 2 day Feb 9, \$200/day	
BCIT Full Time 432-8419, Part Time 434-1610	
Understanding MS DOS	
BCIT, 3700 Willingdon, Burnaby, 434-1610	
Computing for the Timid	\$70
Understanding PC/MS-DOS	\$100
BURNABY SCHOOL BD, 299-4361.	
MS DOS/IBM Intro,	\$90
CAPILANO COLL. N. Van 984-4901	
Basics of Micros, DOS 1 & 2	\$185
Managing Your Hard Disk	\$105
CARIBOO COLL. Kamloops, 828-1916.	
Intro. to Microcomputers	\$105
CENTRE FOR ADVANCED PROFESSIONAL ED. (800)	
345-0240	
Converting, Expanding IBM PC	
Maintaining, Troubleshooting	
COASTWAY SYSTEM TECHNOLOGY	
206-2501 Spruce St., Vancouver 736-5039	
Hard Disk Management	\$120
COMPUTERLAND 640-6900.	
PC Literacy	
COMPUTERPEOPLE	
110-1178 W. Pender 682-5421	
Intro Microcomp, MS-DOS	
COMPUTER STN 2130 Burrard 732-8621	
Intro to MS-DOS,	\$180
COMPUTER TRAINING CENTRE, 103-20256 56th Ave.	
Langley, 534-5777.	
Intro to MS-DOS	\$80
COQUITLAM. CONT. ED., 936-4261	
Intro to IBM PC	
DELOITTE & TOUCHE, 1700-666 Burrard 669-3343	
Business use of microcomputers:	
Hands-on seminars. Per day:	\$225-250.
DOPPLER 101 W. 5th, 875-0261	
Intro: Micros & DOS	\$149

Our guarantee of the Best Computer Training
DOUBLE YOUR MONEY BACK!

LOTUS 123 Intro or Advanced
For \$149 we will Train You To Your Satisfaction or we'll give you a \$300 Refund. It's That Simple!
Lunch is served in our Air Conditioned Training Centre

Doppler COMPUTER TRAINING
875-0261
101 West 5th Ave @ Manitoba St.

DOUGLAS COLLEGE, N. West 527-5472.	
Lotus 1-2-3 L.1 Feb 16	\$102
	L.2 Mar 2
\$102	
DRAKE #601 889 West Pender 669-8789	
Symphony, Smart, Lotus	
IPC SYSTEMS, 228 W. 7th 873-5595	
Lotus 1-2-3 Basics Call for dates	\$150
JUMP SYSTEMS Suite 450-650 W. 41st, Vancouver	
263-5867	
Lotus 1-2-3, Excel	\$120
KITSILANO NEIGHBOURHOOD HOUSE, 2325 W. 7th,	
736-3588	
Lotus 1-2-3, Intro	\$120
KWANTLEN CONT ED/TLD LABS, 599-2501	
Lotus 1-2-3 L.1, Mar 25-28	\$130
Excel, Feb 18-22, 5 aft.	\$200
LANGLEY COLLEGE, Langley 530-8411	
Spreadsheets 120 hrs	\$300
LANGLEY CONT. ED. 533-4227.	
Lotus 1-2-3 L.II, Wed., 8 p.m.	\$85
McKAY TECHNICAL INSTITUTE, 2151 Burrard, 736-7221	
Lotus 1-2-3, 20 hrs.	\$250
MICROAGE 3601 W 16th 222-1010.	
Lotus 1-2-3, Pt. 1	\$175
NORMAN, RJ & ASSOC. 980-4137	
ACCPAC Authorized Trainer	
SuperCalc/Lotus 1-2-3	\$200
PBSC 900-885 W. Georgia 682-56151	
Lotus 1-2-3, Excel	\$200
PCTI 520-6873, Lotus 1-2-3	\$100
PITMAN 1490 W. Broadway 738-7848	
Lotus 1-2-3 days/eves.	\$180/120
PROF. TRAIN., 1185 W Georgia 681-5903.	
Lotus 1-2-3 \$175, Excel Basics	\$350
ROSSI, DEGROOT & ASSOC. 1099-650 W. Georgia,	
683-0020.	
Lotus 1-2-3, Levels 1 & II	
Macro Programming	
SOUTH GRANVILLE 1652 W 7th 732-8850.	
Call for dates Lotus 1-2-3, 2 wks	\$375
STM SYSTEMS CORP 684-7721	
Lotus 1-2-3 Intro	\$175
STRACHAN COMPUTERS LTD. #202-1760 Marine	
Drive, West Van., 926-6424 private or group lessons	
Lotus 1-2-3 & VP Planner, Intro, Adv.	
SURREY (Newton Cont. Ed.) 594-2000	
Lotus 1-2-3	\$85
UBC CENTRE FOR CONT. ED., 222-5251	
Lotus 1-2-3 Inter.	\$195
Intro Spreadsheets, Quattro,	\$195
VANCOUVER SCHOOL BD., 736-7241	

Our guarantee of the Best Computer Training
DOUBLE YOUR MONEY BACK!

DOS Complete Introduction to PC Computers
For \$149 we will Train You To Your Satisfaction or we'll give you a \$300 Refund. It's That Simple!
Lunch is served in our Air Conditioned Training Centre

Doppler COMPUTER TRAINING
875-0261
101 West 5th Ave @ Manitoba St.

DOUGLAS COLLEGE, N. West, 527-5472.	
Know Yr Computer, Feb6-20	\$115
Hard disk Mgmt., Feb. 9	\$102
MS/PC DOS Intro, Feb 2	\$102
	eves, Fe27-Mar13
\$115	
DRAKE #601 889 West Pender 669-8789	
DOS: Intro; Advanced	
FRASER VALLEY COLL. Abbotsford 853-7441.	
Intro to IBM PC & MS-DOS	
GUILDFORD CONT. ED. Centre, 14577 - 106A Ave.,	
Surrey, 589-2221.	
Computers made Easy: IBM-PC	
Lev.1 (Intro)	\$97
Lev.2 (MS-DOS)	\$97
PC Troubleshooting Lev.1	\$60
JUMP SYSTEMS Suite 450-650 W. 41st, Vancouver	
263-5867	
Computer Systems and DOS, OS/2	
KITSILANO NEIGHBOURHOOD HOUSE, 2325 W. 7th,	
736-3588	
Intro to PCs and DOS	\$120
KWANTLEN CONT ED/TLD LABS, 599-2501	
DOS Simplified, Mar 11-15	\$200
Intro to microcomp., Feb4-8	\$200
DOS/Lotus Comb., Fe25-Mar1	\$200
DOS/WP/Lotus, Feb4-8, aft.	\$200
LANGLEY COLLEGE, Langley 530-8411 Automated of-	
ice training for the disabled: visually or hearing impaired,	
physically disabled. Call for info, fees and dates.	
LANGLEY CONT. ED. 533-4227	
Understanding MS-DOS	\$85
MICROAGE 3609 W 16th 222-1010	
Intro to PCs/DOS,	\$175
NORTH SHORE CONT. ED.: 986-8888	
PBSC 900-885 W. Georgia 682-5615	
Intro to PC; DOS 3.3 & 4.0; L.1, 2 & 3	
PC Troubleshooting	
Windows 3.0	\$200/day

6ppm Laser Printer With Small Footprint Olivetti PG306

Basic units upgrade to PostScript. Ask us about upgrades.



Includes one-year on-site warranty

\$1495⁰⁰ PG306 512K

Expandable to 4.5MB
6 pages per minute
H.P. emulation

ASK ABOUT SPECIAL BONUS OFFER

FREE FONTS ETC.....

2.5MB

Postscript 35 resident fonts

\$2184⁰⁰

(150 sheets)

One paper tray does it all
8 1/2 x 11, 8 1/2 x 14, A4, B5
Prints 15 envelopes at a time



RENT ME!
\$95.00/MTH



Performance
A 32-bit Intel 80386SX



Run laps around the competition

The Everex Tempo LX is one of the first of a new generation of light but powerful notebook systems
2 inches x 10 inches x 12 inches 7 pounds.

BRAMALL BUSINESS SYSTEMS

4580 FRASER STREET VANCOUVER, B.C. 872-0255



Computer Professionals (Micro/Mini/Mainframe)
Technical/Network Support
Personalized Training

"Talk to the Specialists who speak Your language."

LESLEY BOYD LINDA BALDWIN
682-4571

K.E.I. Computer Center

SPRING SPECIALS

- KEI 25MHz ATURBO 386 System \$1599.00
- KEI 16MHz ATURBO 386 SX System \$1,288.00
- KEI 12MHz ATURBO System \$880.00
- 800x600 TVM Supersync 2A VGA monitor w/ATI VGA Wonder Card \$590.00
- 60MB Hard Drive 40 ms w/Card \$390.00
- Citizen GSX-140 Printer w/Cable \$399.00
- Citizen 200GX Printer w/Cable \$228.00
- Fujitsu DL-3400 Printer w/Cable \$459.00
- 1200 Baud Internal Modem \$78.00
- 2400 Baud Internal Modem \$90.00
- Logitech S9 Hi Res Serial Mouse \$80.00
- Dexxa Two Button Serial Mouse \$28.00
- 3.5" Diskette Box \$4.50

All ATurbo Systems come with 1MB RAM, 1.2MB Floppy Drive, 40MB 28ms Voice Coll Hard Drive, 12" Monochrome Monitor & 101-Key Enhanced Keyboard.

FREE Dexxa Two-button Mouse with any 386 computer purchased.

1139 E. HASTINGS ST. VANCOUVER, B.C. V6A 1S3

TEL: ☎ 253-2070 ☎ 251-7394

FAX: ☎ 251-6825

Proj. Mgmt: Timeline 4.0, 2-day	\$450
PCTI 520-6873	
Intro to DOS	\$100
PITMAN 1490 W. Broadway 738-7848	
Using MS/DOS days/eves.	\$180/120
PRECEPT 735 Clark Dr 255-3198	
Intro to IBM \$125; Power of MS-DOS	\$125
PROF. TRAIN. 502-1185 W Georgia, 681-5903.	
Intro to DOS \$175, Windows,	\$175
ROSSI, DEGROOT & ASSOC., 1099-650 W. Georgia, 683-0020.	
Intro to PCs, Intro to DOS, DOS Advanced	
SOUTH GRANVILLE 1652 W 7th 732-8850	
DOS 1 Call for dates	\$150
STM SYSTEMS CORP. 684-7721	
Intro to Computers \$140; DOS Intro	\$175
STRACHAN COMPUTERS LTD. #202-1760 Marine Drive, West Vancouver, B.C., 926-6424	
DOS, Maximizer, Windows	
SURREY (Newton Cont. Ed.) 594-2000	
Intro to IBM	\$85
Intro MS-DOS	\$85
TRITECH COMPUTERS Delta 597-4777	
MS-DOS 10 hrs.	\$99
UBC CONTINUING ED., UBC Microcomputer Lab, 222-5251	
Effective Project Planning, Feb. 28-Mar.1	\$460
MS-DOS Intro, Feb. 2	\$60
MS-DOS: Intermediate, Feb. 16, \$60	
Using Windows 3 w/Mouse, Feb.9, \$65	
VAN. COMM. COLL., 250 W. Pender St., 682-5844	
MS/PC-DOS, Intro., Interm.	\$150
Intro to PC & DOS	\$190
VCC CONT. ED. Certificate Prog. 324-5322	
Intro to DOS, Dec. 5, 9, 20	\$160
Intermed. DOS, Dec 1, 14	\$160

WORD PRO

ACCYS Suite 203, 535 Thurlow 685-5342	
WordPerfect	\$150
BCTEL GROUP, Education Development Centre \$200/day, 293-3636	
Word Perfect I, Feb 2	
Word Perfect II, Feb 9	
Word Perfect III, Feb 16	
BCIT, 3700 Willingdon, Burnaby, 434-1610	
Microsoft Word	\$101
WordPerfect	\$200
BCIT, Burnaby, 434-1610.	
Microsoft Word	
BURNABY SCHOOL BD., 299-4361.	
MS Works,	\$90
WordPerfect 5.0, Level II,	\$90
CAPILANO COLL. N. Van. 986-1911	
MS-Word L. I	\$140
CARIBOO COLL., Kamloops, 828-1916	
WordPerfect 5.0 Graphics	\$50
Word Proc.	\$160
CIRRUS ENTERPRISES, Victoria, 386-8844.	
DisplayWrite 4 Intro, DisplayWrite 4, Adv.	
Microsoft Word Intro, Microsoft Word, Adv.	
WordPerfect 5.0, Intro/Adv/Fast Track	
COASTWAY 2501 Spruce St., Van 736-5039	
WordPerfect 12 hrs, Microsoft Word 12 hrs, Advanced WordPerfect & Word, 9 hrs	
COMPUTER EMPIRE, 879-4162	
WordPerfect, WordStar	\$145
Chinese WP	\$185
COMPUTER STN 2130 Burrard 732-8621	
Intro to WordPerfect,	\$180
Intermed. WordPerfect,	\$180
CORP. PUB., 1500-701 W. Georgia St., 687-1140.	
Word for Windows, L.I. L.II call for dates	\$195
COQ. CONT. EDUC., 936-4261	

Word, Multimate, WordPerfect	\$80
DAC COMP. TRAINING, 682-2627	
DisplayWrite 4 & WordPerfect	
DOPPLER 101 W. 5th, Van 875-0261	
WordPerfect 5, Word	\$149

Our guarantee of the Best Computer Training
DOUBLE YOUR MONEY BACK!

WordPerfect Intro or Advanced

For \$149 we will Train You To Your Satisfaction or we'll give you a \$300 Refund. It's That Simple!
Lunch is served in our Air Conditioned Training Centre

Doppler 875-0261
COMPUTER TRAINING
101 West 5th Ave @ Manitoba St.

DOUGLAS COLLEGE, N. West, 527-5472	
MS Word, Mar 23	\$102
WordPerfect L.1, Feb4-18, M	\$115
WordPerfect L.1, Feb 16	\$102
WordPerfect L.3, Fe25-Ma11	\$115
DRAKE #601 889 West Pender 669-8789	
DisplayWrite 4: Word, Multimate Advantage, WordPerfect	
4.2/5.0/5.1: Legal; Smart Word Proc.	
FRASER VALLEY COLL, Abbotsford, B.C. 853-7441.	
Intro. WordPerfect	
GUILDFORD CONT. ED., Surrey, 589-2221.	
WordPerfect 5.1 Lev. 1, \$97; Lev.2, \$97	
JUMP SYSTEMS Suite 450-650 W. 41st, Vancouver 263-5867	
WordPerfect 5.0 and 5.1, Microsoft Word 5	
KITSILANO NEIGHBOURHOOD HOUSE, 2325 W. 7th, 736-3588	
Intro to MS Word 5	\$120
KWANTLEN CONT ED/TLD LABS, 599-2501	
MS Word L.1, Fe25-Mar1, 5 aft\$200	
MS Word L.1, Fe26-Mar5, 2 eve\$75	
Word L.2, Mar 12&19, 2 eves	\$75
LANGLEY COLLEGE, Langley 530-8411	
Word Proc.-Automated Office 120 hrs	\$330
LANGLEY CONT. ED. 533-4227.	
WordPerfect, Lev 1, 2,	\$85
Word Proc. Diploma Adaptive Computer Training for Disabled	
Upgrading to WordPerfect 5	\$40
Microsoft Word 5.0	\$105
WordPerfect	\$85
Section IV, Wed., 5:45 p.m.,	
Section V, Thurs., 5:45 p.m.,	
Section VI, Thurs., 8 p.m.,	
WordPerfect Weekend Fast Track	\$105
Section II, Sat. & Sun., 9:30 a.m.,	
WordPerfect, DTP Wed., 8 p.m.,	\$85

LEARN COMPUTER SOFTWARE

BY VIDEO PROFESSOR VHS TAPES

- Save Money
- Train on your own schedule
- In you own home or office

DOS, Spreadsheet, WordProcessing, Data Base
IBM, MACINTOSH, APPLE
Masako Holdings Ltd.

PHONE OR FAX (604) 275-1565

McKAY TECHNICAL INSTITUTE, 2151 Burrard, 736-7221

Word Perfect 5.1, 20 hrs.	\$250
MICROAGE 3609 W 16th 222-1010	
WordPerfect Lev.1, 2; Word V. 4.5,	\$175
Word Perfect 5.x. Lev 1&2	
MS-Word 5 Lev1	
Lotus 2.2/3 Lev 1&2	
dBase IV Lev 1&2	
Hard Disks & DOS Lev 1	
Page Maker 3.01 Lev 1	
Novell Net Ware Lev 1&2	
NORTH SHORE CONT. ED.: 986-8888	
PBSC 900-885 W. Georgia 682-5615	
Word for Windows, Word, WordPerfect	\$200
PITMAN 1490 W. Broadway 738-7848.	
Word Perfect 5.0 and 5.1. Days/ evenings \$120.00	
24hours/30hours \$275/\$299	
PRECEPT 735 Clark 255-3198	
Word Perfect 5.0 & 5.1 days/eves.	\$180/120
PROF. TRAIN. 502-1185 W Georgia 681-5903	
WordPerfect, MS Word, Multimate	
ROSSI, DEGROOT & ASSOC., 1099-650 W. Georgia, 683-0020.	
WordPerfect Level I, II & Graphics, Multimate L I&II	
MicroSoft Word 5.0, Displaywrite 4	
STM SYSTEMS CORP. 684-7721	
Microsoft Word, WordPerfect	\$175
STRACHAN COMPUTERS LTD. #202-1760 Marine Drive, West Van., 926-6424	
WordPerfect 5.0, Intro, Adv.	
UBC CONT. ED., UBC Microcomputer Lab, 222-5251	
MS-Word 5: Intermed. Skills Feb19-Mar 12 \$195	
WordPerfect 5.1: Lev.2, Feb.18-Mar11 \$195	
VAN. SCHOOL BOARD 736-7241	
MS-Word 5.0 (IMB)	\$90
MS-Word 5.0 (IMB) Lev. II	\$90
MS-Word 5.0, Bus. App.	\$90
Multimate 4.0 Level II	\$90
WordPerfect 5.1 Intro,	\$90
WordPerfect 5.1 Level II,	\$90
WordPerfect 5.1: Bus. App.,	\$90
DTP with WordPerfect 5.1,	\$90
WordPerfect 5.1: Macros,	\$90
VAN. COMM. COLL., 250 W. Pender St., Van. 682-5844. (Call for dates)	
WordPerfect Intro. & Fast Track, Interm	\$150
Adv. WordPerfect, WordPerfect 5.0	\$190
WordPerfect for Power Users	\$150
MS Word Intro., Interm., Adv.	\$150
Intro. to MS Works 2.0	\$150
WordPerfect for Power Users	
WORDROBE, THE, 270-1700	
WordPerfect, MS Word, DisplayWrite	
VCC CONT. ED. Certificate Prog. 324-5322	
Macro Programming,	\$160
Intermed. MS Word,	\$160
Adv. MS Word,	\$160
Intro to Word for Windows,	\$160
Intermed. MS-Works,	\$160
WordPerfect for Power Users -	\$160

UNIX

DRAKE #601 889 West Pender 669-8789	
UNIX: Overview; Intro.; Syst. Admin.	
JUMP SYSTEMS #450-650 W. 41st, 263-5867	
AT&T UNIX, SCO XENIX	
PLATON CONSULT., Burnaby, 420-8831.	
Unix/AIX: Micros to Mainframes,	
Unix/AIX: Concepts & Fund., UNIX/XENIX	
TRAINIX 926-8649 George Pajari	
SCO Xenix Sys Adm.,	\$1295
SCO Unix Sys Adm.,	\$1295
ROSSI, DEGROOT & ASSOC. 1099-650 W. Georgia 683-0021. Systems Management	

USER GROUPS

Amiga User Group (PaNorAmA), BCIT, Rm 129-1A. Gen. Meeting 2nd Wed 7:30; Programmers 4th Wed 7:30. Bill Wagstaff, 597-1746.	
Apple/ABCCS Meetings location: Burnaby Lake Club-house, Burnaby Sports Centre, Sprott St. & Sperling Ave.	
Apples B.C. Computer Society, Computer User Group for all Apple users, call 275-4983 information line; for membership info: Kiyo Masuda, 437-9935.	
Architect User Group (Macintosh). Call Glen Schiller or Kal Gill, Byte Computers, 738-2181.	
Astute—Atari ST. 1st Tues., 7:30 Hastings Comm. Ctr. Dennis 420-8710.	
ATARI USERS! Vantari, P.O. Box 3614 Main Post Office, Van., B.C., V6B 3Y6. Bill Sutherland 988-1450, Don Hatch 433-8055. Meets 2nd Wed., 7:30, Hastings Comm. Ctr., 3096 E. Hastings.	
Beaver Valley Commodore Club, 1st Tues., Montrose School Library. Call John Vink 367-6426.	
B.C. Regional Users Group Society of Hewlett-Packard Users.	
B.C. Unix Users Group Dinner Meetings. 681-4473.	
Chilliwack Commodore Computer Club (C.C.C.C.) - 976, Supporting Commodore Amiga, P.O. Box 413, Sardis, B.C. V2R 1A7.	
Data Processing Management Association (DPMA), Dinner meetings 4th Tues., every month, Stanley Park Pavilion. Next mtg Feb 26. Contact Frances Dickson 660-8668 to register, or Gail Nichols 660-9533 for information.	

FORTH-BC meets 7:30, 1st Thurs/month, Rm 1A-324, BCIT main bldg. Discussions, demonstrations and information for programming/applying FORTH (hardware and software).	
Greater Victoria Personal Computer Users' Assoc., PO Box 5309, Station B, Victoria V8R 6S4. General meeting, last Wed. Also, special interest group meetings 604-382-3934.	
Independent Computer Consultants Association, Box 820, Station A, Van., B.C. 682-2747. Fax 925-1336.	
Kaypro User Group/Vancouver Portable Computer Club, 3rd Mon., at Kwantlen College Richmond (DOS & CPM) 271-1519.	
Laboratory PC User Group, Rm 2J38, BC Children's Hospital, Vancouver. 7:00 pm, every 2nd Wednesday of the month, \$10/year 737-1305.	
Macintosh Owners - ABCCS contact person: John Miller 433-1795.	
MacWest Computer Society, 2 monthly meetings for members, plus PD copy session. General Meetings - 2nd Wed., 7:30 pm.	
MacWest New User Meeting - 3rd Wed., 8 pm, Guildford Pub. Lib., Surrey. PD Copy sessions & meet Ridge Computer User Group, 2nd Tues of every month, M.R. Sr. Secondary 7:30, J. Brohman 463-9318.	
NEC APC Users Group, Lee 980-5825.	

ELECTRONIC REPAIR

20 Years Experience

Call Roy at (604) 985-1626

VOICEMAIL

Inbound Info-Line, Outbound Telemarketing, Call Processing, Auto Dialed Paging ... and more. Complete Package \$350.

Demo/Order Line: (403) 569-2017

PC VOICE TECHNOLOGY INC.
Dealers Inquiries Welcome

Secured Data Systems Inc.

\$99.00

SPECIAL

IBM/Comp Intro. Course only \$119

3 HOURS OF INSTRUCTION ON YOUR FAVORITE SOFTWARE

Call Today **731-4026**

RECYCLED COMPUTER PAPERS

100% Recycled Fiber Unbleached or 50% Recycled Fiber White

All Formats Available.

Wholesale Inquiries

Welcome

873-5700



Software without Sweat!

Only \$5 for a sample issue of our newsletter *How to Create Better Software*. You'll enjoy it! Plus you'll gain new ideas, new programs, and new techniques to make your work easier.

Order now to benefit! Phone (403) 489-6711 with Visa/MC. Or send check/money order for \$5 to Automex Corporation, Newsletter Dept., Box 810, Edmonton, Alberta, T5J 2L4.

Dealer Inquiries Welcome

Vista Laser takes this opportunity to thank all of our customers for their continued and increasing support during 1990.

We have strived to provide the very best materials along with strict attention to detail, in order to make available, what we believe is the best quality recycled toner cartridge on the market.

Coupled with this, are fair prices on all our products and, our determination to back this up with excellent service.

We are therefore please to advise that any savings we receive from our supplies as a result of the GST system will be passed on to our customers, effective immediately.

We look forward to service you better in 1991.

The management and staff

VISTA LASER Tel: 273-5446 Fax: 273-5478

11-12171 Bridgeport Road, Richmond B.C.

The best in Quality & Service



CLASSIFIEDS



733-5596

FAX: 732-4280

Monday to Friday 9:00 a.m. - 5:00 p.m.



B.C. Edition: 50,000 copies monthly

Alberta Edition: 50,000 copies monthly

Hardware

CANNON BJ 10E PRINTER, never been used. Asking \$350. Call 589-5622.

LAPTOP TOSHIBA T3100 SX 16 MHz 40MB hard drive with case, DOS 4.1, mouse, Windows 3.0, all won in contest, never used. \$4800 OBO. 266-3433.

COMPAQ 29LB PORTABLE 8086 512K 2x51/4 clock inc DOS. Needs power supply. \$3000 OBO. By owner 732-7443.

DEMO SALE: Apple LaserWriter-\$1200, Apple Mac Classic 2/40-\$1900, Apple Mac LC 2/40 c/w Modem-\$1350, Radius full page display (Mac II) \$1295, RasterOps 19" Display (Mac II) \$1495, SuperMac 21" Display (Mac II) \$1895, Software PC Pagemaker \$565, Quark Xpress 3.0 \$800, Full Warranties. Call Altertext at 732-1416.

PC DESKTOP VIDEO 296/386 Genlock NTSC/VGA/VHS Animation, presentation, capture A/B dubbing. 436-3544.

XENIX THREE-USER SYSTEM, 68000 & Z80 processors, 768 RAM, 12MB hard drive, 5.25" floppy. Comes with MBSI (Real World) accounting software and more! I paid \$11,000, yours for \$995. Call Dale at 685-8684.



Why wait till SPRING!
Your **CLASSIC** can be here in **10** days
Call **WHITECAP SYSTEMS INC**
(604) 261-2209

NU-TEK COMPUTERS

"Where Computers Are Fun."

(604) 435-0113

3524 Kingsway, Vancouver B.C., V5R 5L7

At Nu-Tek, we believe in supporting the Amiga and Commodore Computers. That's why we have one of the largest selections of software in Vancouver. We also carry a large selection of accessories, books and magazines.

Authorized
Sales & Service
Centre

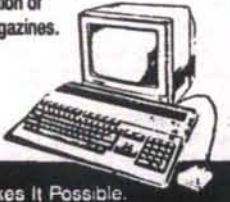

Only Amiga Makes It Possible.

AUTOCAD-MICROSTATION CONSULTING & SERVICES DRAFTING - SCANNING SERVICES

Custom Menus & Symbol Libraries
Training - individual or groups
DOS, LISP, UCL applications & tips to increase your productivity
installation & configuration of your new system

434-4273 OR 435-0714

COMPUTER MOBILE REPAIR

Specializing in IBM Compatibles
7 Days a week including evenings
on-site service for
home & small business

657-0811



- Consulting / Programmer
- Generic CAD Sales
- Training
- Design & Drafting Service
- CAD Equipment Sales
- Product Development

DEST: COMPUTER AIDED DESIGN
13484 72nd Ave., Surrey, B.C. 591-6650

Services

COMPUTER CONSULTANTS with expertise in any computer software, work on a freelance basis. 324-5834.

COMPUTER SUPPORT. Freelancers with software and experience in accounting, database management, word processing, desktop publishing. Your premises or ours. Low rates. 271-4276.

COMPUTER TRAINING, CUSTOM PROGRAMMING specialized in business applications. Call Dave 872-4027.

COREL DRAW one-on-one instruction, call 324-5834.

PROGRAMMER/ANALYST with 18 yrs exp, C, Assembler, Fox Pro, Adv. Revelation, COBOL. Integrity and knowledge. Call Bob at 873-6751.

TRANSLATION AND TERMINOLOGY SERVICES. For quality English to French translation by an accredited translator, please contact Joelle Lake, 4888 Northwood Place, North Van, V7S 3C4 Tel. 922-3119.

TOP NOTCH PROGRAMMER

Technical Excellence, Friendly Service
Small-medium businesses

dBase, Foxpro, C

Training

Call Dave Nelles

688-4142

Translation & Terminology Services

For quality English to French translation by an accredited translator, please contact
Joell Lake,

4888 Northwood Pl., N. Vancouver, V7S 3C4
922-3119

Best IBM SHAREWARE

low as \$2.50/Disk
Hundreds of Programs

FREE CATALOG

(604) 922-2743

Dover Micro P.O. Box 91789
West Vancouver, BC V7V4S1

Image Scanning

8bit/24bit Color & Grayscale scanning.
Displayable formats include VGA & Super VGA.
File conversions to TIFF, EPS, GIF, PCX, TGA,
etc. \$12 per image (volume discounts)

736-9624

COMPUTER TROUBLES?

APPLE & IBM COMPATIBLE SPECIALISTS
FACTORY TRAINED TECHNICIANS

WE DO MORE THAN JUST HARDWARE REPAIR.
We are a full service organization involved in all facets of the computer industry since 1977.

- WE ARE AFFORDABLE
- WE ARE FAST
- WE ARE EXPERTS
- WE DO IT RIGHT

"YOUR PLACE OR OURS"

MINITRONICS
HI-TECH SERVICES
1986 KINGSWAY
AT VICTORIA DR., VANCOUVER
872-5814

Software

HARVARD GRAPHICS package. Never opened \$250 eves 430-1614.

MACOLA
INCORPORATED

SALES • SUPPORT
CUSTOMIZATION

Get the top rated
accounting system
working for you.

NOW
With G.S.T. Processing

ALSOFT SYSTEM
ARTS INC. 261-5170

COMPUTER & SOFTWARE

Lowest prices on Macintosh, IBM, Compatibles, Toshiba, NEC, Sharp, QMS, Houston Instruments, Roland, CD-Roms, Scanners, Modems, Faxes, Hard Drives, Video Boards, Networking devices.

Call UCC, 13738 Artesia Blvd 150,
Cerritos, CA. 90701, USA.

Tel: 213-921-8900 Fax: 213-802-0831.

Worldwide sales. All products carry manufacturer's warranty.

FREE SHAREWARE 5-MEGS

With each 25MB Purchase, incredible assortment, IBM & Compatible, all are updated & virus free

200MB (240MB Total)	\$489
50MB (60 MB Total)	\$159
25MB (30MB Total)	\$89
Disk Catalogue with 1MB Utilities	\$10

CHK/MO/COD to: Computerized Graphics
19709-41A, Langley, B.C. Canada V3A 2Z5
(604) 530-3910 COD add \$5

Details Make The Difference

and YOU know what they are

Talk with us about

YOUR

software needs
because we'll build
a system that

YOU WANT

BCD SOFTWARE DEVELOPERS
(604) 872-4980

NEED EXTRA INCOME?

HOW TO EARN MONEY WITH
YOUR HOME COMPUTER.

Learn over 100 ways to financial freedom with your home computer. Free details. Write:

**HOME BASED BUSINESS
EDUCATION CENTRE**

246-8155 Park Road, Richmond, B.C. V6Y 3C9
or phone 279-9264

SHAREWARE SPECIALISTS

- Games, Graphics, Utilities, Windows, Music & Sound, Business, EGA/VGA, Adult and more for PC compatibles.
- Only \$3.95 per 5.25" disk.

**FREE
Demo Disk**

SPECIAL OFFER!

Send \$2.00 for our complete catalog, a \$5.00 coupon, and we'll give you a free demo disk.

You can choose one from the following:

1) Super Games 2) Mega-Utilities

\$2.00 is enclosed. Send me:

Super Games Mega Utilities

Name _____

Address _____

City/Prov _____

Postal Code _____

To: Nexiss Distributing, Box 590, #103-6411
Nelson Ave, Burnaby, B.C., V5H 4J9

Programmer Systems Analyst

Our client is a successful small business which develops and markets ACCPAC Add-ons from a rural community on a B.C. Gulf Island. The position involves management, product design and programming. The ideal candidate will combine at least two years of post secondary education in computer programming with a working knowledge of accounting. He/she is self-motivated, is prepared to relocate and merits generous compensation. Please forward your resume and salary expectations to:

Mr. William J. Swanson, M.B.A.

PACIFIC CONSULTING

530 South Alder St.

Campbell River, B.C. V9W 5W5

Phone: (604) 268-3222 Fax: 286-6945

GENERIC CAD Authorized Training Centre

For information,
call **DESJ Computer Aided Design.**
Bank Bestour: 591-6650.
13484 72nd Ave., Surrey, B.C. V3W 2N8

Donations

DO YOU WANT TO DONATE your XT IBM compatible computer/printer to seniors' center to enable seniors to learn/practice computer uses? Please contact Bob Cooper 469-1823.

Specialized Computer Bookstore

Free mail order 1991 Computer Book Catalogue is now available.

Unihall Computer
Books Co. Ltd.

682 Seymour St., Vancouver, B.C.
(Located downtown across from the Bay)

Tel: (604) 682-7842 1-800-663-0703

MENTEK

MENTEK

COMPUTER SYSTEMS

HIGH QUALITY • AFFORDABLE • EXCELLENT SUPPORT
 "A Commitment To Success"

MENTEK

"A commitment to success"

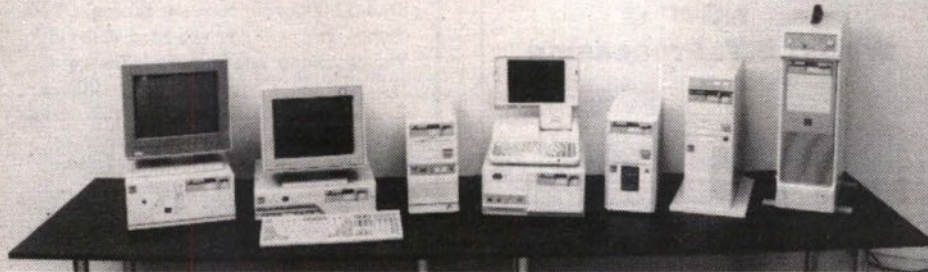

A full line of 286 to 486 EISA Computers Baby AT/SX

The full power of a 286/386SX in a small 10.5" x 12.5" x 3.25" case. Approx. weight: 15 pounds

9" Monochrome or Monochrome VGA display offered. Ideal for LAN, Executive Office, P.O.S. Schools, or anywhere you will have limited space.

A suggested retail price starting at \$1050.

New line of peripherals

- 4" floppy disk controllers
- pocket modem
- ethernet / arcnet cards
- New cases and power supplies

Thanks for dropping by the Mentek Booth at the Pacific Rim Computer Show.

DEALER INQUIRIES WELCOME.



Thank-you.

MENTEK SYSTEMS CORPORATION

373-13988 Cambie Road, Richmond, B.C. V6V 2K4
 Tel: (604) 276-8533 FAX: (604) 276-2992
 Alberta: (403) 438-4229

Office Hours: Mon - Fr: 8:30 - 5:30 Saturday: 9:30 - 12:30 (Oct. - Dec.)

#1 IN CUSTOMER SERVICE

COMPLETE SYSTEMS, PARTS & PERIPHERALS
 FULL SERVICE DEPT. & SYSTEM UPGRADES/REPAIRS

ACT 386/SX System
 New 1991 Model in Stock
 INTEL 80386SX-16 CPU
 1MB RAM on board
 1.2MB Floppy Drive
 40MB/28ms Hard Drive
 16-bit FD/HD 1:1 Controller
 AT-I/O parts
 256K VGA Card
 14" VGA Monitor Color
 101 Enhanced Keyboard
 Complete **\$1,850**

ACT 286/12 System
 New 1991 Model in Stock
 INTEL 80286-12 CPU
 1MB RAM on board
 1.2MB FD/40MB HD
 Serial/Parallel Ports
 101 Keyboard
 MGP Card
 14" Amber Monitor
 Complete **\$1,095**

We have all completed line of personal computers for 1991. From PC/XT to 80486 enhanced systems. Please call for prices.

PRINTER SPECIAL
 Panasonic 1124
 24-pin dot matrix
 LQ Printer
 Limited Stock **\$399**

VGA SPECIAL
 14" VGA Color Monitor
 256K VGA Card
 Complete **\$449**

WE UPGRADE & REPAIR YOUR PC
 Call our experienced technicians for FREE estimate & consultation. Hard Drives 20/30/40MB and up, Memory Expansion, Math Chips, Power Supplies and Add-On Boards. We have a full service dept. to provide you with quality service with low shop rates.
SERVING THE LOWER MAINLAND FOR 4 YEARS.

MONTHLY SPECIAL

Modems
1200/2400/int., ext.
Mice - All model
Joysticks
Laptop Computers
Larger Printers
FD/HD Drives
Keyboards
Software/Books

Please call for **BEST price**

IQ COMPUTERS SERVICES

985-6735
 M-F 10am-6pm • Sat 12noon-5pm

1551 Pemberton Ave.
 North Vancouver, B.C.



Fax 985-8726



Remember when computers were going to change the world.

Environmental disaster, famine, child abuse, homelessness.

The list of problems facing us is daunting. You can make a difference though. By joining CompuMentor you'll provide volunteer support to exciting, dynamic non-profit groups working to solve human problems. Join us today and help technology keep its promise.

Contact Arne F. Hermann,
 682-4149 or mail via MindLink

CompuMentor
 of Vancouver 328 W. Hastings St., Vancouver, B.C.

LASER CARTRIDGE RECHARGING • LASER CARTRIDGE RECHARGING • LASER CARTRIDGE RECHARGING • LASER CARTRIDGE RECHARGING

Stop Throwing Money Away

- Laser and PC cartridges & printer ribbons re-inking special
- Maintenance program
- HPI, II, & III Series Cartridges \$69.49
- Stan the "INK" Man - Doctor using Swiss Ltd. LC technology
- We ship anywhere you get this paper

NO TAX

100% Warranty for thirty days from date of purchase
 Drop Off At: Superior TV & Stereo 3571 #3 Rd. Richmond OR call pager #844-0261

TROUBLE WITH DATA ENTRY? LET US HELP YOU

- * Through our SCANNING process we will convert your written text or images into computer files.
- * Everything from memos and letters to books and magazines can be SCANNED in 1,000 typefaces and 16,000 font sizes at speeds up to 100 characters per second.
- * Your text or graphic can be converted directly into 50 different Word Processors, Spreadsheets, Data Bases, ASCII and Image Formats.
- * Other services include electronic forms, logos and programming.
- * Rate base on \$18.00 per hour.
- * All orders C.O.D. or pre-approved credit.
 8731 Minler Rd, Richmond, B.C.
 Tel: 275-2980



NETWORKING \$\$\$ & SENSE

VANCOUVER'S #1 NETWORKING COMPANY PROVIDES BEST PRICE, QUALITY, SUPPORT & PERFORMANCE

OUR NETWORK CLIENTS INCLUDE GOVERNMENTS, SCHOOLS, CORPORATIONS AND BUSINESSES.
WE HAVE POINT-OF-SALE PACKAGES FOR YOUR GIFT SHOP, VIDEO STORE, RETAIL GROCERY, GARAGE, CLOTHING OR JEWELLERY STORE, ETC.



NOVELL DISKLESS 3 USER SYSTEM \$5254

3Com



286 Novell



286 12MHz



286 12MHz



No. of Workstations	Arcnet Topology Diskless Boot	Ethernet Topology Diskless Boot	No. of Workstations	Arcnet Topology Diskless Boot	Ethernet Topology Diskless Boot
3	\$5,254	\$5,614	23	\$33,516	\$35,658
4	6,439	6,935	24	34,697	36,979
5	8,736	9,087	25	35,909	38,301
6	9,910	10,408	26	37,089	39,620
7	11,107	11,733	27	38,331	40,943
8	12,297	13,060	28	39,521	42,264
9	16,155	17,135	29	40,712	43,585
10	17,387	18,450	30	41,892	44,906
11	18,567	19,794	31	43,082	46,225
12	19,809	21,104	32	44,262	47,548
13	21,010	22,425	33	45,504	48,869
14	22,242	23,757	34	46,747	50,190
15	23,422	25,078	35	47,937	51,511
16	24,674	26,400	36	49,117	52,832
17	25,854	27,731	37	50,359	54,145
18	27,106	29,062	38	51,549	55,470
19	28,287	30,374	39	52,740	56,795
20	29,519	31,695	40	53,972	58,116
21	30,727	33,375	41	55,162	59,435
22	32,296	34,338	42	56,352	60,758

WE ARE DEDICATED TO NETWORK SOLUTIONS

150MB 17ms ESDI Harddisk upgrade on File Server	\$1390
320MB 18ms ESDI Harddisk upgrade on File Server	\$1995
620MB 18ms ESDI Harddisk upgrade on File Server	\$3600
MT-386 25MHz with 4MB RAM upgrade on File Server	\$1390
Remote File Server / Workstation Bridging	\$1500 plus modems
IBM Mainframe 3272 5 host session SNA Gateway Connection	\$3959
IBM Mainframe 3270 40 host session SNA Gateway Connection	\$7559

Networking Software:

dBase IV 1st User	\$645	ACCPAC PLUS	
each add. 5 users	\$848	G/L	\$638
WordPerfect 1st User	\$350	A/R	\$638
each add. user	\$220	A/P	\$638
MS Word 1st User	\$275	V/C	\$638
each add. user	\$200	J/C	\$710
Lotus 1-2-3 1st User	\$620	O/E	\$638
each add. user	\$310	Payroll	\$856
		LanPak	\$295

FILE SERVER CONFIGURATION: Multiterm MT286-12MHz O.W.S., 2MB, 1.2MB Floppy, 40MB 28ms Harddisk, Monochrome Display, Enhanced Keyboard, 2 Parallel & 1 Serial Ports, Arcnet Card. Novell Network Operating System, File Servers under 8 users are installed as NON-DEDICATED file servers.

WORK STATION CONFIGURATION: Multiterm MT286-12MHz O.W.S., 1MB (Max 4MB on board), Monochrome Display, Arcnet LAN card, 1 Parallel, Enhanced Keyboard, diskless, 20' cable MS DOS 4.01 and GW BASIC.

Onsite Hardware Installation Extra.

MULTITERM UNIX 5 USER SYSTEM

- 80386DX 16/25MHz O.W.S.
- 64K Cache RAM
- 4MB RAM 1.2 MB Floppy Drive
- 101 Click Keyboard
- 14" Monochrome Monitor
- 155MB 17ms Voice Coil Hard Disk
- Viper 150MB Tape Backup
- 4 Serial (tty) Ports
- 4 Wyse 60 Terminals
- SCO UNIX System V 3.2 O.S.

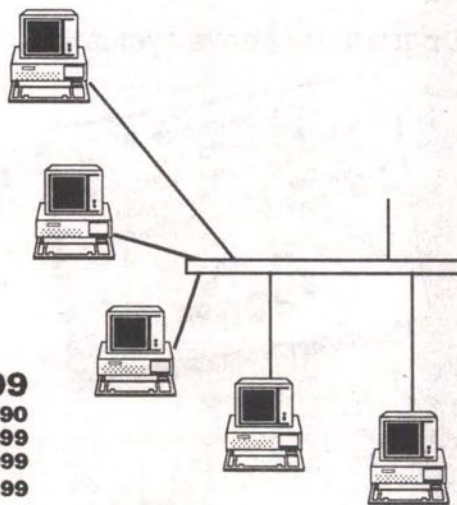

System Price: \$9999
 10 User w/ 8MB RAM: \$15990
 UNIX MS Word: \$499
 UNIX Foxbase Plus: \$999
 UNIX Professional: \$799



ONE YEAR PARTS THREE YEARS LABOUR ON UNIX SYSTEMS

We also network your Novell, Xenix, Unix servers through TCP/IP so that the work-stations can access server(s) of their choice, or, transfer files between servers, or access all the servers at the same time to perform multi-tasking and hot-key to different sessions with i80386 power. The user can access Oracle database located in the UNIX server(s) from the Novell Workstation without leaving the DOS applications. The user can also cross access between XENIX and UNIX without logging out.

Prices Subject To Change Without Notice.

COROLLARY

486/smp Symmetric, Compatible, Multiprocessor System

The world's first i486 symmetric multi-processor designed by Corollary, USA, supports up to 256 users. It grows with your business by just adding more processors. DPE Computers has integrated Corollary technology into the high performance MT-486MP. You can find out more about this exciting powerhouse by visiting us or calling 604-683-7587 (ext. 110).

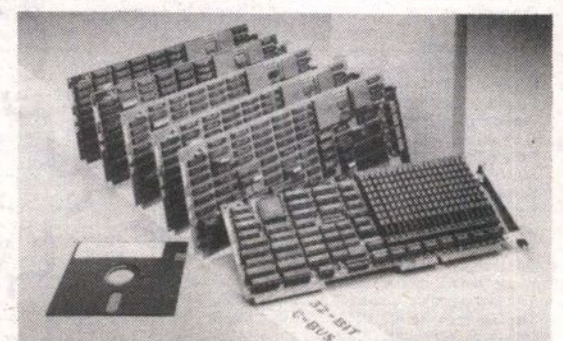

MULTITERM MT486MP

- 1 to 10 i486
- 64MB ECC memory
- Up to 3.6GB internal hard disk
- Supports up to 256 users
- High performance i486 SCSI
- High performance i486 serial I/O
- 32bit C-Bus
- 256K cache memory for each CPU
- Plug in standard PC I/O cards
- Runs off-the-shelf XENIX/UNIX

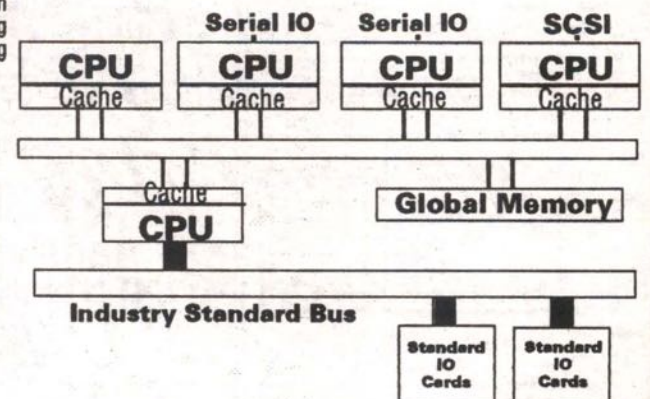

CMS Computers Plus Inc.
 #209 6th Ave. S.W.
 Calgary, Alberta T2P 0R2
 Tel: 403-237-0870 Fax: 403-237-0871

DPE COMPUTERS (Since 1983)

102-1112 West Pender, Vancouver, B.C. V6E 2S1
 Tel: 604-683-7587 Fax: 604-683-9210

Multiterm is a registered trademark of DPE Electronics Canada Ltd.

SEE OUR SYSTEMS AD page 4

Advertiser Index

ACCOUNTING	
Aisoft Systems	59
Healey, Seigneuret & Co.	12
Logical Methods	28
Syspro Canada	21
TXL Management	47
BOOKS	
Book Warehouse	2
Cody Books	59
Doppler Computer Centre	15,58
Unihall Computer Books	59
DESKTOP PUBLISHING	
DEST Computers	59
Lazer Set	13
Altertext	44
First Image Group	13
Graphic Resource Group	56
Laser's Edge	7
QMS Canada	49
Scan Master	60
Vision Presentations	46
EVENTS	
Swap Meet	30
HARDWARE AND SOFTWARE	
3D Micro Systems	33
AE Electronics	26
Alliance Business Computer	29
Alpha Computer	2
Ano Automation	2
Arete Computers	36
ATIC Computer	42
BCD Software Developers	59
Bramall Systems	57
Buy & Sell Press	43
BYTE Computers	34
Campus Computers	62
Canada Portable Computer	36
Cardz Computers	3
Carillon Music	39
CCS Computer	25
Compatible Computers	28
Compuage	51
Compumax	11
Computer Empire	6
Computer Exchange	63
Computerized Graphics	59
Compuwork	30
ComStar Distributors	43,50
Comtech Distributors	56
Comtex Micro	32
Datatronix	44
David Neises / Den Pac	59
Doppler Computer Centre	64
DPE Electronics	4,61
Express Micro	50
Focustronics Inc.	41
Friendlyware Computers	2
Fujikama	40
GXR Systems	27
Help Software	18
Impaq Technology	8
Infospec Systems	29
Intelligent Solutions	53
IQ Plus Computers	60
John Hall	59
KEI Computers	57
Lingo Computers	48
Megatronics	16
Mentek Systems	60
Minitronics	35,59
Morse-Tech	31
Mountainview Dataworks	27
National Computer Products	54
New Tech	47
Northwest Information	47
Nu-Tek Computers	59
Omninet Computer	10
PC Computer	53
Peap Computer	43
Phase 1 Systems	19
Polytech Communications	37
PowerSoft Systems	27
Publishing Technology	38
Q by Javell	9
Roland DG	17
Sector Technologies	55
Software BC	46
Software Warehouse	55
Sovo Computer Centre	12
Standard Computronics	22
Strachan Computers Pal286	23
Super Store	14
TGI Technologies	24
The Computer Store	24
Universal Technology	52
Vantage	20
Varsity Computers	42
Versatile Computer Products	13
Westcoast Computers	19
Whitecap Systems Inc	59
WKK Systems	48
Zegna Electronic	42
NETWORKING	
Vancouver Netware Users Group	58
ONLINE	
Mind Link!	35
SERVICES	
Executive 1 Business Centre	36
Paper Choice	59
Regent Computer	30
Stan the "Ink" Man	60
Superior Laser Supply	7
Vista Laser	43,58
SHAREWARE	
Doug & Colleen's	24
Dover Micro Ltd.	59
Gemini Marketing	53
Nexiss Distributing	58
Sim Com Shareware	46
Universal Computer	59
SUBSCRIPTIONS	
The Computer Paper	8
TRAINING	
CPET Publications	56
Masako Holdings	58
Office Automation	57
Quartech Systems	56
R.J. Norman	57
Ross, Degroote, & Associates	27
Secured Data Systems Inc.	59

PUZZLED!?!?

We'll help you put together the pieces!

JUST ARRIVED!

486-25MHz/40MB
with monitor
• 4MB RAM
• 25MHz clock speed
• expandable to 8MB
\$2799

386DX-25MHz
Cache /40MB
with monitor
• 1MB RAM • 64K cache
• 25MHz clock speed
• expandable to 8MB
\$1599
386DX 33MHz-Cache/40MB \$1988

386DX 25MHz/40MB
with monitor
• 1 MB RAM
• 25MHz clock speed
• expandable to 8MB
\$1488

386SX 16MHz/40MB
with monitor
• 1 MB RAM
• 16MHz clock speed
• expandable to 4MB
\$1199
386SX 20MHz \$1478

286 12MHz/40MB
with monitor
• 1 MB RAM
• 12MHz clock speed
• desktop case
\$799
286 16MHz/40MB \$999

2400 Baud Internal Modem w/Software (Hayes Compatible)
\$7800

All Models Feature:

- 12" Monochrome Monitor • Hercules Compatible Mono/Graphics Card
- 101-Key Enhanced Keyboard • 1024K RAM / 0 Wait State • 1.2MB Floppy Drive
- 40MB Hard Drive (28ms) • Combined Hard / Floppy Controller • Serial/Parallel Ports
- User's/Technical Manuals • 1 Year Parts & Labour Warranty

Upgrade for above systems:

VGA Package EL:

- 640*480 Resolution
- OAK VGA (256K, 16-bit)
- Samtron SC-441V VGA Colour Monitor
- 14" Monitor with Tilt/Swivel Base
- .41mm Dot Pitch
\$24000

VGA Package B:

- 1024*768 Resolution
- ATI VGA Wonder (512K, 16-bit)
- TVM 3A VGA Colour Monitor
- 14" Monitor with Tilt/Swivel Base
- .28mm Dot Pitch
\$39800

Motorola \$540
8000M \$888
Talkman \$1288
PT-500 \$1388
Mitsubishi 99X \$1388

All phones come with Canadian warranty. Must be activated by Campus Computers & Cintel

Panasonic 1180
\$18800

COME SEE US AT U.B.C.

CAMPUS COMPUTERS

2162 Western Parkway
Vancouver, B.C. V6T 1V6
HOURS: 9:30 am - 5:30 pm
Mon-Fri.,
10:00 am-4:00 pm Sat.
FAX
228-8338
228-8080

We Do Our Homework

CANTEL APPROVED AGENT

7 GREAT REASONS

TO SHOP AT COMPUTER EXCHANGE

- 1 EVERYTHING'S QUALITY** - tested by fanatics. We pre-screen everything we sell for compatibility and reliability. We hate problems even more than you do.
- 2 IN HOUSE & ON-SITE SERVICE** - We have technicians and diagnostic equipment to perform work in-house that other places have to send out. And now, we offer optional on-site service to get you up and running even faster.
- 3 IN BUSINESS SINCE 1985** - We are B.C. owned and operated, and we know how much you hate to see computer companies come and go.
- 4 FAST DELIVERY** - We can deliver your new system to you in an average of three (3) working days.
- 5 FULL COMPATIBILITY GUARANTEE** - We guarantee that it will be able to run any IBM software without modification or your money back.
- 6 ONE HOUR WALK-IN REPAIR TURNAROUND** - Most repairs take on average one hour. We replace most components so that we can fix them on our time, not yours.
- 7 FREE LOANER SYSTEM** - If we cannot repair your system within two days, we will loan you another system until your system is repaired.

CEX 486 MULTI-USER SYSTEM

- Intel 80486-25 CPU Running @ 25MHz
- Built-in math co-processor
- 8KB Internal cache, 128KB external cache memory
- Socket for Weitek 4167 Coprocessor
- 4MB RAM expandable to 16MB
- Rodime 110MB 18ms 64K Cache HD
- 1.2MB TEAC Floppy Drive
- Focus 2001 Enhanced Keyboard
- Tricom Mega VGA 1MB video RAM
- Super VGA Monitor .28mm (1024 x 768)
- Full size tower case w/220W p.s.

\$4,295.00

* The computers are not exactly as illustrated

CEX 386 25MHz SYSTEM

- 80386-25 CPU, AMI 386 BIOS
- 1 MByte RAM, 0 Wait States
- 1.2 MByte Floppy Disk Drive
- 65 MB Mitsubishi RLL Hard Drive
- Focus 2001 Enhanced keyboard
- 200 Watt Power Supply (CSA Appr.)
- Mini footprint desktop case
- 16-bit VGA card w/512K
- 14" color monitor (1024x768) .28mm
- 1 Year Parts & Two Year Labour Warranty

\$2,125.00

FOR 80386-25 (WITH 64K CACHE) ADD \$250.00

SUPER DEALS!

CEX 386 33MHz Cache 64

- 80386-33 CPU, 0 Wait States
- 64 KB Cache RAM
- AMI 386 BIOS
- 1 MByte of RAM
- 110 MByte Hard Disk, 18 ms, Voice-Coil, IDE
- 1.2 MByte Floppy Drive
- Enhanced Keyboard
- 1 Serial, 1 Parallel, 1 Game Ports
- 8 Expansion Slots
- 1024 x 768 Super VGA Monitor w/ 512K VGA card
- Mini Tower Case
- One Year Parts and Two Year Labour Warranty

\$2,750.00

CEX 386SX-20MHz

- Intel 80386SX CPU • 20 MHz Clock Speed
- Zero Wait State • AMI BIOS
- 1 MByte RAM
- 1.2 MByte Floppy Disk Drive
- 42 MByte Hard Drive (Fujitsu voice coil, 25ms, 1:1, IDE)
- Enhanced Keyboard
- 1 Serial, 2 Parallel, 1 Game Ports
- 8 Expansion Slots
- 200 Watt Power Supply (CSA Appr.)
- Mini footprint desktop case
- 16-bit VGA card w/256K
- 14" VGA color monitor .31mm
- Ram Expandable to 8 MByte on Motherboard

\$1,820.00

CEX 386SX-16MHz

- Intel 80386SX CPU • 16 MHz Clock Speed
- 1024K RAM, 42 MB Fujitsu HD, voice coil, 25ms, 1:1, IDE
- 1.2 MB 5.25" or 1.44MB 3.5" Floppy Disk Drive
- 101 key enhanced keyboard
- Oak VGA card w/256K
- 14" VGA color monitor .31mm
- Mini desktop case, 200 W CSA PS

\$1,620.00

CEX 286 16MHz

- Intel 80286 Microprocessor
- 16 MHz Clock Speed • Zero Wait State
- 1024K 100ns RAM • 42 MByte Hard Drive (Fujitsu, 25ms, 1:1HD)
- 1.2 MByte 5.25 TEAC Floppy Drive
- 101 Key Enhanced Keyboard
- Oak VGA card w/256K
- 14" VGA color monitor .31mm
- Serial (RS232C), Parallel (Centronics) & Game Port (15 Pin)
- Mini Footprint Case • CSA Approved Power Supply

\$1,299.00

CELLULAR PHONES

- (must be activated by Computer Exchange)
- | | |
|----------------|---------|
| 8000M | \$595 |
| Talkman | \$899 |
| NEC P300 | \$1,222 |

ALL MOTOROLA PHONES CARRY 3 YEAR CANADIAN WARRANTY: WITH FREE LOANER UNIT WHILE IN REPAIR.

ALL CEX COMPUTER SYSTEMS ARE COVERED BY A ONE YEAR PARTS AND TWO YEAR LABOUR WARRANTY, TWO YEAR PARTS AND LABOUR WARRANTY ON RAVEN PRINTERS. CASH AND CARRY ONLY.

4 USER NOVELL NETWORK SYSTEM



\$5,995

CEX NETWORK SERVER - 386

- 386/25MHz CPU
- 2MB Memory
- 1.2MB Floppy •
- 110 MB Hard Disk
- Mono Display • Arcnet card

WORKSTATION 286/12

- 286/12 Processor • 1MB RAM
- Mono Display • 1.2MB Floppy
- Arcnet card

ASK ABOUT ACCPAC+ UPGRADE FOR GST ACCPAC® Plus Authorized Dealer

NEW \$1,450

The first in the new generation of Raven Laser printers, the LP-800 gives ultimate power in a low-priced desktop laser. Speed of 8 pages per minute, a 250 sheet paper tray, and 11 built-in fonts are just a few of this printer's exceptional features.

LP800

EASY ENVELOPE PRINTING WITH MANUAL FEED

FAX MACHINE BRAND NEW

SPECIAL SALE

\$599.00

COMPUTER

HOURS

MON-FRI 10-6
SAT 10-5
SUN CLOSED

EXCHANGE

**DOWNTOWN
650 SEYMOUR**

Ph. 683-1788

FAX order line: 683-1333

BROADWAY

1041 W. BROADWAY

Ph. 733-1535

Fax order line: 733-5130

EDMONTON OFFICE

13222 - 118TH AVE., EDMONTON, ALTA. PH: (403) 453-6844 FAX: (403) 454-6137

DISCOUNT PRODUCTS COMPUTER

OPEN EVERY DAY

THE LARGEST FULL STOCK FULL SERVICE COMPUTER STORE!
2000 Products in Stock
VISA
MasterCard
We Ship International

7 DAY A WEEK SERVICE

WE BEAT PRICES!

INTRODUCING MAC SOFTWARE

NOW AT DOPPLER

WE SHIP ANYWHERE!

DOPPLER now carries a limited stock of the HOTTEST MAC TITLES at cut-throat PRICES!

MAC SOFTWARE

- Anti Virus (Symantec) 79
- AppleShare PC 99
- Excel Mac 239
- FileMaker II 335
- Generic CADD Mac 320
- MacDraw II 332
- MacLink 119
- PageMaker Mac 579
- Pyro 97
- Quark XPress 172
- Super Paint 198
- Adobe Type Manager 89
- Adobe Type Manager Plus Fonts 146
- Ventura (Mac) 699
- Wingz Mac 279
- Word Mac 239

Mac Books and Games, too!



CD-ROM

Breakthrough Technology! CD-ROM \$349



PRINTERS

FULL COLOR KODAK PRINTER \$498



WARNER SYSTEMS 386 & 486

- WARNER 386SX**
1MB RAM • 32K cache
• 40MB Drive
• Mono Graphics
\$1449
- WARNER 386-33**
1MB RAM • 128K cache
• 40MB Drive
• Mono Graphics
\$2169
- WARNER 486-25**
4MB RAM • 128K cache
• 40MB Drive
• Mono Graphics
\$3789



WOW!

Imagine running your TV or VCR running under WINDOWS on your monitor—with full capture ability \$49 TV Tuner \$479



LASERS

BELIEVE IT! PostScript at an unheard-of price. The NEC 290 PostScript Laser \$2388 Sold in December for \$3888



COLOR LASER

SEE the incredible Sublimation Printer OUTPUT!



MONITORS

Prices start at under \$400 for FULL COLOR VGA



SCANNERS

SCAN and CREATE your own COLOR separations



ACCESSORIES

NEW Windows lightpen \$499

Unbeatable PRICES at

DOPPLER COMPUTER CENTRE

Okidata LASER
5 Year Warranty
17 Fonts
HP Quality Print
HP Emulation
PC Mag Editor's Choice
\$999

Ultralite LAPTOP
NEC 8086C
2400 Baud Modem
2MB RAM Disk
3.5-inch Drive
List Price \$5999
\$1249

Colorado TAPE DRIVE
Up to 120MB
Safe & Easy
Uses Data Cartridges
External Kit Available
Super Low Price
\$398

IN STOCK SELECTION

- 1MB DRAM Chips .109
- CMS Stereo Chip .45
- 1.44MB Drive .105
- 8.5 x 11" Scanner .899
- T1000LE Laptop .2375
- 286 Math Chip .299
- Flight Yoke .99
- Track Ball .115
- LogiMouse .99
- USR 14.4 Modem .798
- ATI VGA Wonder .229
- Prices Subject to Change

The POWER LIST

DISCOUNT SOFTWARE
IN STOCK SELECTION

101 Macro's Lotus/ WP5.1	59/59	Desk-Link (mini network)	139	Language Master (Franklin)	119	Quick C with Assembler	169
20/20 v2.3	379	Desqview v2.3 / 386	115 / 189	Lap-Link III (laptop files)	119	Quick History v6/Transfers v6	289/289
3 for 3 (runs Lotus under Windows)	99	Direct Access v5 / Network	79/219	Lattice C Compiler v6.0	239	Quick Invoice v5/Reports v6	259/289
386 To The MAX v5.0	129	Disk Optimizer v4.0	89	Lazy Susan New	68	Quick Pascal	79
Above Disk (Creates LIM 4)	98	Disk Technician Advanced	139	Le Menu (easy menu)	79	Quick Schedule Plus (scheduler)	68
Above Lan/Above MEM	429/69	DOS (Dr) v5.0	165	Learning Dos (Microsoft)	44	Quicken (best value acctg)	45
ACCPAC BPI (per module)	285	DOS 4.01	88	Letter Perfect (WordPerfect)	179	R Base for Dos	599
ACCPAC Graphic Reporter for GL	139	DOS Tutor DS (DOS Trainer)	36	Letters On Line (pre-written)	49	R/R Code Generator	139
ACCPAC+ 5.1 (C/UC/DE/Fri-va)	619	Double Disk (doubles H.Disk)	98	Look & Link (for Lotus)	79	R&R v4.0 New (with Fox & Clipper)	199
ACCPAC+ 5.1 PAYROL/Sales	795/539	Double Dos v5.0 (run twice)	89	Lotus 1-14Ea	529/259	Rapidfile (mail database)	249
ACCPAC+ 8.0 GL/AP/AR-va	619	DrawPerfect (for WP5)	329	Lottery Trend Analysis	19	ReadyWrite v2.01 (OCR/Windows)	399/598
ACCPAC+ 6.0 Window / LAN	179/349	Dream House CADD	25	Lottery Trend Expert	49	Reflex 2.0	219
Act V2.0 (Best contact manager)	359	Dream House Professional CADD	69	Lotus 123 Upgrade any version	169	Resume Maker (by Individual)	44
Action Planner (power up)	89	Eight-in-One-New (integrated)	65	Lotus 123 v2.2	399	Revelation Adv. Bump Disk	539
Address Book Junior / Senior	79/99	Encyclopaedia Random House	98	Lotus v2.2 Node / Network	259/549	Revelation Adv. v2.0/Runtime	775/168
Adlib Instrument Maker/Composer	45/85	Ensemble GEO Works NEW (Fantastic)	198	Lotus v3.1 Windows	499	Rightwriter 3.0 (Grammar checker)	89
Adobe Illustrator Windows	469	Excel Microsoft Windows	279	Lucid 3D v2.0 (top rated)	96	Ryan McFar. Cobol v5.0 / Run	1098/149
Adobe Type Manager	89	Excel v3.0 New Version	379	Mace Utilities 1990	119	SCO Xenix Dev 286 / 386	549/629
Adobe Type Manager Plus Fonts	146	Express Publisher (DTP)	139	Macro Assembler v5.1 MS	129	SCO Xenix OSYS 286/386	529/579
Agenda v2.0	349	Eye Relief for Laptops	125	Magellan v2.0	129	Show Partner FX v3.5	299
Always for Lotus v1.2 / Symp	159/159	Face Lift (Bistream Type Manager)	89	Managing Your Money v6	179	Sideways / Plus (organizer)	85/168
Amarillo Slim Poker	49	Family Fortune (plan & track)	59	Manifest (memory Mapper)	54	Sideways v3.2	59
Ami Professional Windows	399	Family Reunion (plan & track)	59	Manuscript	389	SiBack (Automatic backup)	99
Amortize (Canadian Loans)	79	Family Tree (maker)	69	Mail Cad v2.5	389	Small Talk / 286	99/189
Animation (by Deluxe Paint)	129	Fantavision (animation)	69	Maxiv Beacon Teaches Typing	49	Smart Spreadsheet	299
Animator (by Autodesk)	275	Fastback Plus v2.1 New	149	Maximizer v2.2 / Network	169/459	Smart System (new Ver.)	599
AntiVirus Norton (kill Viruses)	119	FastLynx (file transfer)	79	Memory Mate (random manager)	79	Smartern 220/240	98/249
Applause II (more power than Harvard)	379	FastPac Mail (mail list)	79	Meta v1.1 (like sidekick)	79	SoftSafe v2.0 (system security)	124
Artline for GEM	329	File Shuttle v5.0	109	Modula II (by Logitech)	114	SoftType (Z-soft Fonts Windows)	179
Asksam (smart database)	229	File Shuttle Windows	119	Mouse Programming Reference	39	Software Bridge (wp Convert)	119
Autosketch v3.0	199	Financial Calculator (Tobias)	49	Move Em (RAM Control)	75	Software Carousel v4.0 new	89
Backup (new by Central Point)	79	Finical Forecast (power up)	79	Multimats Adv III v4.0	369	Spinnits II (ncrose HP spd)	99
BannerMania (fantastic banners)	49	Name Tag Kit (makes name tags)	89	Magellan v2.0	129	Splash VGA Paint	89
Basic Compiler v7.0 MS	379	Newsman II	69	Magellan v2.0	129	SOZ Plus (compress Lotus)	99
Battery Watch (extend battery life)	45	No Squire (laptop cursor)	39	Manuscript	389	Stedmans Legal Dictionary	89
Bedford ACCPAC (GST)	149	Norton Backup	129	Mail Cad v2.5	389	Stedmans MEDICAL Dictionary	79
Bedford Report Writer	89	Norton Commander v3 NEW	115	Manuscript	389	Straight Line Windows	89
Betrieve / Network	199/469	Norton Editor v2.0	9	Maxiv Beacon Teaches Typing	49	StreamLine (vectors Scans)	348
Bible Hebrew Dictionary	109	Norton Guides C / Pascal / DOS	48/48/48	Maximizer v2.2 / Network	169/459	Success (by Phoenix-Business Plan)	59
Bible Soft Study for PC	149	Norton Guides Lotus / dBase	48/48	Memory Mate (random manager)	79	Success Inc (financial plan)	89
Bitstream Headlines 1	189	Norton Utilities v5	135	Meta v1.1 (like sidekick)	79	Super Base 2 / 4 windows	259/498
Bitstream WP 5.1 Install Kit	69	Novell Networking	call	Modula II (by Logitech)	114	Super Video Editor/Developer	359/595
Blacks LAW Dictionary	89	OmniPage v2.1 / Pro	798/988	Mouse Programming Reference	39	Supercalc 5.0 (super value)	299
Bon Appetite (Cooking Book)	49	One Person Office	69	Move Em (RAM Control)	75	SuperKey (great macro maker)	98
Bridge Barron II	49	Optune (drive checker)	89	Multimats Adv III v4.0	369	Superproject Expert/Plus	525/299
Brief v3.0 (for DOS)	209	Org Plus Advanced	119	Spinnits II (ncrose HP spd)	99	SUZU (on-line service)	29
Brooklyn Bridge (file transfers)	119	Form Finisher (power up)	59	SOZ Plus (compress Lotus)	99	Symphony 2.2 Plus	585
Budget Express (for Lotus)	125	Form Publisher Windows	189	Stedmans Legal Dictionary	89	T-MAN V2.0 Point of Sale	599
C Compiler v6 Microsoft	369	Formbase (Database forms)	428	Straight Line Windows	89	Teach Yourself Lotus/WordPct	59/59
Calendar Creator Plus	179	FormGen Plus v5.0	179	StreamLine (vectors Scans)	348	Timeline 4.0 with Graphics	529
Carbon Copy Plus v5.2	149	Formtool Gold	89	Success (by Phoenix-Business Plan)	59	Timeslips III v4.0 New	298
Carman Santiago World (VGA)	69	Fortran v5 Compiler MS	369	SuperBase 2 / 4 windows	259/498	Timeslips Remote (TSR version)	79
Catchword (OCR Reader SW)	198	Fox Graph (for Foxbase)	239	Super Video Editor/Developer	359/595	Tool Book (for windows)	419
Certificate Maker	39	Foxbase + 2.1 / LAN	269 / 399	SuperCalc 5.0 (super value)	299	Top Priority (planner)	78
Chain of Command (planning)	127	FoxBase 386 v2.1	379	SuperKey (great macro maker)	98	Touch Up (clean up scanned img.)	189
Charisma / Node	429/299	FoxBase Run/Pro RunTime	349/399	SUZU (on-line service)	29	Trading Places (tsr Database)	75
Check Book (My)	26	FoxPro / FoxPro LAN	599/879	Symphony 2.2 Plus	585	Treasuries (My) property tracker	26
Check 1/PC Diagnostics	49	FoxPro R/F Runtime	388	T-MAN V2.0 Point of Sale	599	Tree Saver (great paper mangr.)	89
Check Writer Plus (Tobias)	49	Framework III / Personal XE	499/129	Teach Yourself Lotus/WordPct	59/59	Turbo C++ / C++-Professional	175/269
ChessMaster 2100 / Battle	54/54	Freelance v3.1	389	Timeline 4.0 with Graphics	529	Turbo Debugger Tools	148
Clarian Developer / Pro v2.1	165/899	Friday Night Poker	38	Timeslips III v4.0 New	298	Turbo EMS Memory Manager	95
Clickart Business Images/Holiday	69/89	Game Shop MS	56	Timeslips Remote (TSR version)	79	Turbo Lightning (spell checker)	99
Clickart EPS Business Images	129	Generic * 3D Drafting	289	Tool Book (for windows)	419	Turbo Pascal 6.0 / Prof	129/279
Clickart EPS Illustrations	129	Generic * Cad Level 5 NEW	298	Top Priority (planner)	78	Turbo Pascal 6.0 / Prof	129/279
Clickart Personal / Publications	89/89	Generic 3D Symbols Pack	75	Touch Up (clean up scanned img.)	189	Type (Broderbund)	39
Clickart Windows 3 Clipart	89	Generic AutoConvert	89	Tree Saver (great paper mangr.)	89	Typing Tutor IV Plus (NEW)	39
Clipper v5.0 new	599	Generic Home Design / Bathroom	59/59	Turbo C++ / C++-Professional	175/269	Ultra Vision (VGA screen enhancer)	126
Close Up Customer / Support	169/219	Generic Home Furnishings	59	Turbo Debugger Tools	148	Vaccine Norton (Virus finder)	79
Close Up Network (8 user)	739	Generic Home Landscaping	59	Turbo EMS Memory Manager	95	Ventura Gold v3.0 Windows	599
Cobol 3.0 Compiler MS	749	Generic Kitchen Design	59	Turbo Lightning (spell checker)	99	Vista Companion (reviews videost)	69
Compuserve Subscription Kit	39	Generic Residential Framing	59	Turbo Pascal 6.0 / Prof	129/279	VP Planner 3D (spreadsheet)	218
Control Room (control your PC)	119	Gofer 2.0 (find any file)	65	Type (Broderbund)	39	Watch Dog (NEW) security	229
Cook Book (fantastic food)	39	Grammatik IV DOS / Windows	79/79	Typing Tutor IV Plus (NEW)	39	Who When (time manager)	249
Copy II PC Option Board (+Mac)	169	GrandSlam Bridge	219	Ultra Vision (VGA screen enhancer)	126	Windows 3 Developer	498
Copy II PC v6.0	39	Grandview (organize/ track)	219	Vaccine Norton (Virus finder)	79	Windows 3.0 MS (a must have)	99
CopyWrite (NEW version)	89	Graph in a box Windows	119	Ventura Gold v3.0 Windows	599	Windows Entertainment MS	38
Corel Draw v2.0 / OS/2	529/475	Harvard Graphics v2.3 LAN	339/775	Vista Companion (reviews videost)	69	Windows Express v3	65/65
Corporate Ladder	76	Harvard Node	349	VP Planner 3D (spreadsheet)	218	Windows Utilities MS New	59
Crosstalk Communicator	85	Harvard Project Mgr 3.02	579	Watch Dog (NEW) security	229	Windows WinFax	99
Crosstalk MK IV / XVI	179/144	HeadRoom v2.0	95	Who When (time manager)	249	WinFax (windows fax software)	48
Crosstalk Windows v1.1	169	HiJack (graphics screen grabber)	185	Windows 3.0 MS (a must have)	99	Word 5.0 (great value)	189
CrossWord Magic (make Xwords)	54	Home Finance Manager (planner)	25	Windows Entertainment MS	38	Word 5.5 New (graphical interface)	269
Current (IBM)	299	Home Office Manager (integrated)	25	Windows Express v3	65/65	Word For Windows	339
Dac Easy Acting v4 / Payrol	149/109	HomeTax (Cdn. Tax Planner)	59	Windows Utilities MS New	59	WordPerfect 5.0 French	299
Database v4.2 (Great Product)	689	HotWire (file transfer)	119	WinFax (windows fax software)	48	WordPerfect 5.1	279
dBase III Plus	499	HyperPad v2 (ie Hypercard)	139	Word 5.0 (great value)	189	WordPerfect 5.1 Node	199
dBASE IV Dev. Edition	959	InfoSelect (thought manager)	98	Word 5.5 New (graphical interface)	269	WordPerfect 5.1 UPGRADE	149
dBASE IV v1.1 / LAN	539 / 759	Jet Propulsion (speed up Laser)	96	Word For Windows	339	WordPerfect Office New	119
dBrief v3.0	169	KeyWords / Advanced	88/179	Windows Entertainment MS	38	Wordstar Professional 6.0	249
Deluxe Paint II Enhanced	119	Kitchen Companion (cooking)	39	Windows Express v3	65/65	Working Hours (work hours planning)	79
DesignCad v4.0 2d	249	Label Maker (My)	36	Windows Utilities MS New	59	Works 2.0 (top integrated)	139
Designer v3.0 (Micrograph NEW)	549	Labels Unlimited v3.0 great!	69	WinFax (windows fax software)	48	WorkSheet Utilities	85
				World Atlas	56	World Atlas	56
				Xtreme Pro Gold / Network	109/479	Xtreme Pro Gold / Network	109/479
				XY Write III+ w/Ala Cart	319	XY Write III+ w/Ala Cart	319

G.S.T. not included - Prices subject to change without notice

1991

WHAT WERE YOU DOING FOR YOU
DOPPLER COMPUTER CENTRE

DOPPLER

COMPUTER CENTRE

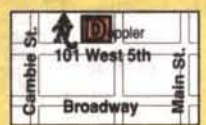

CALL US

ANY DAY

875-0261 Sales & Service
727-3414 From Victoria
1-800-661-2805 Anywhere in B.C.
101 West 5th at Manitoba St., Vancouver
Fax number 875-8558 • Doppler dial in Bulletin Board 377

FOLD ALONG THIS LINE FOR YOUR READING CONVENIENCE

ANOVATION

A Monthly Newsletter From



ANO Office Automation

READY, SET, GONE...

The 486 story.

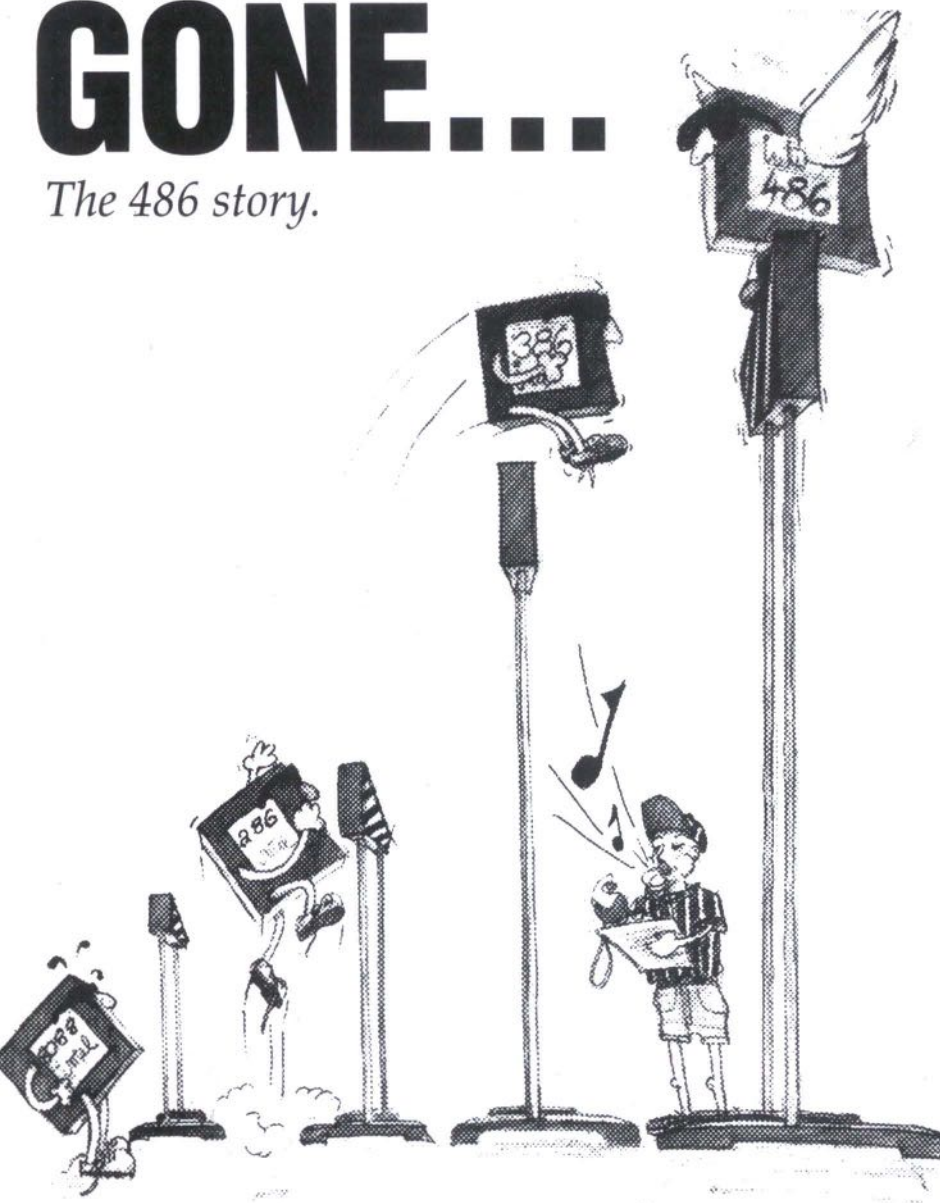

T

echnical advancements have affected each and every one of us in one way or the other.

Whether it be an automated banking machine, or microwave ovens, the effects are outstanding.

The computer industry has been both blessed and brow beaten by new technologies. Everyday we hear of new ways of doing things to make us either look better or work more productively. Much of this is simple hog wash and can be taken with a grain of salt. Others such as Intel's i486 microprocessor, are truly destined to shape our lives.

In this article we will discuss the technology behind Intel's i486 processor family, where they fit into business, and why they are destined to become the next desktop standards.

INSIDE THIS ISSUE

New AST Portable	3
Training	4
Tech Talk	4
Viruses	5
Product Line	6
Run Wild	7
ANotations	8



Simply Put

The i486 microprocessor is simply a spruced up version of the 386 processor developed in the mid 1980's. By integrating onto one chip what before took three chips, and throwing in a couple splashes of speed enhancement routines (kind of like silicon steroids), Intel was able to improve processing performance by leaps and bounds.

The i486 is kind of the mini-mall of computing. Instead of having three shops in three different areas, Intel took all three stores and stuck them under one roof, added a drive through check out, and a "9-item or less" express lane.

More technically speaking, a microprocessor, cache co-processor, and math/numeric co-processor were integrated together into one chip. By doing so Intel was able to do three things.

First, by putting all of the silicon onto one chip, they eliminated the need to develop pal chips to enhance the processor's performance. This was now left up to third party developers to do so at their own time and expense.

Secondly, costs could be kept down, by only requiring a single manufacturing source rather than three.

Finally, Intel no longer had to compete against such companies as Cyrix and IIT in the math/numeric co-processor market.

The two other enhancements which the i486 introduced include Pipelining and Burst Mode. Pipelining technology simply breaks down

AST RESEARCH BENCHMARK SCHEDULE

System	Power Meter MIPS	Landmark
Bravo 286	1.6	10.3
Premium 286	2.0	12.7
Bravo 386sx	2.59	18.6
Premium 386sx/16	3.3	23.1
Premium 386/25	5.18	40.5
Premium 386/33	6.77	54.0
Premium 486/25	10.7	112.0
Premium 486/33	N/A	140.0

complex instructions into a series of simple ones. Resulting in dramatic performance improvements in both floating point and standard processing. Burst Mode is a technique used to improve the transfer of data between the processor and main system memory.

The Microprocessor

So far we have assumed that you were already aware of what exactly the microprocessor's function was within your system. Simply put, the processor is the heart and soul of any computer system. It is to a computer what the central nervous system is to the human body.

The operating system which you use (whether it be MS DOS, OS/2, MACH, Thoroughbred, Banyan Vines, Unix, or Novell), is directly related to the microprocessor in the computer. For example, the MACH operating system used in the Apple Mac (which use Motorola processors) cannot be loaded onto a machine run by an Intel processor without major modification. Likewise, MS DOS cannot be installed onto a Mac since the operating system was developed

for the Intel family of processors.

The Math Co-Processor

Computers are basically simple animals that do an excellent job of turning numbers into meaningful pieces of information. However, when these numbers turn into complex calculations the microprocessor begins to bog down. Which is why Intel developed an add on chip known

as the math or numeric co-processor to run along side of the microprocessor.

In order for an application to take advantage of the math co-processor's capabilities, it must have the necessary code built in to make the necessary requests. Most basic applications such as word processors have no real requirements for floating point calculations, thus they will not use the math chip. Other programs, such as CAD/CAM, spreadsheets, GUIs (Graphic User Interface), multi-tasking operating environments, and animation, rely heavily on floating point. Thus a math chip is almost a prerequisite.

The Cache Co-Processor

Intel created the 82385 cache co-processor as a way to help slower system memory (RAM) keep up with the incredible speeds of the 386 processor. Using a buffer of high speed RAM (5 to 8 times faster than system memory) between the processor and system memory, greater system performance was immediately recognized.

(Continued on page 5)



AST ON THE GO



Have you ever read an ad in the newspaper for a car that was perfect for your budget, only to be disappointed to see what you were actually getting for your dollar? Or saw an outstanding price for a computer only to get to the store and have a sales rep try to push you into something different because the system in the paper wasn't very good?

I've been witness to both of these, which would probably explain how skeptical I was when I saw the price tag on AST Research's new Exec 386sx/20 Portable Notebook. Word in the company was that AST's first entry in the portable market would resell at ANO for well under \$4,000.00. "So what is the catch?" I asked.

Turns out the AST Premium Exec 386sx/20 comes standard with more features than most similarly equipped desktop systems (only 75 pounds lighter).

BIG FEATURES

Born to fly, the Exec packs a lot of power. Boasting a 20 Megabyte lightning fast hard drive, 2MB of high performance RAM (expandable to 8MB), an Intel 80386SX 20MHz processor, 3.5" 1.44MB floppy drive, industry standard interface ports, stunning 32 grey scale VGA display system, a 3 hour internal battery, loads of software, and a wide assortment of options.

One of its most notable (pardon the pun) features is definitely the video display system. Providing

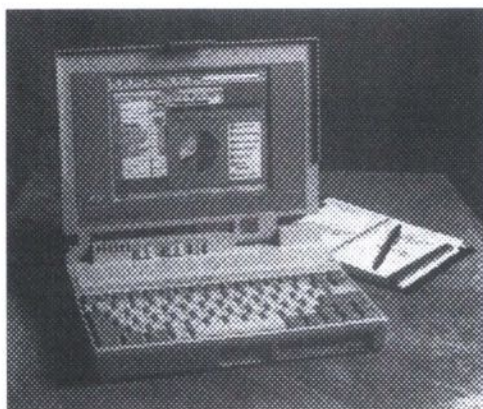

640x480 monochrome text and graphics resolution, the advanced CCFT (Cold Cathode Fluorescent Tube) backlight provides up to three times longer life than older EL (Electroluminescent) technology. The new supertwist LCD display provides a clear, paperwhite screen that's lighter and brighter than ever before.

The high-contrast display is easy to read and the adjustable display angle provides maximum viewing comfort.

NO PUNCHES PULLED

Instead of simply putting together just another portable AST decided that the comfort of the user was of primary importance. One way they improved this was with a System Suspend/Resume feature.

This allows the user to save the operating state of the computer, including the contents of RAM and the display, by simply closing the cover with the power switch on. With the cover closed all system components will be powered down (or put to sleep)

except the memory and all system activity/processing will be suspended. When the cover is reopened, the computer's operating status will resume at the point the cover was closed.

MORE TO COME

Although the Exec 386sx/20 is the first portable from AST, it is most definitely not the last. Although not shipping, AST will also be offering a 12MHz 286 version soon.

Both the 286 and 386sx will be available with either a 20MB or 40MB hard drive. Currently, however, only the 20MB 386sx/20 is in mass production.

286 UPGRADEABLE

The Premium Exec notebooks are designed around a modular architecture which separates the processor component from the motherboard. This design - pioneered by AST in desktop computers - offers the ability to simply interchange the Premium Exec 286/12's processor module with a 386sx/20 processor module. Without compromising performance or features.

AST QUALITY

Premium Exec notebook computers offer the same quality, reliability and compatibility as AST's Premium and Bravo desktop computers. AST's dedication to producing high-performance computers combining value and extra features is evident in both Premium Exec notebooks.





British Columbia Institute of Technology (BCIT)

PROFESSIONAL TRAINING

ANO Professional Training

Date	Course	Course #	Duration	Fee	Date	Course	Location	Fee
Feb 11	dBase IV Level 1	21578	4 wks.	\$ 161.	Feb 09	Intro. to MS DOS	R/K/E	Call
Feb 11	ACCPAC A/R	21648	4 wks.	\$ 161.	Feb 23	Intro. to WordPerfect	R/K/E	Call
Feb 12	dBase IV Level 2	10246	4 wks.	\$ 161.	Mar 09	Intro. to MS DOS	R/K/E	Call
Feb 12	Lotus 1-2-3 Level 1	10130	4 wks.	\$ 161.	Mar 23	Intro. to WordPerfect	R/K/E	Call
Feb 13	WordPerfect Level 2	10065	4 wks.	\$ 161.	Apr 13	Intro. to MS DOS	R/K/E	Call
Feb 14	Lotus 1-2-3 Level 2	10194	4 wks.	\$ 161.	Apr 27	Intro. to WordPerfect	R/K/E	Call
Feb 14	WordPerfect Level 1	10026	4 wks.	\$ 161.	May 11	Intro. to MS DOS	R/K/E	Call
Feb 27	Introduction DOS	09991	6 wks.	\$ 241.	May 25	Intro. to WordPerfect	R/K/E	Call
Mar 11	Ventura Publishing	21630	4 wks.	\$ 161.	<i>If your organization is looking for specialized training, or require fully equipped classroom facilities, let ANO give you a hand. Talk to your ANO rep for further information.</i>			
Mar 11	ACCPAC A/P	21656	4 wks.	\$ 161.				
Mar 12	dBase IV Level 3	10260	4 wks.	\$ 161.				
Mar 12	Lotus 1-2-3 Level 2	10209	4 wks.	\$ 161.	R = Richmond • K = Kelowna • E = Edmonton			
<i>Call BCIT at 434-1610 to register.</i>					<i>Call your nearest ANO office for further information.</i>			

Q. I have heard a lot about RISC microprocessors. What is the difference between a RISC microprocessor and the processor inside my AST PC?

A. Basically you are asking what is the difference between RISC (Reduced Instruction Set Computing) and CISC (Complex Instruction Set Computing)?

The primary difference (aside from any proprietary state of the art changes adopted by RISC chip set manufacturer's) is in the way that instructions are handled. Under RISC, when an application requests a process to be executed, it does so in small simple chunks - known as instructions.

The theory behind RISC, is that a processor can best perform when it is executing smaller easier to swallow pieces.

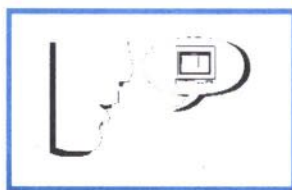

TECH • TALK

WITH
KEN NG

RISC processors are most common in workstation type computers developed by Data General, Sun, IBM, MIPS, and Hewlett Packard,

CISC technology, on the other hand, is the exact opposite. Instead of executing a bunch of small simple instructions, the applications provide instructions that are

more complex. The technology is most prominent in PC's powered by Intel 80000 series (not including the i860) and Motorola 68000 series of processors.

NOTE: CISC technology has been modified slightly with Intel's introduction of Pipelining in the i486 family of microprocessors. Essentially, the application provides a complex instruction which the i486 processor then breaks down and executes.

Should you have any questions for Tech Talk, please feel free to send them to:

ATTENTION: TECH TALK
c/o ANO Office Automation
110 - 11100 Voyageur Way
Richmond, B.C.
V6X 3E1





THE COMMON PC COLD



Viruses have become a multi-million dollar industry in North America. Many Fortune 1000 companies spend an absolute ton of time, money and resources protecting their PC investments from these annoying, not to mention costly, byproducts of disturbed minds.

A virus is simply a set of programming instructions that are embedded into an otherwise normal piece of software. When the software is run, it begins spreading itself throughout other applications, corrupting them and making them inoperable. The most common target for a virus is the COMMAND.COM file. Since the COMMAND.COM is the heart and soul of Microsoft's DOS, a virus is most likely to gain the best results by hitting it.

Not all viruses are easily identifiable. For ex-

ample, a virus may corrupt files in such a way as to simply change the numbers in a spreadsheet file or certain words in a word processing document. The more destructive ones, such as the "Stoned" or "Jerusalem" virus can raise havoc and make your hard drive unusable (without reformatting). In most circumstances users think that there is a hardware problem such as memory faults are errors reading the hard disk, when in fact a virus is the root of the problem.

Fortunately hope is available. ANO Office Automation's service and support groups offer a two step approach to "Safe Computing". The first is via a product from McAfee Associates called Pro-Scan. Pro-Scan scans systems and individual diskettes and identifies all files infected with known viruses. It removes viruses from all infected files and repairs

infected programs where possible. In addition, it identifies and removes any boot sector or partition table virus that may be present. Viruses in memory will also be disabled and removed.

Step 2 is a utility from Paul Mace Software, aptly title MACE VACCINE. Essentially it is a defence mechanism against viral infection. Mace Vaccine prevents viral reproduction and damage by stopping unauthorized alteration of vital disk areas, including the COMMAND.COM file, and by checking programs for changes before allowing them to run.

By following this simple two step approach, you will be able to help in the war against computer viruses.



(Tracking PC Evolution Cont'd from page 2)

The cache co-processor works something like this. Whenever the microprocessor reads a record or piece of data in for processing, it immediately makes a mirror image of that same piece of information into the high speed static RAM cache. Upon subsequent reads for data, chances are very high that it will ask for that same piece of data. Thus drastically improving the response time between retrieval and processing.

By introducing a built in 8Kb caching system into the i486 chip, there was no longer a requirement to rely on an outside source to improve processor and memory relations. However, many PC manufacturer's still include their own proprietary caching scheme to further improve data throughput.

Unlike a math co-processor, the cache co-processor is not dependent upon the applications themselves.

THE SOFTWARE QUESTION

One of the biggest concerns by PC users, has been a lack of software which take advantage of the 386 and i486 processors. This, however, is being squelched by an on-slot of new products. Leading edge applications such as Windows 3.0, Autodesk Animator, Novell/386, OS/2, Paradox, and Wingz, are hammering home the fact that the 386 and i486 proc-

essors are here to stay.

Unix users will find the i486 a definite treat. Since the latest releases of Unix System V for the PC are designed strictly for 386 and 486 based systems, all of the software operating under it will as well. Some of the most infamous of these applications include WordPerfect, Oracle, Informix, AutoCAD, Lotus, and Foxbase.

IMPLEMENTING THE 486

Although originally designed for high performance users, the i486 is sneaking onto the desktops of everyday business users. AST's Bravo i486/25 is a perfect example of this. Designed as a general business system, the Bravo i486/25 packs the power of a workstation, at a price equal to or less than comparable 386 systems.

High performance users running OS/2, Unix, Novell, 3DCAD, simulation, scientific, or animation applications and operating environments, should have no hesitation jumping right into the 486 forum.

For the general business population it is important that you analyze your

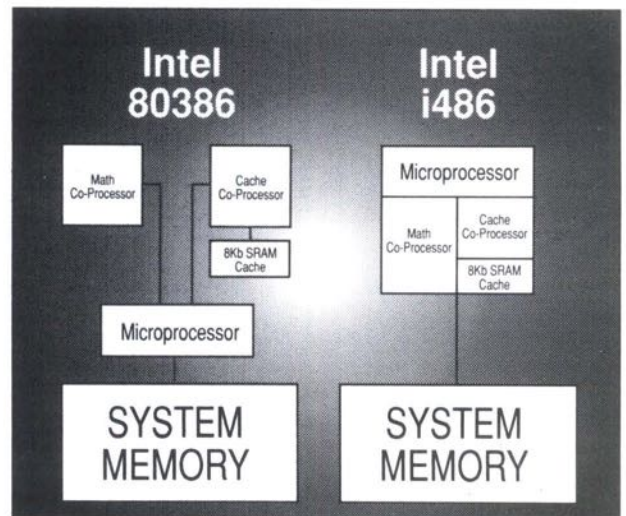

current and future needs. If your needs are word processing and basic spreadsheet then look no further than a 386sx. However, if graphics such as Windows 3.0, OS/2, or Open Desktop are on your horizon, giving a 486 system a second look may be worth your while.

In brief, the Intel i486 family of processors is destined to become the desktop and file server of choice in 1991. From a price/performance standpoint it racks up impressive numbers, and should be given serious consideration.





ANO

PRODUCT LINE CHART

	Software	Personal Computers	Dot Printers	Portable Computers	Networking	Laser Printers	Plotters	Hard Drives	Communications	Monitors/Video	Peripherals
Aldus	•				•						
Anthem					•						
Artisoft					•						
Ashton-Tate	•										
AST Research		•		•	•			•	•		•
ATI Technologies					•			•	•		
Banyan Vines					•			•			
Borland	•										
Canon			•			•					•
Cardinal			•					•			
Citizen			•								
Colorado											•
Computer Associates	•										
Cyrix					•						•
DigiBoard	•				•			•			
Everdata		•								•	•
Everex		•		•				•	•		
Fifth Generation	•										
Hayes								•			
Hewlett Packard			•			•	•				
IIT											•
Intel						•		•			•
Logitech	•										•
Maxtor								•			•
Micropolis								•			•
Microsoft	•										•
Mountain		•	•	•		•		•		•	•
NEC		•									
Novell			•		•	•		•			
Okidata			•			•					
Pacific Data						•					
Plus Development								•			
Pure Data					•						
Quarterdeck	•					•					
Roland		•									
Samsung		•								•	
Santa Cruz Operations	•				•						
Sharp			•	•							
Summagraphics						•					•
Software Publishing	•										
TEAC											•
TVM										•	
US Robotics								•			
Western Digital					•			•			
WordPerfect	•										•
Wyse					•					•	
Xircom					•						
Zenith Data Systems		•		•						•	



M • A • R • K • E • T • P • L • A • C • E

LET YOUR IMAGINATION RUN WILD



\$3,295⁰⁰

Introducing The New ANO i486/25 Personal Computer

Once in a while a product comes along that gets people talking. We think this is one of them. For the last five years, ANO Office Automation has been providing Canadian businesses with solutions. Our commitment has always been to offering solid, leading edge systems that solve problems.

With business applications becoming more and more demanding, the ANO

i486/25 Personal Computer meets these new requirements. Designed with performance in mind, this new speed demon fits in beautifully as a graphics workstation for desktop publishing or animation, a Unix console, a Netware File Server, a CAD station, or whatever your imagination can think up.

The ANO i486/25 - all the power and glory at a budget pleasing price.

***NOTE: Prices listed are FOB Vancouver, and are subject to change without notice. Prices may vary from location to location.

WILD



ANOVATIONS

WELCOME ABOARD

ANO Office Automation is proud to welcome two new additions to our rapidly growing team in Richmond, B.C. Mr. Edmond Kam, has been appointed to the position of Production Supervisor. He will be responsible for the co-ordination, scheduling, and planning in the system assembly area. Mr. Mike Winthrow has been added to our sales force to help provide the same professional service ANO clients have come to expect. We all wish them the very best here at ANO!

CA ANNOUNCEMENTS

According to Computer Associates

(CA), two new announcements are in the workings for their ACCPAC line of products. Users can look forward to a version 6.0 of their ACCPAC Plus Accounts Payable, as well as a release for Microsoft Windows. More announcements from CA will be highlighted in the following months in a new column entitled "CA NOTES".

COME SEE US

ANO Office Automation, in conjunction with Canon, Sharp Electronics, and Richmond Software (The Maximizer people), will be displaying the latest in portable offices at the annual Real Estate

Computer Show on February 14th, 1991 at the Italian Cultural Centre on Slocan Street in Vancouver. Hope to see you there!

CANON BJ-300 NOW IN

The new Canon BJ-300 narrow carriage printer is now in stock and ready to ship. After great anticipation, this latest offering from Canon will surely knock your socks off. Best of all its priced to please!



Reader Response Card



Contact: _____

Position: _____

Company: _____

Address: _____

City: _____

Prov: _____ Postal Code: _____

Phone: _____ Local: _____

Fax: _____

Please send me ANOVATION monthly:

Please have an ANO Rep contact me:

Please send me more information on: _____

- AST Exec Portables
- ANO i486/25 PC
- CA Accpac Products
- Canon BJ-300 Printer

- LAN Products
- ANO Office Automation
- ANO Training
- ANO On-Site Service

Suggestions: _____

ANO OFFICE AUTOMATION

Please mail to the ANO office nearest you:

ANO RICHMOND

#110-11100 Voyageur Way, Richmond B.C. V6X 3E1
Ph: (604) 276-8898

ANO VANCOUVER

#190-840 Howe Street, Vancouver B.C. V6Z 2M1
Ph: (604) 681-6165

ANO BURNABY

3571 Kingsway, Vancouver B.C. V5R 5L9
Ph: (604) 432-7077

ANO VANCOUVER ISLAND

#2-1026 Johnson Street, Victoria B.C. V8V 3N6
Ph: (604) 386-2204

ANO KELOWNA

#10-2070 Harvey Avenue, Kelowna B.C. V1Y 8R6
Ph: (604) 861-8300

ANO EDMONTON

10301-108th Street, Edmonton AB T5J 1L7
Ph: (403) 429-4990

ANO TORONTO

Unit #1 2nd Floor, 226 Esna Park Drive
Markham, ON L3R 1H3
Ph: (416) 479-1308

ANO OTTAWA

1181 Cecil Avenue, Ottawa ON K1H 7Z6
Ph: (613) 733-7110